

Data sheet | Item number: 750-363/040-000  
 Fieldbus Coupler EtherNet/IP; 4th generation; Extreme

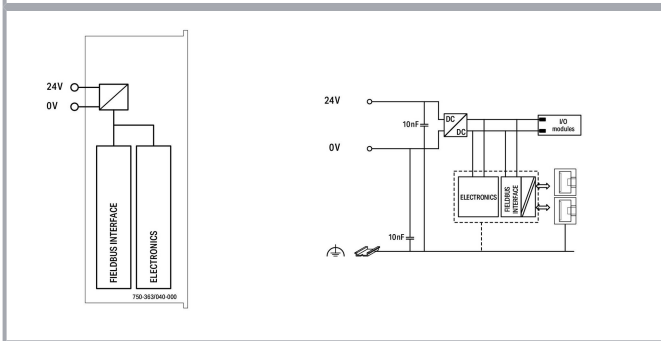

[www.wago.com/750-363/040-000](http://www.wago.com/750-363/040-000)

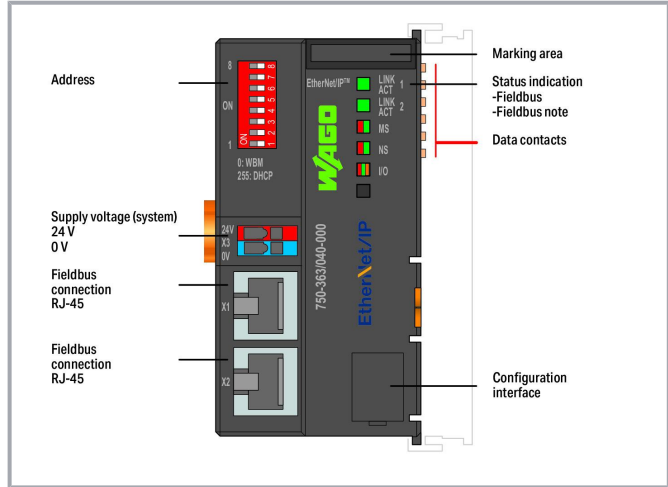

Subject to changes. Please also observe the further product documentation!

WAGO GmbH & Co. KG  
 Hansastr. 27  
 32423 Minden  
 Phone: +49571 887-0 | Fax: +49571 887-169  
 Email: [info.de@wago.com](mailto:info.de@wago.com) | Web: [www.wago.com](http://www.wago.com)

Do you have any questions about our products?  
 We are always happy to take your call at +49 (571) 887-44222.

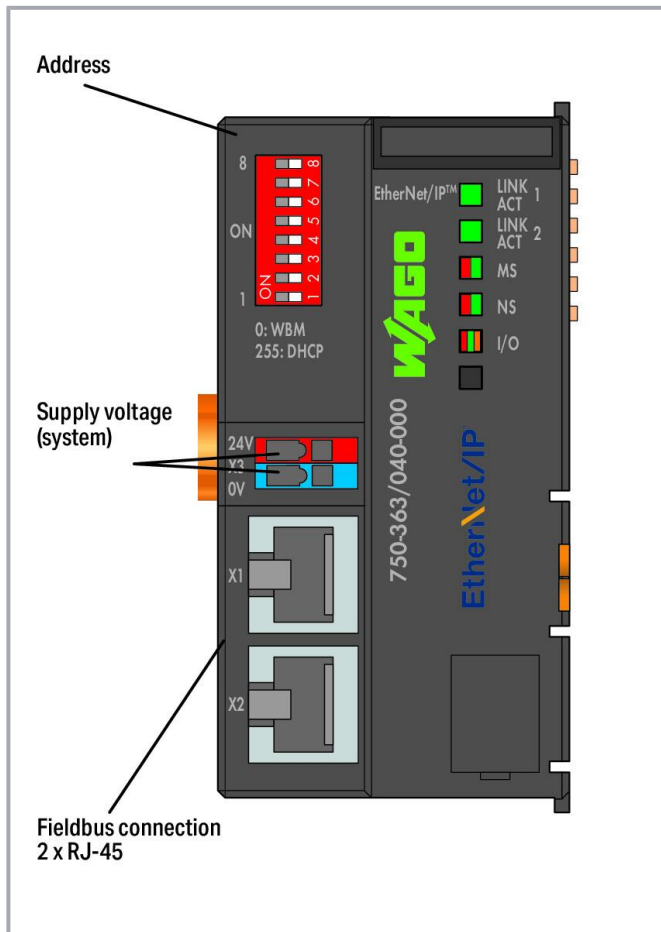

## Item description

The 750-363/040-000 EtherNet/IP™ Fieldbus Coupler connects the EtherNet/IP™ fieldbus system to the modular WAGO I/O System. The fieldbus coupler detects all connected I/O modules and creates a local process image.

Two ETHERNET interfaces and an integrated switch allow the fieldbus to be wired in a line topology, eliminating the need for additional network devices, such as switches or hubs.

Both interfaces support autonegotiation and Auto-MDI(X).

The DIP switch configures the last byte of the IP address and may be used for IP address assignment (DHCP, BootP, static).

The coupler is designed for fieldbus communication in EtherNet/IP™ networks. It also supports a wide variety of standard ETHERNET protocols (e. g., HTTP(S), BootP, DHCP, DNS, SNMP, (S)FTP).

An integrated Webserver provides user configuration options, while displaying the coupler's status information.

The system supply is provided directly by the coupler. The field supply is provided via a separate supply module.

**The device is ideal for operation in extreme environments thanks to:**

- An extended temperature range
- Greater immunity to impulse voltages and electromagnetic interference
- Higher vibration and shock resistance

Subject to changes. Please also observe the further product documentation!

WAGO GmbH & Co. KG

Hansastr. 27

32423 Minden

Phone: +49571 887-0 | Fax: +49571 887-169

Email: [info.de@wago.com](mailto:info.de@wago.com) | Web: [www.wago.com](http://www.wago.com)

Do you have any questions about our products?

We are always happy to take your call at +49 (571) 887-44222.



## Data

### Technical data

Communication	EtherNet/IP™
ETHERNET protocols	HTTP(S) BootP DHCP DNS SNTP FTP(S) SNMP
Baud rate	10/100 Mbit/s
Transmission medium	Twisted Pair S-UTP; 100 Ω; Cat. 5; 100 m maximum cable length
Transmission performance	Class D per EN 50173
Number of modules per node (max.)	64
Input and output process image (fieldbus) max.	1020 words/1020 words
Supply voltage (system)	24 VDC; via pluggable connector (CAGE CLAMP® connection); Derating must be observed!
Current consumption (5 V system supply)	350 mA
Total current (system supply)	700 mA
Input current (typ.) at nominal load (24 V)	280 mA
Power supply efficiency (typ.) at nominal load (24 V)	90 %
Rated surge voltage	1 kV
Derating	Derating (supply voltage): Ambient temperatures under laboratory conditions: (-25 ... +30 %); for -40 ... +55 °C: 24 V (-25 ... +20 %); for +55 ... +70 °C: 24 V (-25 ... +10 %); Lower limit in all temperature ranges: -27.5 % (including 15 % residual ripple)

### Connection data

Connection technology: communication/fieldbus	EtherNet/IP™; 2 x RJ-45
Connection technology: system supply	2 x CAGE CLAMP®
Connection technology: device configuration	1 x Male connector; 4-pole
Connection type 1	System supply
Solid conductor	0.25 ... 1.5 mm² / 24 ... 16 AWG
Fine-stranded conductor	0.25 ... 1.5 mm² / 24 ... 16 AWG
Strip length	5 ... 6 mm / 0.2 ... 0.24 inches

Subject to changes. Please also observe the further product documentation!



## Physical data

Width	49.5 mm / 1.949 inches
Height	96.8 mm / 3.811 inches
Depth	71.9 mm / 2.831 inches
Depth from upper-edge of DIN-rail	64.7 mm / 2.547 inches

## Mechanical Data

Mounting type	DIN-35 rail
---------------	-------------

## Material Data

Housing material	Polycarbonate; polyamide 6.6
Fire load	1.412 MJ
Weight	103.9 g
Conformity marking	CE

## Environmental requirements

Ambient temperature (operation)	-40 ... +70 °C
Ambient temperature (storage)	-40 ... +85 °C
Protection type	IP20
Pollution degree	2 per IEC 61131-2
Operating altitude	without temperature derating: 0 ... 2000 m; with temperature derating: 2000 ... 5000 m (0.5 K/100 m); 5000 m (max.)
Mounting position	horizontal (standing/lying); vertical
Relative humidity (without condensation)	95 %
Relative humidity (with condensation)	Short-term condensation per Class 3K7/IEC EN 60721-3-3 and E-DIN 40046-721-3 (except for wind-driven precipitation, water and ice formation)
Vibration resistance	per IEC 60068-2-6 (acceleration: 5g), EN 60870-2-2, IEC 60721-3-1, -3, EN 50155; EN 61373
Shock resistance	per IEC 60068-2-27 (15g/11 ms/half-sine/1,000 shocks; 25g/6 ms/1,000 shocks), EN 50155, EN 61373
EMC immunity to interference	per EN 61000-6-1, -2; EN 61131-2; marine applications; EN 50121-3-2; EN 50121-4, -5; EN 60255-26; EN 60870-2-1; EN 61850-3; IEC 61000-6-5; IEEE 1613; VDEW: 1994
EMC emission of interference	per EN 61000-6-3, -4, EN 61131-2, EN 60255-26, marine applications, EN 60870-2-1, EN 61850-3, EN 50121-3-2, EN 50121-4, -5

Subject to changes. Please also observe the further product documentation!

WAGO GmbH & Co. KG  
 Hansastr. 27  
 32423 Minden  
 Phone: +49571 887-0 | Fax: +49571 887-169  
 Email: [info.de@wago.com](mailto:info.de@wago.com) | Web: [www.wago.com](http://www.wago.com)

Do you have any questions about our products?  
 We are always happy to take your call at +49 (571) 887-44222.



Exposure to pollutants	per IEC 60068-2-42 and IEC 60068-2-43
Permissible H <sub>2</sub> S contaminant concentration at a relative humidity 75 %	10 ppm
Permissible SO <sub>2</sub> contaminant concentration at a relative humidity 75 %	25 ppm

### Commercial data

ETIM 8.0	EC001603
ETIM 7.0	EC001603
PU (SPU)	1 pcs
Packaging type	box
Country of origin	DE
GTIN	4055143978286
Customs tariff number	85371091990

### Environmental Product Compliance

CAS-No.	1314-23-4 1317-36-8 693-98-1 7439-92-1 79-94-7
REACH Candidate List Substance	2,2',6,6'-tetrabromo-4,4'-isopropylidenediphenol 2-methylimidazole Lead Lead monoxide Perfluorobutane sulfonic acid (PFBS) and its salts Zirconium Oxide
RoHS Compliance Status	Compliant, With Exemption
RoHS Exemption	6(c) 7(a) 7(c)-I 7(c)-II
SCIP notification number (Austria)	14f0d494-00a6-4374-aac8-7489f75aec50
SCIP notification number (Belgium)	56ad916e-cef9-4276-9bdc-5e1529c22d5b
SCIP notification number (Bulgaria)	cb963eaa-2794-4ed3-9ecb-e62922328822
SCIP notification number (Czech Republic)	01e81def-ccf6-47c5-86b5-9bf06c4d7cd4
SCIP notification number (Denmark)	2716f5cf-70e0-498d-8092-97cf23c84bad
SCIP notification number (Finland)	0eca8c06-31d3-4e46-8c97-0c17fb21a654
SCIP notification number (France)	f23bfcfb-e644-497d-9add-93f30b0468fd
SCIP notification number (Germany)	071e2f8c-e40d-4154-8b6c-34ce333bfac6

Subject to changes. Please also observe the further product documentation!





WAGO GmbH & Co. KG  
Hansastr. 27  
32423 Minden  
Phone: +49571 887-0 | Fax: +49571 887-169  
Email: [info.de@wago.com](mailto:info.de@wago.com) | Web: [www.wago.com](http://www.wago.com)

Do you have any questions about our products?  
We are always happy to take your call at +49 (571) 887-44222.



SCIP notification number (Hungary)	2f06ef12-3362-44bf-b5c4-8d3bae4fa5db
SCIP notification number (Italy)	179ffb4b-5ea4-4664-9c69-18d08db9c0b9
SCIP notification number (Netherlands)	7bc4ab68-d58d-4c24-ab80-3eb8fcef6905
SCIP notification number (Poland)	e1267802-21d6-4966-a80e-beb2d7ace044
SCIP notification number (Romania)	8a091b57-7056-4ef4-a6fd-b57d08bdce33
SCIP notification number (Sweden)	dacbeb64-9eb6-4ed3-b97f-414ef44f957d

## Approvals / Certificates

### General approvals

Logo	Approval	Additional Approval Text	Certificate name
	EAC Brjansker Zertifizierungsstelle	TP TC 020/2011	EAC RU C-DE.AM02. B.00087 /19
	EAC Brjansker Zertifizierungsstelle	TP TC 012/2011	EAC RU C-DE.AZ58. B.2173-21 e (2Ex e IIC T4 Gc X)
	KC National Radio Research Agency	Article 58-2, Clause 3	MSIP-REM-W43-FBC750
	UL Underwriters Laboratories Inc. (ORDINARY LOCATIONS)	-	E175199

### Declarations of conformity and manufacturer's declarations

Logo	Approval	Additional Approval Text	Certificate name
	EU-Declaration of Conformity WAGO GmbH & Co. KG	-	-
	UK-Declaration of Conformity WAGO GmbH & Co. KG	-	-

### Approvals for marine applications

Certificate



Subject to changes. Please also observe the further product documentation!

WAGO GmbH & Co. KG  
 Hansastr. 27  
 32423 Minden  
 Phone: +49571 887-0 | Fax: +49571 887-169  
 Email: [info.de@wago.com](mailto:info.de@wago.com) | Web: [www.wago.com](http://www.wago.com)

Do you have any questions about our products?  
 We are always happy to take your call at +49 (571) 887-44222.







Logo	Approval	Additional Approval Text	name
	<b>DNV</b> DNV Germany GmbH	DNV-CG-0339, Aug. 2021	TAA00000Y7

#### Approvals for hazardous areas

Logo	Approval	Additional Approval Text	Certificate name
	<b>CCC</b> CNEX	CNCA-C23-01	2020312310000214 (Ex ec IIC T4 Gc)
	<b>UKEx</b> WAGO GmbH & Co. KG	EN 60079-0	UKCA_WAGO22UKEX005X_ec
	<b>UL</b> Underwriters Laboratories Inc. (HAZARDOUS LOCATIONS)	UL 121201	E198726 Sec.1

#### Optional accessories

##### Shield termination

Shield clamping saddles		
	<b>Item no.: 790-116</b> Shield clamping saddle; 19 mm wide; diameter of compatible conductor; 7 ... 16 mm	<a href="http://www.wago.com/790-116">www.wago.com/790-116</a>
	<b>Item no.: 790-124</b> Shield clamping saddle; 27 mm wide; diameter of compatible conductor; 6 ... 24 mm	<a href="http://www.wago.com/790-124">www.wago.com/790-124</a>
	<b>Item no.: 790-108</b> Shield clamping saddle; 11 mm wide; diameter of compatible conductor; 3 ... 8 mm	<a href="http://www.wago.com/790-108">www.wago.com/790-108</a>
	<b>Item no.: 790-140</b> Shield clamping saddle; diameter of compatible conductor	<a href="http://www.wago.com/790-140">www.wago.com/790-140</a>
	<b>Item no.: 790-216</b> Shield clamping saddle; 21.8 mm wide; 6 ... 16 mm	<a href="http://www.wago.com/790-216">www.wago.com/790-216</a>
	<b>Item no.: 790-220</b> Shield clamping saddle; 30 mm wide; 6 ... 20 mm	<a href="http://www.wago.com/790-220">www.wago.com/790-220</a>
	<b>Item no.: 790-208</b> Shield clamping saddle; 12.4 mm wide; 3 ... 8 mm	<a href="http://www.wago.com/790-208">www.wago.com/790-208</a>

##### Carrier rail

Subject to changes. Please also observe the further product documentation!

WAGO GmbH & Co. KG  
Hansastr. 27  
32423 Minden  
Phone: +49571 887-0 | Fax: +49571 887-169  
Email: [info.de@wago.com](mailto:info.de@wago.com) | Web: [www.wago.com](http://www.wago.com)



Do you have any questions about our products?  
We are always happy to take your call at +49 (571) 887-44222.

## Mounting accessories

	<b>Item no.: 210-197</b> Steel carrier rail; 35 x 15 mm; 1.5 mm thick; 2 m long; slotted; similar to EN 60715; silver-colored	<a href="http://www.wago.com/210-197">www.wago.com/210-197</a>
	<b>Item no.: 210-198</b> Copper carrier rail; 35 x 15 mm; 2.3 mm thick; 2 m long; unslotted; according to EN 60715; copper-colored	<a href="http://www.wago.com/210-198">www.wago.com/210-198</a>
	<b>Item no.: 210-504</b> Steel carrier rail; 35 x 7.5 mm; 1 mm thick; 2 m long; slotted; galvanized; according to EN 60715; silver-colored	<a href="http://www.wago.com/210-504">www.wago.com/210-504</a>
	<b>Item no.: 210-505</b> Steel carrier rail; 35 x 7.5 mm; 1 mm thick; 2 m long; unslotted; galvanized; according to EN 60715; silver-colored	<a href="http://www.wago.com/210-505">www.wago.com/210-505</a>
	<b>Item no.: 210-506</b> Steel carrier rail; 35 x 15 mm; 1.5 mm thick; 2 m long; unslotted; galvanized; similar to EN 60715; silver-colored	<a href="http://www.wago.com/210-506">www.wago.com/210-506</a>
	<b>Item no.: 210-508</b> Steel carrier rail; 35 x 15 mm; 1.5 mm thick; 2 m long; slotted; galvanized; similar to EN 60715; silver-colored	<a href="http://www.wago.com/210-508">www.wago.com/210-508</a>
	<b>Item no.: 210-113</b> Steel carrier rail; 35 x 7.5 mm; 1 mm thick; 2 m long; unslotted; according to EN 60715; silver-colored	<a href="http://www.wago.com/210-113">www.wago.com/210-113</a>
	<b>Item no.: 210-118</b> Steel carrier rail; 35 x 15 mm; 2.3 mm thick; 2 m long; unslotted; according to EN 60715; silver-colored	<a href="http://www.wago.com/210-118">www.wago.com/210-118</a>
	<b>Item no.: 210-112</b> Steel carrier rail; 35 x 7.5 mm; 1 mm thick; 2 m long; slotted; according to EN 60715; "Hole width 25 mm; silver-colored	<a href="http://www.wago.com/210-112">www.wago.com/210-112</a>
	<b>Item no.: 210-114</b> Steel carrier rail; 35 x 15 mm; 1.5 mm thick; 2 m long; unslotted; similar to EN 60715; silver-colored	<a href="http://www.wago.com/210-114">www.wago.com/210-114</a>
	<b>Item no.: 210-115</b> Steel carrier rail; 35 x 7.5 mm; 1 mm thick; 2 m long; slotted; according to EN 60715; "Hole width 18 mm; silver-colored	<a href="http://www.wago.com/210-115">www.wago.com/210-115</a>
	<b>Item no.: 210-196</b> Aluminum carrier rail; 35 x 8.2 mm; 1.6 mm thick; 2 m long; unslotted; similar to EN 60715; silver-colored	<a href="http://www.wago.com/210-196">www.wago.com/210-196</a>









## Marking accessories

## Marker

	<b>Item no.: 2009-145/000-006</b> Mini-WSB Inline; for Smart Printer; 1700 pieces on roll; stretchable 5 - 5.2 mm; plain; snap-on type; blue	<a href="http://www.wago.com/2009-145/000-006">www.wago.com/2009-145/000-006</a>
	<b>Item no.: 2009-145</b> Mini-WSB Inline; for Smart Printer; 1700 pieces on roll; stretchable 5 - 5.2 mm; plain; snap-on type; white	<a href="http://www.wago.com/2009-145">www.wago.com/2009-145</a>

Subject to changes. Please also observe the further product documentation!

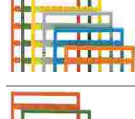
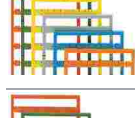
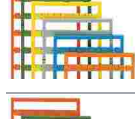
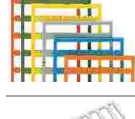
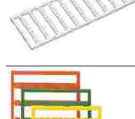

	<b>Item no.: 2009-145/000-002</b> Mini-WSB Inline; for Smart Printer; 1700 pieces on roll; stretchable 5 - 5.2 mm; plain; snap-on type; yellow	<a href="http://www.wago.com/2009-145/000-002">www.wago.com/2009-145/000-002</a>
	<b>Item no.: 2009-145/000-007</b> Mini-WSB Inline; for Smart Printer; 1700 pieces on roll; stretchable 5 - 5.2 mm; plain; snap-on type; gray	<a href="http://www.wago.com/2009-145/000-007">www.wago.com/2009-145/000-007</a>
	<b>Item no.: 2009-145/000-005</b> Mini-WSB Inline; for Smart Printer; 1700 pieces on roll; stretchable 5 - 5.2 mm; plain; snap-on type; red	<a href="http://www.wago.com/2009-145/000-005">www.wago.com/2009-145/000-005</a>
	<b>Item no.: 2009-145/000-012</b> Mini-WSB Inline; for Smart Printer; 1700 pieces on roll; stretchable 5 - 5.2 mm; plain; snap-on type; orange	<a href="http://www.wago.com/2009-145/000-012">www.wago.com/2009-145/000-012</a>
	<b>Item no.: 2009-145/000-023</b> Mini-WSB Inline; for Smart Printer; 1700 pieces on roll; stretchable 5 - 5.2 mm; plain; snap-on type; green	<a href="http://www.wago.com/2009-145/000-023">www.wago.com/2009-145/000-023</a>
	<b>Item no.: 2009-145/000-024</b> Mini-WSB Inline; for Smart Printer; 1700 pieces on roll; stretchable 5 - 5.2 mm; plain; snap-on type; violet	<a href="http://www.wago.com/2009-145/000-024">www.wago.com/2009-145/000-024</a>
	<b>Item no.: 248-501/000-006</b> Mini-WSB marking card; as card; not stretchable; plain; snap-on type; blue	<a href="http://www.wago.com/248-501/000-006">www.wago.com/248-501/000-006</a>
	<b>Item no.: 248-501/000-007</b> Mini-WSB marking card; as card; not stretchable; plain; snap-on type; gray	<a href="http://www.wago.com/248-501/000-007">www.wago.com/248-501/000-007</a>
	<b>Item no.: 248-501/000-002</b> Mini-WSB marking card; as card; not stretchable; plain; snap-on type; yellow	<a href="http://www.wago.com/248-501/000-002">www.wago.com/248-501/000-002</a>
	<b>Item no.: 248-501/000-012</b> Mini-WSB marking card; as card; not stretchable; plain; snap-on type; orange	<a href="http://www.wago.com/248-501/000-012">www.wago.com/248-501/000-012</a>
	<b>Item no.: 248-501</b> Mini-WSB marking card; as card; not stretchable; plain; snap-on type; white	<a href="http://www.wago.com/248-501">www.wago.com/248-501</a>
	<b>Item no.: 248-501/000-017</b> Mini-WSB marking card; as card; not stretchable; plain; snap-on type; light green	<a href="http://www.wago.com/248-501/000-017">www.wago.com/248-501/000-017</a>

Subject to changes. Please also observe the further product documentation!



**Item no.: 248-501/000-005**  
Mini-WSB marking card; as card; not stretchable; plain; snap-on type; red

[www.wago.com/248-501/000-005](http://www.wago.com/248-501/000-005)



**Item no.: 248-501/000-024**  
Mini-WSB marking card; as card; not stretchable; plain; snap-on type; violet

[www.wago.com/248-501/000-024](http://www.wago.com/248-501/000-024)



**Item no.: 248-501/000-023**  
Mini-WSB marking card; as card; not stretchable; plain; snap-on type; green

[www.wago.com/248-501/000-023](http://www.wago.com/248-501/000-023)

## System housing

### System enclosure



**Item no.: 850-814/002-000**  
IP65 enclosure; Sheet steel (RAL 7035); WxHxD (200x120x200 mm); without flange plate

[www.wago.com/850-814/002-000](http://www.wago.com/850-814/002-000)



**Item no.: 850-815/002-000**  
IP65 enclosure; Sheet steel (RAL 7035); WxHxD (300x120x200 mm); without flange plate

[www.wago.com/850-815/002-000](http://www.wago.com/850-815/002-000)



**Item no.: 850-816/002-000**  
IP65 enclosure; Sheet steel (RAL 7035); WxHxD (400x120x200 mm); without flange plate

[www.wago.com/850-816/002-000](http://www.wago.com/850-816/002-000)



**Item no.: 850-817/002-000**  
IP65 enclosure; Sheet steel (RAL 7035); WxHxD (600x120x200 mm); without flange plate

[www.wago.com/850-817/002-000](http://www.wago.com/850-817/002-000)



**Item no.: 850-825**  
IP65 enclosure; Aluminium (RAL 7032); WxHxD (160x100x160 mm); 9 x M12, 4 x M20

[www.wago.com/850-825](http://www.wago.com/850-825)



**Item no.: 850-826**  
IP65 enclosure; Aluminium (RAL 7032); WxHxD (240x100x160 mm); 4 x M20, 4 x M16, 14 x M12 cable grip

[www.wago.com/850-826](http://www.wago.com/850-826)



**Item no.: 850-827**  
IP65 enclosure; Aluminium (RAL 7032); WxHxD (320x100x160 mm); 4 x M20, 8 x M16, 17 x M12 cable grip

[www.wago.com/850-827](http://www.wago.com/850-827)



**Item no.: 850-827/002-000**  
IP65 enclosure; Aluminium (RAL 7035); WxHxD (320x100x160 mm); 4 x M20, 8 x M16, 17 x M12 cable grip

[www.wago.com/850-827/002-000](http://www.wago.com/850-827/002-000)



**Item no.: 850-826/002-000**  
IP65 enclosure; Aluminium (RAL 7035); WxHxD (240x100x160 mm); 4 x M20, 4 x M16, 14 x M12 cable grip

[www.wago.com/850-826/002-000](http://www.wago.com/850-826/002-000)



**Item no.: 850-828/002-000**  
IP65 enclosure; Aluminium (RAL 7035); WxHxD (480x100x160 mm); 4 x M20, 10 x M16, 35 x M12 cable grip

[www.wago.com/850-828/002-000](http://www.wago.com/850-828/002-000)

Subject to changes. Please also observe the further product documentation!

grip



**Item no.: 850-828**

IP65 enclosure; Aluminium (RAL 7032); WxHxD (480x100x160 mm); 4 x M20, 10 x M16, 35 x M12 cable grip [www.wago.com/850-828](http://www.wago.com/850-828)



**Item no.: 850-834**

IP65 enclosure; Polyester (RAL 7032); WxHxD (164x100x164 mm); 9 x M12, 4 x M20 [www.wago.com/850-834](http://www.wago.com/850-834)



**Item no.: 850-835**

IP65 enclosure; Polyester (RAL 7032); WxHxD (244x100x164 mm); 4 x M20, 4 x M16, 14 x M12 cable grip [www.wago.com/850-835](http://www.wago.com/850-835)



**Item no.: 850-836**

IP65 enclosure; Polyester (RAL 7032); WxHxD (324x100x164 mm); 4 x M20, 8 x M16, 17 x M12 cable grip [www.wago.com/850-836](http://www.wago.com/850-836)

### Communication

Communication cable



**Item no.: 750-923**

Configuration cable; USB connector; Length: 2.5 m [www.wago.com/750-923](http://www.wago.com/750-923)



**Item no.: 750-923/000-001**

Configuration cable; USB connector; Length: 5 m [www.wago.com/750-923/000-001](http://www.wago.com/750-923/000-001)

### Cables and pluggable connectors

Connector plug



**Item no.: 750-975**

ETHERNET RJ-45 connector, IP20; ETHERNET 10/100 Mbit/s; for field assembly [www.wago.com/750-975](http://www.wago.com/750-975)



**Item no.: 750-978/000-012**

Connector ETHERNET; RJ-45; Cat. 6A; straight; Code T568B; AWG 22; Strain relief [www.wago.com/750-978/000-012](http://www.wago.com/750-978/000-012)



**Item no.: 750-979/000-012**

Connector ETHERNET; RJ-45; Cat. 6A; angled; Code T568B; AWG 22; Strain relief [www.wago.com/750-979/000-012](http://www.wago.com/750-979/000-012)



**Item no.: 750-978/000-021**

Connector ETHERNET; RJ-45; Cat. 6A; straight; Code T568A; AWG 24; Strain relief [www.wago.com/750-978/000-021](http://www.wago.com/750-978/000-021)



**Item no.: 750-979/000-022**

Connector ETHERNET; RJ-45; Cat. 6A; angled; Code T568B; AWG 24; Strain relief [www.wago.com/750-979/000-022](http://www.wago.com/750-979/000-022)



**Item no.: 750-978/000-022**

Connector ETHERNET; RJ-45; Cat. 6A; straight; Code T568B; AWG 24; Strain relief [www.wago.com/750-978/000-022](http://www.wago.com/750-978/000-022)

Subject to changes. Please also observe the further product documentation!

WAGO GmbH & Co. KG

Hansastr. 27

32423 Minden

Phone: +49571 887-0 | Fax: +49571 887-169

Email: [info.de@wago.com](mailto:info.de@wago.com) | Web: [www.wago.com](http://www.wago.com)

Do you have any questions about our products?

We are always happy to take your call at +49 (571) 887-44222.



Item no.: 750-979/000-011

Connector ETHERNET; RJ-45; Cat. 6A; angled; Code T568A; AWG 22; Strain relief

[www.wago.com/750-979/000-011](http://www.wago.com/750-979/000-011)



Item no.: 750-979/000-021

Connector ETHERNET; RJ-45; Cat. 6A; angled; Code T568A; AWG 24; Strain relief

[www.wago.com/750-979/000-021](http://www.wago.com/750-979/000-021)



Item no.: 750-977/000-011

Connector ETHERNET; RJ-45; Cat. 6A; straight; Code T568A; AWG 22

[www.wago.com/750-977/000-011](http://www.wago.com/750-977/000-011)



Item no.: 750-978/000-011

Connector ETHERNET; RJ-45; Cat. 6A; straight; Code T568A; AWG 22; Strain relief

[www.wago.com/750-978/000-011](http://www.wago.com/750-978/000-011)



Item no.: 750-977/000-022

Connector ETHERNET; RJ-45; Cat. 6A; straight; Code T568B; AWG 24

[www.wago.com/750-977/000-022](http://www.wago.com/750-977/000-022)



Item no.: 750-977/000-012

Connector ETHERNET; RJ-45; Cat. 6A; straight; Code T568B; AWG 22

[www.wago.com/750-977/000-012](http://www.wago.com/750-977/000-012)



Item no.: 750-977/000-021

Connector ETHERNET; RJ-45; Cat. 6A; straight; Code T568A; AWG 24

[www.wago.com/750-977/000-021](http://www.wago.com/750-977/000-021)

## Downloads

### Documentation

#### Manual

Product Manual Fieldbus Coupler EtherNet/IP; 4th Generation; ECO; XTR extreme	V 1.1.0 2021 Sep 16	pdf 5.2 MB	Download
---	------------------------	---------------	----------

#### Bid Text

750-363/040-000 X81 - Datei		xml 9.3 kB	Download
--------------------------------	--	---------------	----------

750-363/040-000 docx - Datei		docx 17.2 kB	Download
---------------------------------	--	-----------------	----------

#### Instruction Leaflet

CCC Ex (Additional information) WAGO-I/O-SYSTEM *750-****/**40-****	2023 Apr 26	pdf 148.1 kB	Download
--	-------------	-----------------	----------

Subject to changes. Please also observe the further product documentation!



### Additional Information

Disposal and Recycling Electrical and electronic equipment, Batteries, Packaging	V 1.1.0 2022 Aug 18	pdf 2.2 MB	Download
---	------------------------	---------------	----------

### System Description

System Manual XTR Basic conditions and recommendations for higher operational safety	V 2.0.0 2022 Sep 14	pdf 8.0 MB	Download
---	------------------------	---------------	----------

750 XTR Series I/O-System – General Product Information		pdf 743.5 kB	Download
---	--	-----------------	----------

### Engineering-Software

#### Configuration and Commissioning Software

(759-316) WAGO Ethernet Settings / Serie 750	06.18.01.01 2023 Feb 28	zip 27.3 MB	Download
--	----------------------------	----------------	----------

### CAD/CAE-Data

#### CAD data

2D/3D Models 750-363/040-000		URL	Download
------------------------------	--	-----	----------

### Environmental Product Compliance

#### Compliance Search

Environmental Product Compliance 750-363/040-000 Fieldbus Coupler EtherNet/IP; 4th generation; Extreme		URL	Download
---	--	-----	----------

### Installation Notes

Subject to changes. Please also observe the further product documentation!



## Product family

### WAGO I/O System 750 XTR

I/O-System 750 XTR: Dort automatisieren, wo jedes andere System an seine Grenzen stößt – und das zuverlässig und wirtschaftlich! XTR – dieses Kürzel im Systemnamen steht für extremen Schutz vor klimatischen Einflüssen, Schwingungen, Erschütterungen und Überspannungen.

[Show all products from the family](#)

Subject to changes. Please also observe the further product documentation!

---

WAGO GmbH & Co. KG  
Hansastr. 27  
32423 Minden  
Phone: +49571 887-0 | Fax: +49571 887-169  
Email: [info.de@wago.com](mailto:info.de@wago.com) | Web: [www.wago.com](http://www.wago.com)

Do you have any questions about our products?  
We are always happy to take your call at +49 (571) 887-44222.