



**APPLIED PHYSICS
SYSTEMS**

MAGNETOMETER SENSOR

USER MANUAL

AP230



CONTACT US

HEADQUARTERS

425 Clyde Avenue
Mountain View, CA 94043

OFFICE

650.965.0500

FAX

650.965.0404

EMAIL

info@appliedphysics.com

APPLIEDPHYSICS.COM

AP230

DESCRIPTION

Since 1976, Applied Physics Systems has been supplying the oil and gas industries with accurate fluxgate magnetometers. Considering the popularity of fluxgate magnetometers in various industries, from satellites to submarines, Applied Physics Systems has introduced AP230 so that more industries and researchers can utilize accurate magnetometers. AP230 comes with a simplified command interface and free demo software to reduce the development time for our customers. AP230 is an all-in-one 3-axis fluxgate magnetometer with high accuracy (± 6.5 mG). Unlike other fluxgate magnetometers, AP230 does not require any external Data Acquisition Unit (DAQ) or analog circuitry. To help engineers and researchers with rapid development and testing, AP230 is fully compatible with the demo software provided by Applied Physics Systems. AP230 delivers up to 145 samples per second from all three axes placing it among the fastest fluxgate magnetometers. AP230 and fluxgate magnetometers, in general, do not experience hysteresis error as much as other types of magnetometers. As a result, they provide more accurate and reliable measurements.

AP230 has a measuring range of ± 0.65 G (± 65 μ T), slightly above the earth's total magnetic field in most places to provide the highest sensitivity possible. AP230 has a very low offset and noise level while offering exceptionally high linearity and temperature stability, making it suitable for a wide range of applications. AP230 supports a voltage range of 6VDC to 9VDC, and its specified operating temperature is 0°C to 70°C (for wider operating temperatures, please contact Applied Physics Systems).

FEATURES

- All in one 3-axis fluxgate magnetometer
- Plug and play with the free PC Software provided
- Internal DAQ (No external parts required)
- Up to 145 samples per second for all 3 axes
- RS-232 interface with user selectable baud rate (300, 1200, 2400, 4800, 9600, 19200, 38400)
- Durable metal enclosure
- Measurement Range: ± 0.65 G
- Operating Voltage: 7 VDC to 9 VDC
- Operating temperature: 0°C to 70°C
- Accuracy: $\pm 1\%$ of full-scale (6.5 mG)
- Noise Level: $3.0 \mu\text{G RMS}/\sqrt{\text{HZ}}$
- Offset: ± 2 mG
- Offset Drift: 50 $\mu\text{G}/^\circ\text{C}$
- Linearity: $\pm 0.1\%$ full-scale (± 650 μG)

APPLICATIONS

- Laboratory Instrumentation
- Compassing and Navigation
- Attitude Reference
- Anomaly Detection
- Material Testing



Figure 1 AP230 Magnetometer



Table of Contents

AP230.....	2
DESCRIPTION.....	2
FEATURES.....	2
APPLICATIONS.....	2
1. PACKAGE CONTENTS.....	4
2. QUICK START.....	5
3. SENSOR SPECIFICATIONS.....	8
4. AP230 MECHANICAL DRAWING.....	10
5. AP230 ELECTRICAL CONNECTION.....	11
6. AP230 COMMANDS.....	12
7. AP230 SOFTWARE FEATURES.....	16
7.1. COM CONFIGURATION.....	17
7.2. SENSOR'S REAL-TIME DATA.....	18
7.3. SENSOR AND SOFTWARE MEASUREMENTS IN GRAPH.....	19
7.4. SENSOR COMMUNICATION MONITOR.....	20
7.5. AZIMUTH AND MAGNETOMETER ROLL (MAG ROLL).....	21
8. EARTH MAGNETIC FIELD.....	22
8.1. EARTH'S MAGNETIC FIELD VARIATIONS.....	22
8.2. THE EARTH'S MAGNETIC FIELD IN APPLICATIONS.....	26
9. UNDERSTANDING SENSOR READINGS.....	27
10. MAGNETOMETER SENSOR INSTALLATION.....	28
11. CALIBRATION.....	29
ABOUT APPLIED PHYSICS.....	Error! Bookmark not defined.
COPYRIGHT.....	30
TRADEMARKS.....	30
CONTACT INFORMATION.....	30
DOCUMENT NUMBER.....	30
REVISION HISTORY.....	30

1. PACKAGE CONTENTS

Make sure you have all the following Items:



AP230 MAGNETOMETER

P/N: 150-1679

Quantity: 1



USB CABLE

P/N: 560-4536

Quantity: 1



INTERFACE CABLE

P/N: 151-18-0005

Quantity: 1



4-40 BRASS BOLT

P/N: 705-6094

Quantity: 4



CUSTOMER APPRECIATION DOCUMENT

Check under the red foam

Quantity: 1



CALIBRATION CERTIFICATE

Check under the red foam

Quantity: 1

2. QUICK START

- 1) Check the Package Contents, and verify you have all the components.
- 2) Scan the QR code to access the latest documentation.
The QR code on the sensor, or the customer appreciation document, will take you to the latest documentation. We strongly suggest that you use the latest documentation.
- 3) Download and install “Magnetometer Demo Software” to get a quick overview of the sensor's capabilities. Visit <https://www.appliedphysics.com/utilities/> and download the installer for our software. Once the download is complete, extract the file (the file is compressed), run the installer on a Windows-based computer, and install the application¹. After installation you do not have to run the application yet. See AP230 SOFTWARE FEATURES for further details.
- 4) Connect the interface box to your computer using the USB cable provided



Figure 2 Interface Box Connected to a Computer with USB Cable Provided

¹ If you were prompted with a Windows Defender warning, click on ‘More Info’ and then ‘Run Anyway’.

- 5) Connect AP230 to the interface box using the interface cable provided.



Figure 3 AP230 Connected to Interface Box with the Interface Cable Provided

- 6) Open the Magnetometer Demo Software. Select the COM port from the list and set the "Baud Rate" to 9600 (the default baud rate is 9600). Then click on Connect. If the 'no COM port' appeared, click on 'Refresh' after a few seconds.

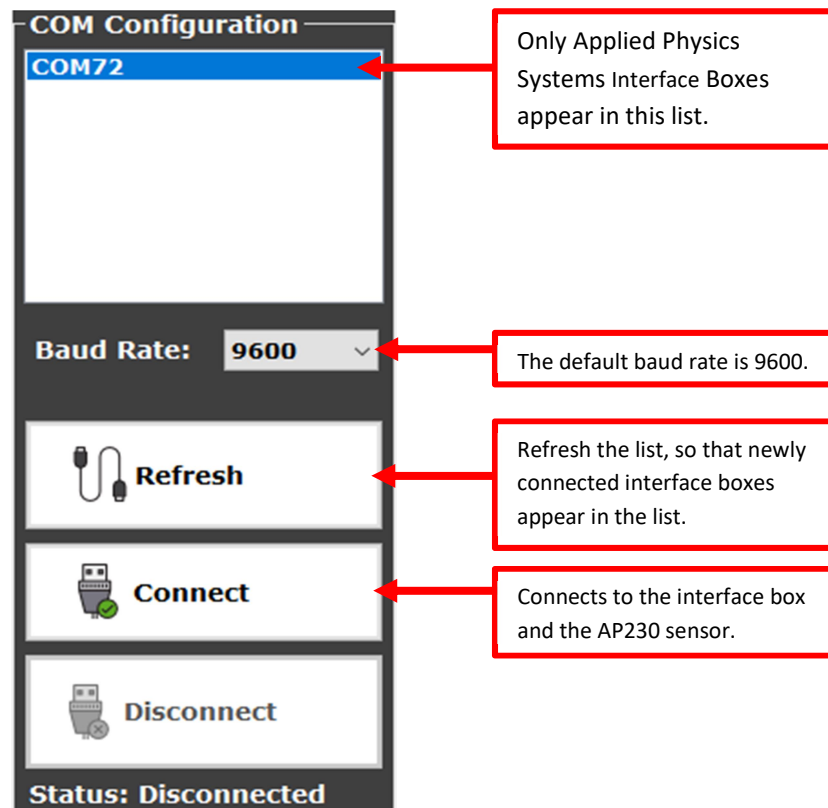

Figure 4 COM Configuration in Demo Software

7. Evaluate the Sensor Readings.

Check the raw data coming out of the sensor showing magnetic field in the X, Y, and Z-axis. 'Total Mag' indicates the total magnetic field measured by the sensor. The earth's magnetic field on its surface is between 0.25 G to 0.65 G, so the 'Total Mag' should be 0.25 G to 0.65 G (positive or negative). For evaluating the readings further, refer to UNDERSTANDING SENSOR READINGS section for more information.



Take note that the sensor should be far from magnetic objects (Iron, steel, etc. Check MAGNETOMETER SENSOR INSTALLATION for more Information) and electronic devices for Total Mag to be In the range of 0.25 to 0.65G.

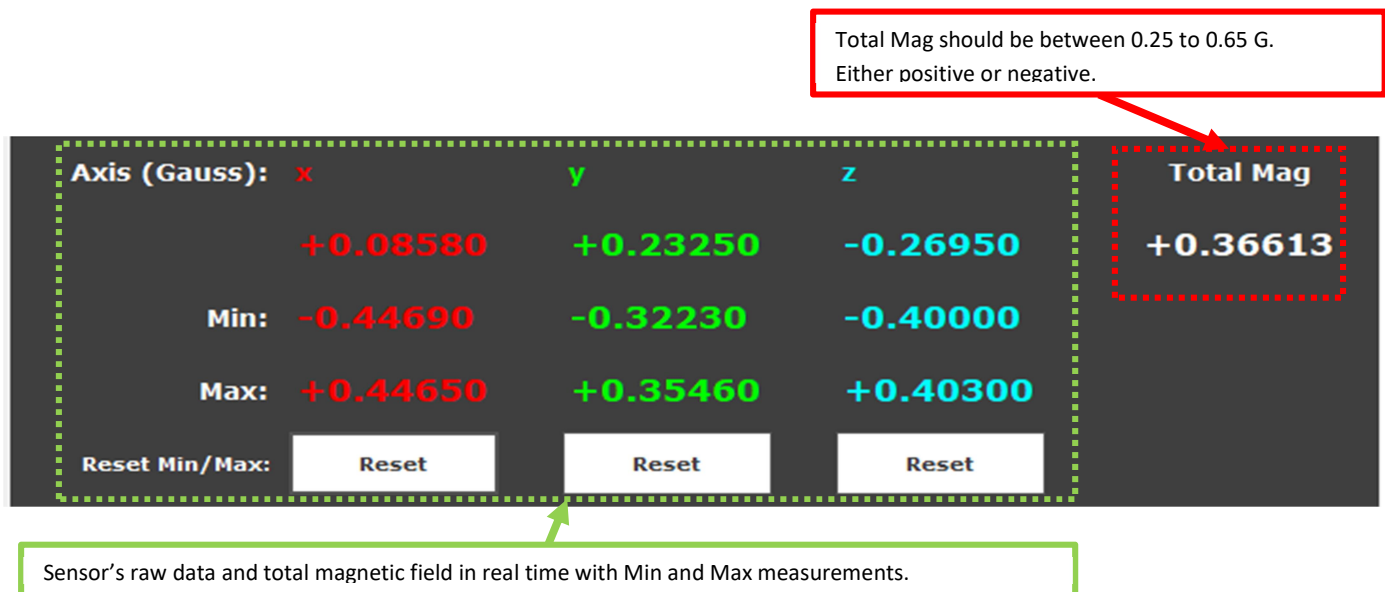

Figure 5 Sensor Readings in Demo Software

3. SENSOR SPECIFICATIONS

Specifications are subject to change without notice. All values are typical values measured at room temperature unless otherwise noted.

MECHANICAL	
Width	1.60" (40.64 mm)
Height	1.13" (28.70 mm)
Length	4.14" (105.16 mm)
Weight	150 grams
Connector on the Sensor	9-pin D-Sub Male/Plug Connector
Mating Connector	9-pin D-Sub Female/Receptacle Connector (Non-Magnetic)
ELECTRICAL	
Supply Voltage	+7 VDC to +9 VDC
Current Consumption	Under 90mA
Analog to Digital Converter	16-bit Sigma Delta
Baud Rate (User Selectable)	300, 1200, 2400, 4800, 9600, 19200, 38400
Default Baud Rate	9600
Maximum Output Sample Rate at 38400 Baud (in 'Auto-Send' mode)	145
ENVIRONMENTAL	
Operating Temperature Range	0°C to 70°C
PERFORMANCE AND ACCURACY	
Range	±65 mG (±65 μT)
Accuracy	±1% full-scale (±6.5 mG)
Offset Error (at 0mG)	±2 mG
Offset Drift versus Temperature	< 50 μG/°C
Linearity	±65 μG
Noise Level	3.0 μG RMS/\sqrt{HZ}
Orthogonality of Axes	Better than ±0.5°
Alignment of Axes with Package	Better than ±0.5°

Table 1 AP230 Sensor Specifications

*Table 2 Baud
Sample Rate*

BAUD RATE	OUTPUT SAMPLE RATE IN 'AUTO-SEND' MODE
300	1.2
1200	4.6

Rate and Output

2400	9.2
4800	18.5
9600	37
19200	73.9
38400	144.9

4. AP230 MECHANICAL DRAWING

The sensor's enclosure is made from Aluminum 6061-T6 and it is anodized in black.

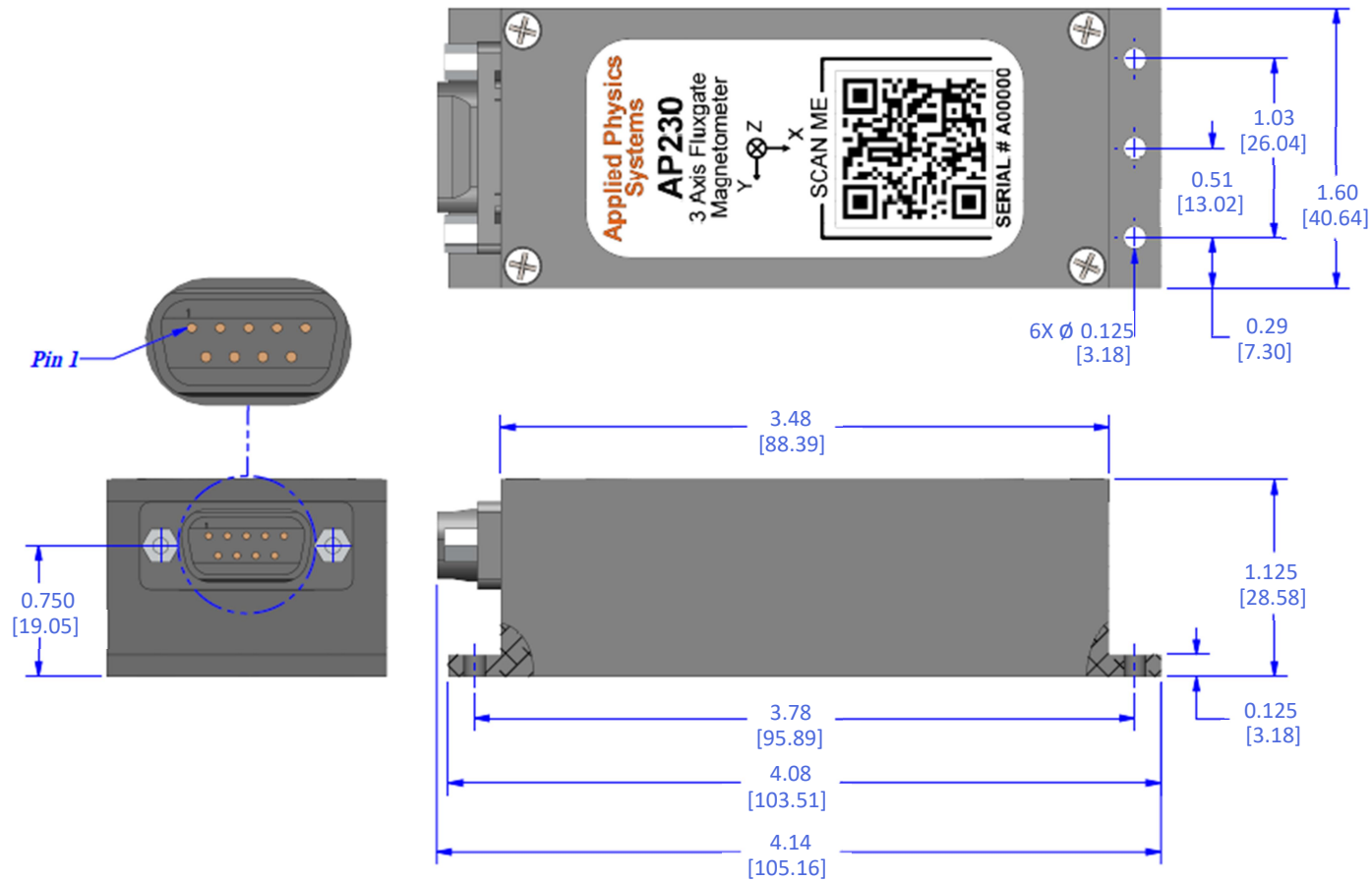

Figure 6 Mechanical Drawing

5. AP230 ELECTRICAL CONNECTION

A single input voltage powers the AP230 that can vary between +7 and +9 VDC. The sensor draws less than 90 mA from the supply for regular operation. AP230 utilizes RS-232 protocol to interface with other devices. The output baud rate is user programmable and can be set to the following values: 300, 1200, 2400, 4800, 9600, 19200, 38400. The data words employ 8 bits with one stop bit and no parity.

The interface cable (151-18-0005) comes with four non-magnetic brass bolts. If you want to secure the connector to the sensor, you must use these bolts or other non-magnetic bolts. It is crucial to use these non-magnetic bolts. A male 9-pin D-sub connector is on the AP230 sensor. The pinout of this connector is as follows:

Table 3 Connector Pinout

PIN	FUNCTION
1	Not used
2	RS-232 TXD
3	RS-232 RXD
4	Not used
5	Ground
6	Reserved – Must be Floating
7	Reserved – Must be Floating
8	Configure – Must be Floating
9	+V in (+7 VDC to +9 VDC)

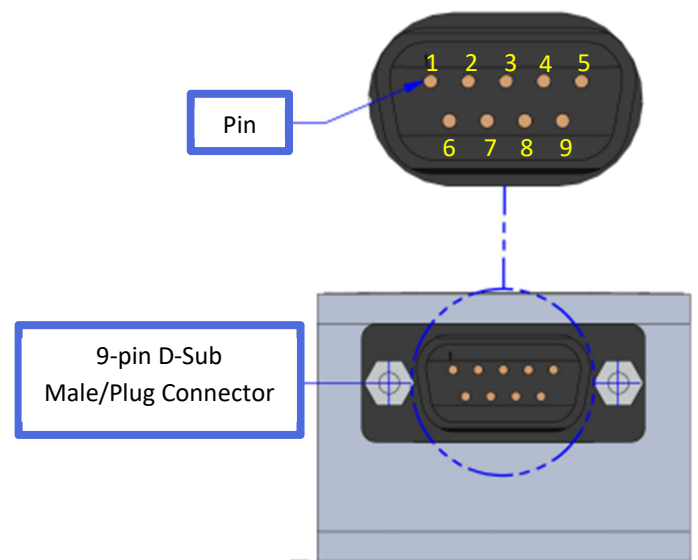

Figure 7 PIN 1 and 9-PIN D

You must obtain a non-magnetic connector if you decide to interface AP230 with other devices. Using widely available connectors can significantly impact the sensor's accuracy. The following list shows some of the non-magnetic connectors and parts that you may use with AP230.

Table 4 Connector compatibility

MANUFACTURER	MANUFACTURER DESCRIPTION	PART NUMBER
Harting	D-Sub 9pin female crimp shell - non-magnetic version	09670094701500
Molex	FCT NM ML DSUB CRP RCPT 09 PN	1731140219
Molex	FCT NM ML DSUB SDR RCPT 09 PN	1731140505
Molex	FCT HOOD S1 45 DEG MTL W/SCRWLCK NM (Non-magnetic backshell)	1731110470
Molex	FCT HOOD S1 0 DEG MTL W/SCRWLCK NM (Non-magnetic backshell)	1731140142

6. AP230 COMMANDS

AP230 has two operation modes, these modes are 'Stop' mode and 'Auto-Send' Mode. In 'Stop' mode the sensor can accept various commands (Table 5) and it can provide single readings. In 'Auto-Send' mode the sensor outputs readings as soon as possible (bounded by baud rate). Figure 8 AP230 States/Modes shows these two modes and the process to go from one more to another. If the sensor is in 'Stop' mode, sending character 'A' and carriage return over RS-232 would bring the sensor to 'Auto-Send' mode. From 'Auto-Send' mode a single character 'S' over RS-232 brings the sensor to the 'Stop' mode.

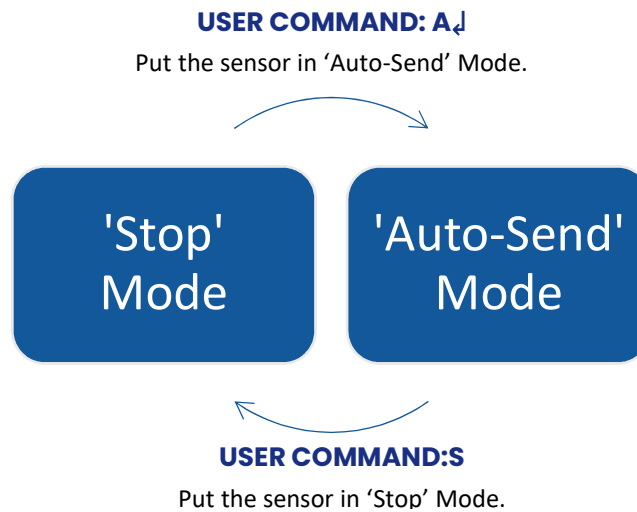

Figure 8 AP230 States/Modes

While Table 5 AP230 Commands shows the complete list of commands, in this section a high-level overview is provided. In this document ¶ and ↵ show Line Feed and Carriage Return, respectively. In this section and Table 5 AP230 Commands the **light blue text** represents sensor's output; and the **red text** represents user commands over RS-232.

- If you want to check a value, you must use a question mark '?'.
If you are going to set a value, you must use the equal sign '='.
- Carriage return (ASCII Code 0x0D) is needed at the end of all commands, except for the 'Stop' command.
- You can change the sensor's configuration only when the 'Stop' command has been sent or if the sensor is in 'Stop' mode. In 'Auto-Send' mode, the sensor ignores all commands except for the 'Stop' command.
- The sensor echoes back everything it receives when in 'Stop' mode. This feature allows you to confirm sensor's availability or baud rate mismatch.
- In 'Stop' mode, the sensor outputs the command's first letter before printing other associated messages (check the table below).

¶: Line Feed (ASCII 0x0A) → ' ': Space (ASCII 0x0A) → Command's first letter (ex. 'B') → ' ': Space (ASCII 0x0A)

- In 'Stop' mode, the sensor outputs the following after completing every command (except for the 'Restart' command):

'␣': Line Feed (ASCII 0X0A) → '␣': Carriage Return (ASCII 0x0D) → '␣': Line Feed (ASCII 0X0A) → '>': Close Angle Bracket (ASCII 0x3E)

- The commands are not case-sensitive.

Table 5 AP230 Commands

CMD	DESCRIPTION	SENSOR OUTPUT SENSOR OUTPUT IS SHOWN IN CYAN USER INPUT IS SHOWN IN RED
S	Put the Sensor in "Stop" Mode	
The following commands only work in "Stop" mode.		
?	Outputs a Simplified Version of this Table	A long list of commands.
A	<p>Puts the Sensor in the "Auto-Send" Mode</p> <p>In this mode, the sensor outputs data continuously and as fast as possible. The only limiting factor in this mode is the baud rate. For several output samples for a given baud rate, refer to Table 2 . To bring the sensor out of "Auto-Send" mode, put the sensor in "Stop" mode.</p> <p>"..." indicates many more readings as long as the sensor remains in "Auto-Send" mode.</p> <p>In AP230's output, the sign ('+' or '-') is included for each reading, and each reading has 4 decimal places (trailing zeros are included in the output), giving the sensor's output a fixed length.</p>	<p>␣>AA␣</p> <p>␣</p> <p>␣ A +0.1634 +0.3245 -0.4824 ␣</p> <p>␣+0.1634 +0.3244 -0.4825 ␣</p> <p>␣+0.1635 +0.3245 -0.4823 ␣</p> <p>␣+0.1630 +0.3245 -0.4825 ␣</p> <p>...</p>

D↵	<p>Outputs a Single Reading</p> <p>Unlike "Auto-Send" mode, this command outputs one reading. For the next reading, this command must be sent again. The Sensor Output column shows how 2 readings are extracted from the sensor using this command.</p> <p>In AP230's output, the sign ('+' or '-') is included for each reading, and each reading has 4 decimal places (trailing zeros are included in the output), giving the sensor's output a fixed length.</p>	<pre> >DD↵ ↵ D +0.1633 +0.3246 -0.4815 ↵ ↵ >DD↵ ↵ D +0.1630 +0.3246 -0.4812 ↵ ↵ > </pre>
B?↵	<p>Outputs its Current Baud Rate</p> <p>You must send the command in the matching Baud Rate for the sensor to respond correctly.</p>	<pre> >BB??↵ ↵ B Baud rate: 9600 BAUD↵ ↵ > </pre>
B=#↵	<p>Sets Baud Rate to #</p> <p>AP230's baud rate can be set to 300, 1200, 2400, 4800, 9600, 19200, or 38400. To set different baud rates, replace # with the desired baud rate. The sensor output is shown for "B=9600↵". Take note that once you send the command, the sensor changes the baud rate immediately.</p> <p><i>This part is in the old baud rate</i></p> <p><i>This part is in the new baud rate</i></p>	<pre> >BB==99660000↵ ↵ B ↵ ↵ > </pre>
M?↵	<p>Outputs its Current Output Format</p> <p>AP230 is designed to work in one output format. However, this command lets you check the output format to keep AP230 compatible with other Applied Physics magnetometers.</p>	<pre> >MM?? ↵ ↵ M The Sensor is Currently In: ↵ Corrected Data Mode↵ Not in Auto-Send Mode↵ Data sent by UART↵ Text mode↵ Decimal mode↵ Vector mode↵ Baud rate: 9600 BAUD↵ ↵ ↵ .> </pre>

M=C↵	Sets Output Format to Fixed-Point Values	<pre> >MM==CC↵ ↵ M Corrected Data Mode↵ ↵ .> </pre>
M=D↵	Sets Output Format to Decimals	<pre> >MM==DD↵ ↵ M Decimal Mode↵ ↵ > </pre>
M=V↵	Sets Output Format to Vector Form (X, Y, and Z)	<pre> >MM==VV↵ ↵ M Vector mode↵ ↵ > </pre>
M=CDV↵	Set Output Format to AP230's Default For a detailed description, check the following commands M=C↵ M=D↵ M=V↵ These settings result in AP230 output becoming formatted to always print the sign ('+' or '-') for each reading, and each reading has 4 decimal places (trailing zeros are included in the output). This results in the output being a fixed length. Sample outputs are shown in Sensor Output column.	<pre> >MM==CCDDVV↵ ↵ M Corrected Data Mode↵ Decimal mode↵ Vector mode↵ ↵ > </pre> <p>Sample outputs</p> <pre> +0.1635 +0.3245 -0.4823 ↵ +0.1630 +0.3245 -0.4825 ↵ </pre>
*↵	Restarts the Sensor	<pre> .>**↵ ↵ * ↵ > </pre>

7. AP230 SOFTWARE FEATURES

The software is made of 5 sections, each section focusing on a specific task:

- COM Configuration
- Sensor's Real-Time Data
- Sensor and Software Measurements in Graph
- Sensor Communication Monitor
- Azimuth and Magnetometer Roll

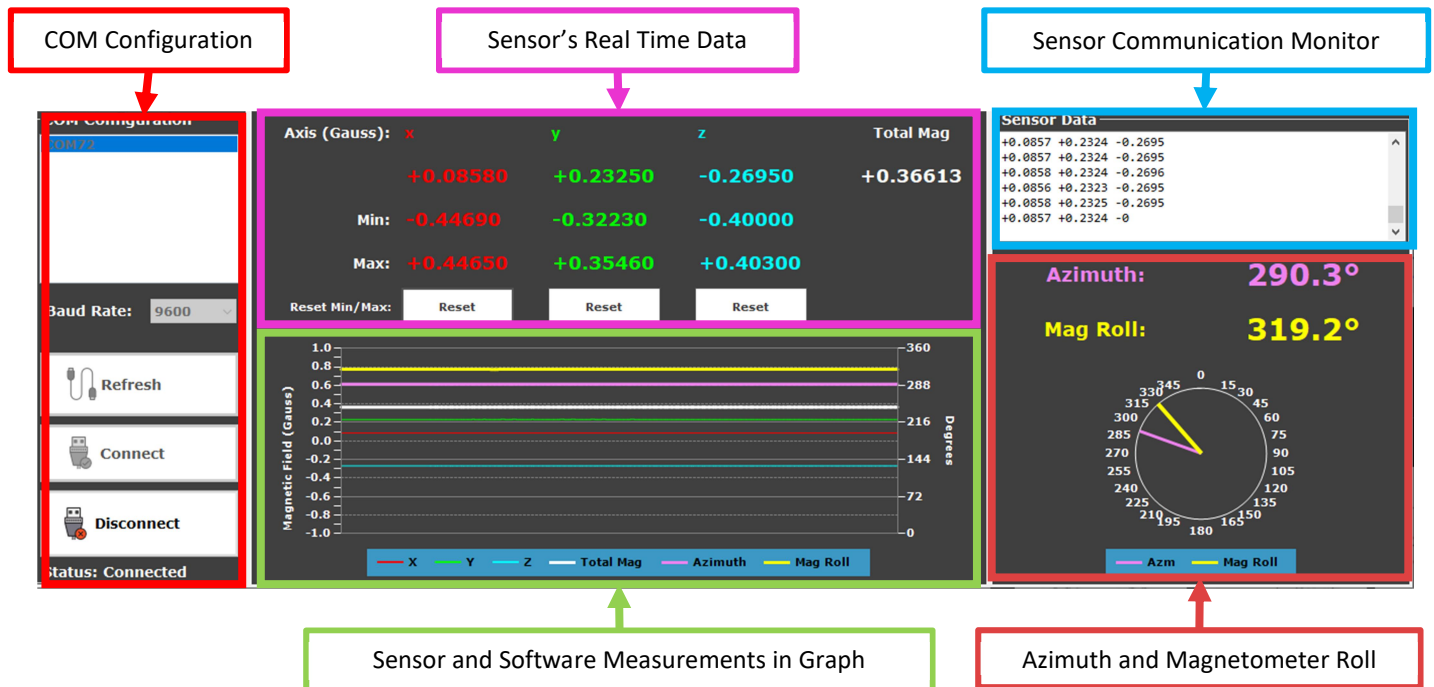
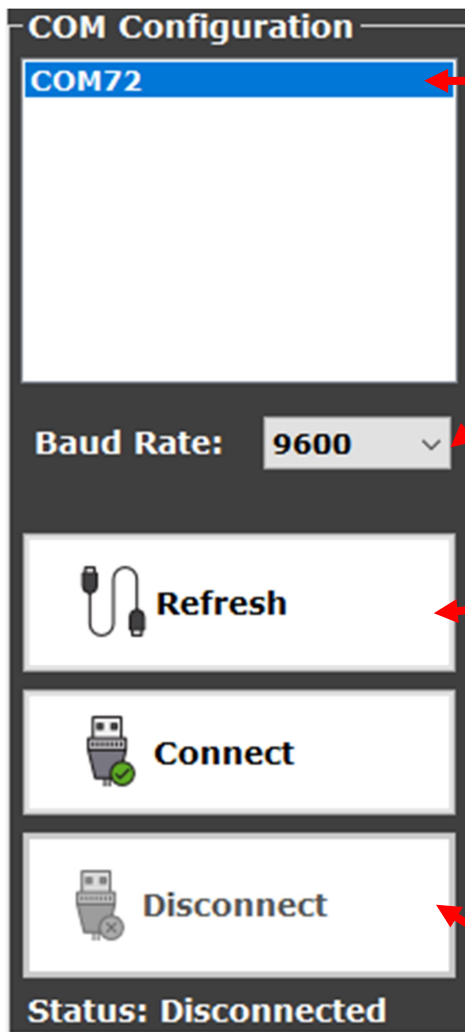

Figure 9 Demo Software and its Five Sections

7.1. COM CONFIGURATION

In this section, you can specify the COM port and the baud rate of your interest. Take note that **only** Applied Physics interface box COM ports are listed.

The baud rates are limited to AP230 baud rates which are: 300, 1200, 2400, 4800, 9600, 19200, and 38400.



Please select the COM port of your interest. Take note only Applied Physics Systems Interface Boxes appear in this list.

You may select 300, 1200, 2400, 4800, 9600, 19200, 38400 as the RS-232 baud rate, however you must make sure the sensor is set to operate in the same baud rate. The default baud rate 9600. Check the AP230 COMMANDS section for more information on changing the sensor's baud rate.

"Refresh" button refreshes the list, so that newly connected interface boxes appear in the list. It may take up to several seconds for a newly connected device to appear in the list.

"Disconnect" button disconnects the Demo Software from the AP230 sensor connected to the selected COM port. After disconnecting the COM port can be used by other software.

It shows the status of the COM port.

7.2. SENSOR'S REAL-TIME DATA

This part of the software shows the latest sensor reading and the min and max values for each axis. "Total Mag" shows the total magnetic flux density, computed based on measurements along each axis. You may use the "Reset" Button to reset the min and max values

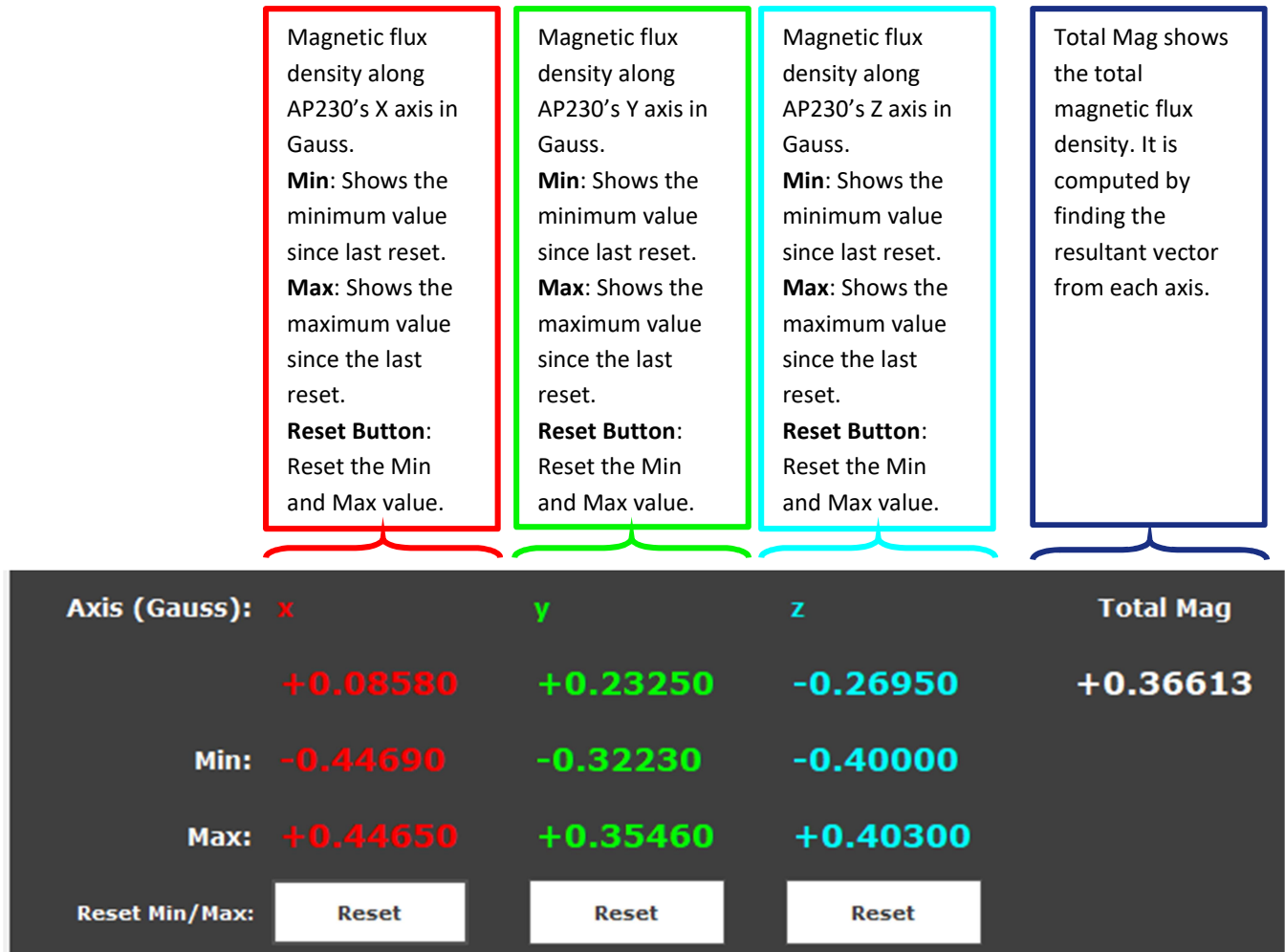

Figure 10 Real-Time Sensor Data in Demo Software

7.3. SENSOR AND SOFTWARE MEASUREMENTS IN GRAPH

In this section of the Demo software, all readings and computed values are graphed versus time. X, Y, Z, and Total Mag are measured in Gauss, while Azimuth and Mag Roll are measured in degree. The graphs allow you to visualize the reading over time.

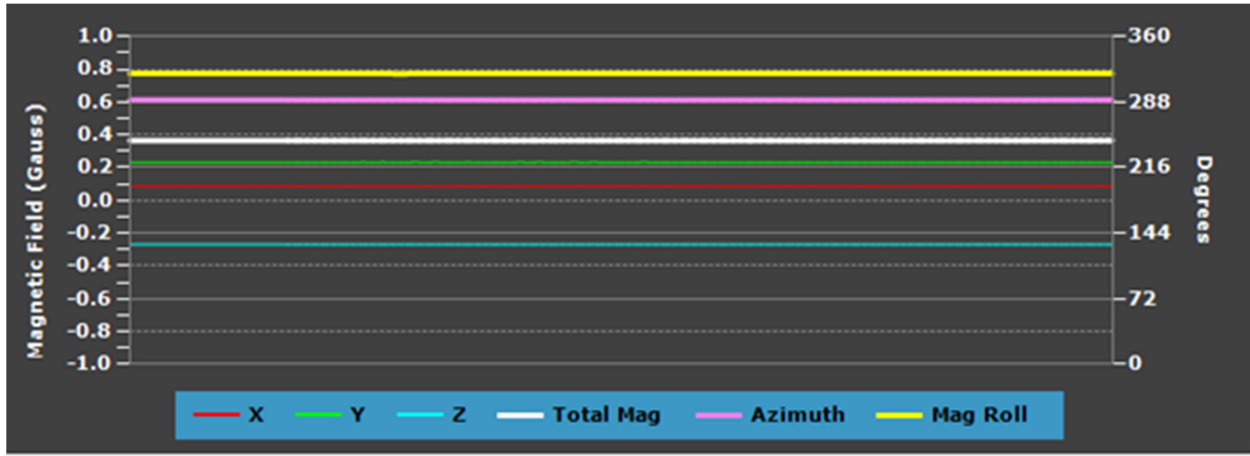
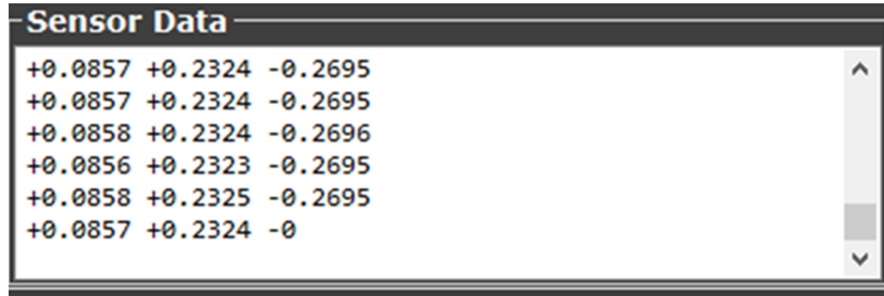

Figure 11 Sensor and Software Measurements as a Graph in Demo Software

7.4. SENSOR COMMUNICATION MONITOR

This section shows all the receiving data from the sensor in the format sent to the Demo Software. This helps users to monitor all the receiving data through RS-232. This section would be especially handy if you plan to develop a library to parse the data on different platforms.



Sensor Data		
+0.0857	+0.2324	-0.2695
+0.0857	+0.2324	-0.2695
+0.0858	+0.2324	-0.2696
+0.0856	+0.2323	-0.2695
+0.0858	+0.2325	-0.2695
+0.0857	+0.2324	-0

Figure 12 Sensor Communication Monitor in Demo Software

7.5. AZIMUTH AND MAGNETOMETER ROLL (MAG ROLL)

Azimuth and magnetometer roll ("Mag Roll") are calculated within Demo Software using the readings from X, Y, and Z axis.

While AP230 does not compute Azimuth and Mag Roll internally, Applied Physics Systems offers other sensors that compute Azimuth and Mag Roll internally. Please contact Applied Physics Systems for more information.

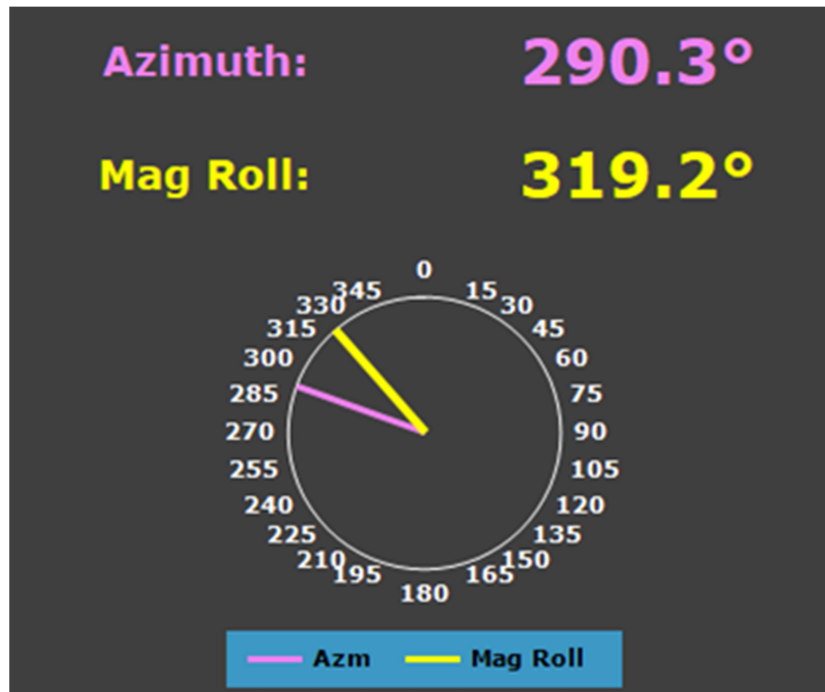

Figure 13 Azimuth and Mag Roll in Demo Software

8. EARTH MAGNETIC FIELD

A self-exciting dynamo process generated the earth's magnetic field in the fluid outer core. The electrical currents' flow in the gradual motion of the molten iron generates the magnetic field. Besides the sources in the earth's core, the observable magnetic field on its surface has sources in the crust, ionosphere, and magnetosphere.

The earth's magnetic field varies in a scale range overtime, in the following sections these variations are presented.

8.1. EARTH'S MAGNETIC FIELD VARIATIONS

8.1.1. REVERSALS

During rock formation, it acquires magnetization parallel to the core generation field. The axial pole's polarity has changed over the decades². Each polarity interval lasts several hundred decades. The reversals occurred at a gradual and irregular pace for 30 million years and were absent about 100 years before the present times.

Besides full reversals, aborted reversals have occurred – when the magnetic poles move towards the equator (for a while) but return and align close to the earth's spin axis.

Reversal inhibition occurs through the solid inner metalcore, with a 6 percent current decline in the dipole moment per century.

8.1.2. CURRENT MAGNETIC FIELD

The present magnetic field: The main field is approximately derived through a dipole located at the earth's center and tilted to the axis of rotation by 10°. Despite the placement, significant deviations from a dipole field may exist.

The following figures reflect maps of declination, inclination, horizontal intensity, vertical intensity, and total intensity at 2020.0, derived from the 13th Generation IGRF model.

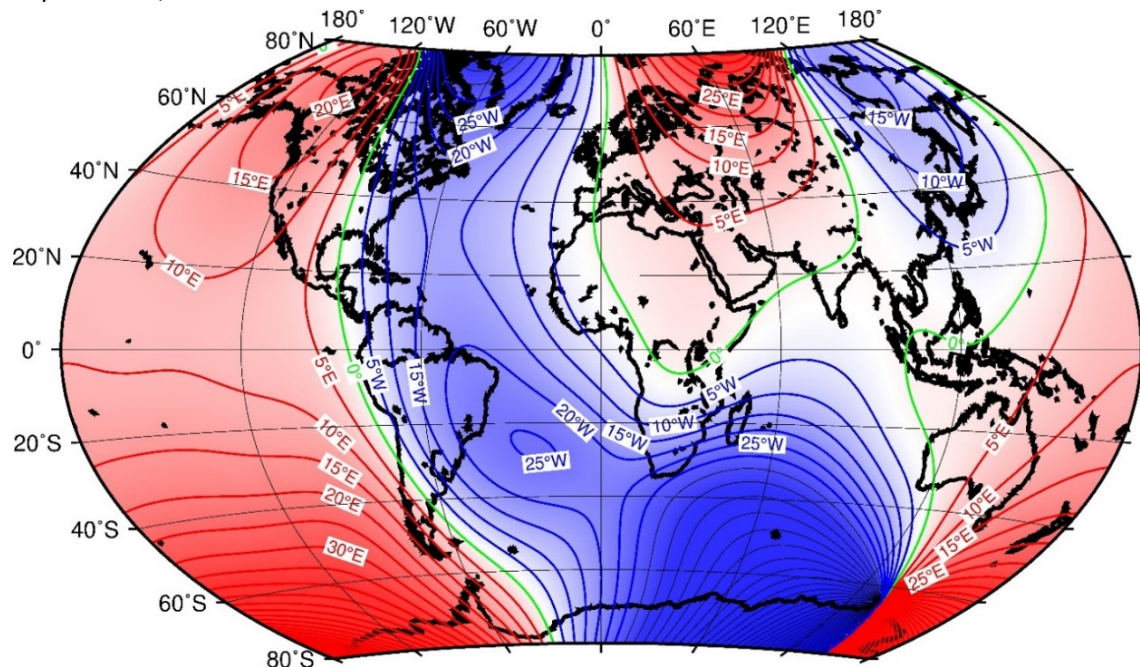

Figure 14 Map of Declination (Degrees East or West of True North) at 2020.0³

² In-depth rock-magnetization directional and intensity research over the decades (from numerous global sites)

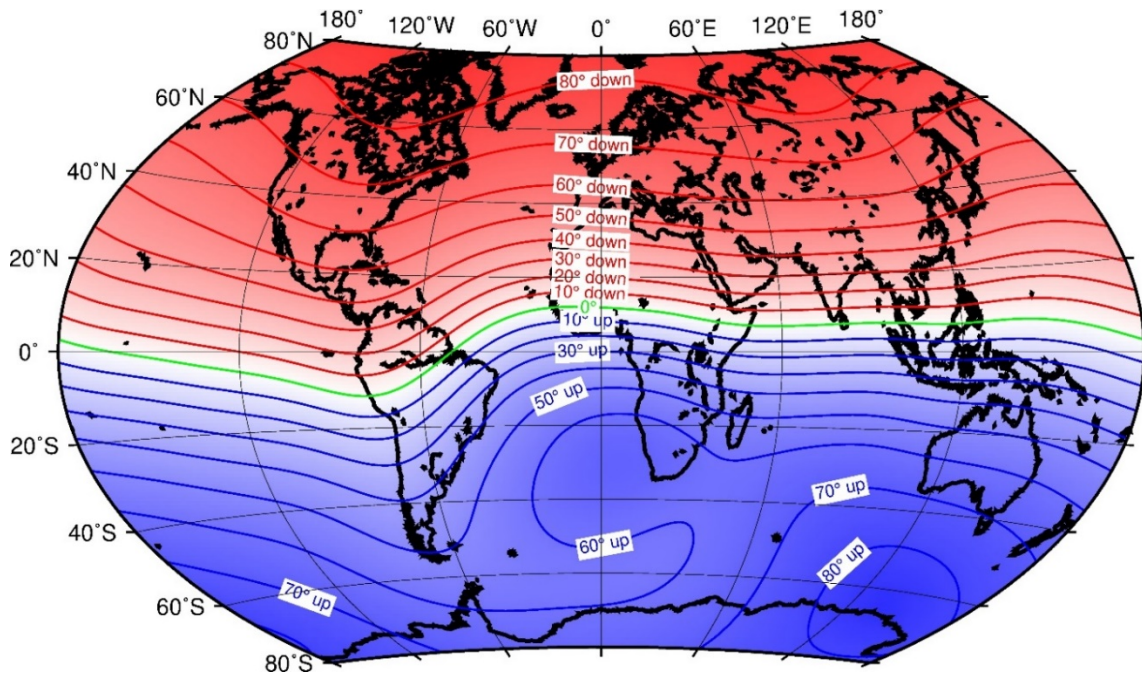

Figure 15 Map of Inclination (Angle in Degrees Up or Down that Magnetic Field Vector is from the Horizontal) at 2020.0⁴

³ <http://www.geomag.bgs.ac.uk/education/earthmag.html>

⁴ <http://www.geomag.bgs.ac.uk/education/earthmag.html>

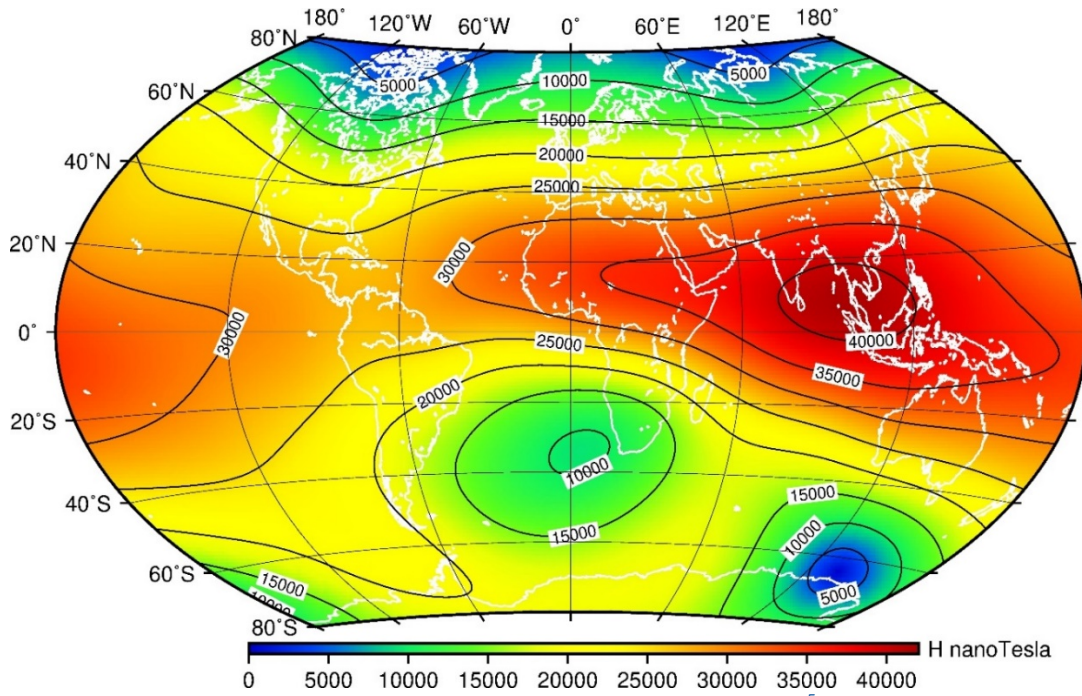

Figure 16 Map of Horizontal Intensity at 2020.0⁵

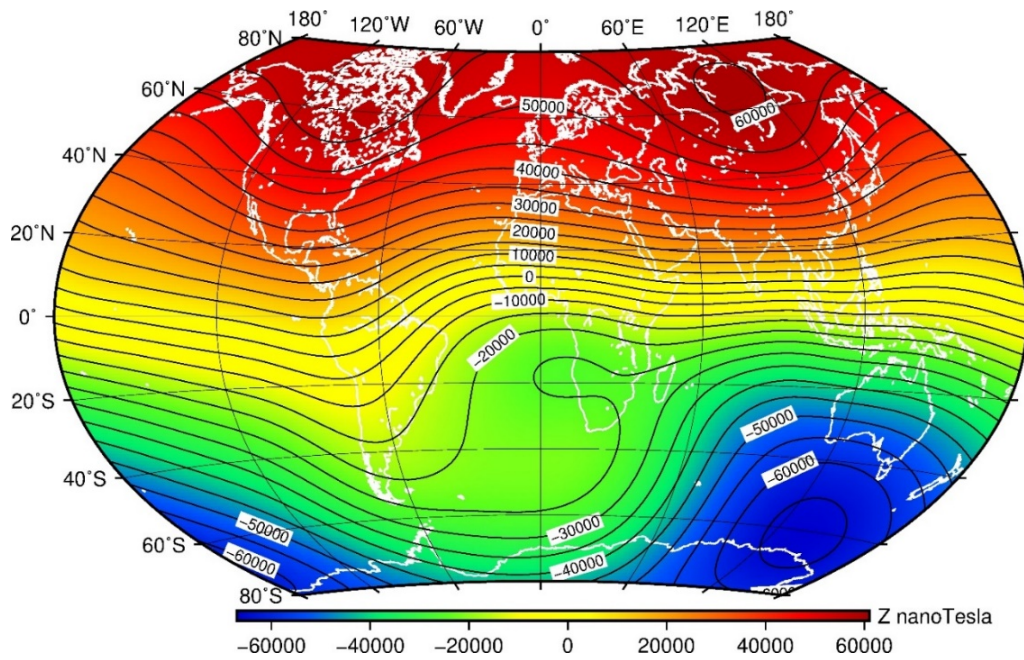

Figure 17 Map of Vertical Intensity at 2020.0⁶

⁵ <http://www.geomag.bgs.ac.uk/education/earthmag.html>

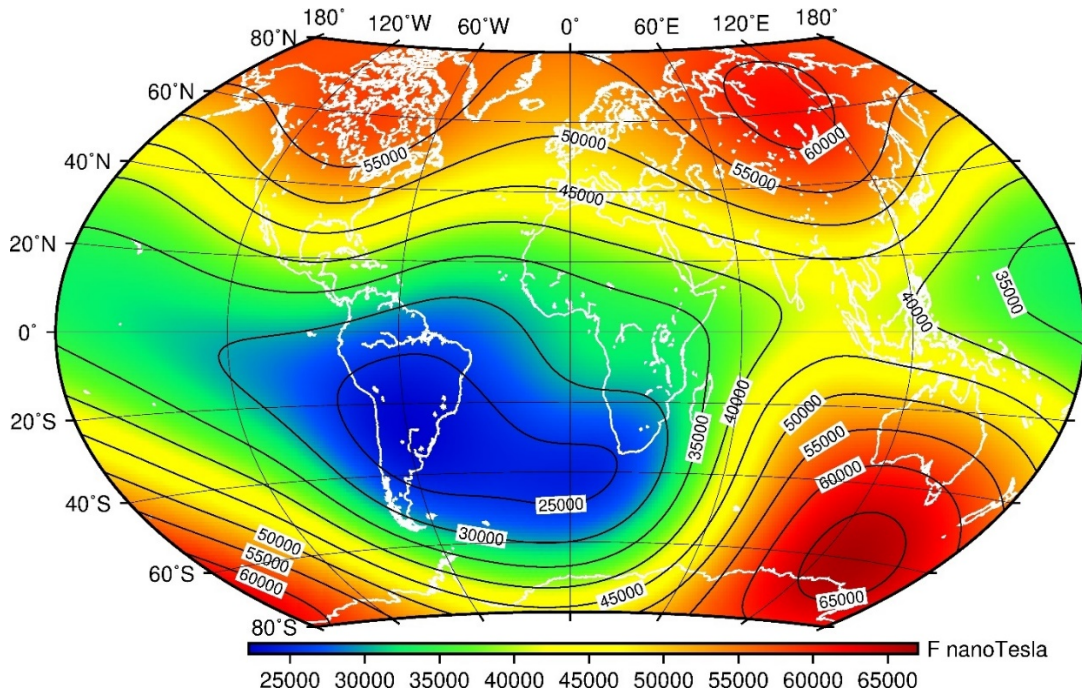

Figure 18 Map of Total Intensity at 2020.0⁷

8.1.3. WESTWARD DRIFT

Researchers note that the declination pattern at the earth's surface seems to move slowly westwards (direct magnetic field observations over four decades). Mainly apparent in the Atlantic Hemisphere at mid-and equatorial latitudes. It is related to the westward fluid motion at the core that drags the magnetic field.

8.1.4. GEOMAGNETIC JERKS

There have been numerous changes in the general trend of secular variations, particularly in 1925, 1969, 1978, and 1992. These sudden changes, known as jerks or impulses, are not researched into and are unpredictable.

8.1.5. CRUSTAL MAGNETIC FIELD

The anomaly field arising from the magnetic materials in the earth's crust varies on all spatial scales. Its knowledge is considered valuable for geographical exploration tools. The mid-ocean anomalies are fascinating as molten mantle reaches the surface and solidifies to form a new oceanic crust. The strength and direction of the modern ambient magnetic field are preserved in it.

8.1.6. FIELD VARIATIONS AT QUIET TIMES

The geomagnetic field possesses a regular slight variation with a fundamental 24-hours period. It is easiest to observe during minimum solar activity when varied disturbances occur less frequently. Despite the small size of the effect, those who measure the earth's magnetic field for precise navigation find it particularly interesting.

8.1.7. FIELD VARIATIONS AT DISTURBED TIMES

⁶ <http://www.geomag.bgs.ac.uk/education/earthmag.html>

⁷ <http://www.geomag.bgs.ac.uk/education/earthmag.html>

In addition, the daily variations display irregular disturbances as well. At a larger scale, they are referred to as magnetic storms. These disturbances are caused by solar wind interaction. Disturbance in the solar wind, the current systems exist within the magnetosphere enhance and cause magnetic storms.

8.2. THE EARTH'S MAGNETIC FIELD IN APPLICATIONS

Modern declination values, or differences between grid and magnetic north, reflect on various charts and maps such as the contemporary sea charts, topographical maps, and aeronautical charts. The values are updated with regular model revisions of their source. This is a crucial example of the earth's magnetic field functioning as a tool. Further, the earth's magnetic field serves as a tool with directional drilling, geomagnetically induced currents, satellite operations, exploration geophysics (can be easily considered a hazard at high altitudes if there is failure to remove daily variations and magnetic storm effects before interpretation.)

9. UNDERSTANDING SENSOR READINGS

9.1. PER AXIS READINGS AND TOTAL MAG

The sensor measures magnetic flux intensity in the X, Y, and Z-axis. The axes are shown below with respect to the sensor's enclosure and in matching color as seen in Magnetometer Demo Software. The label on the sensor shows the orientation of the vector as well.

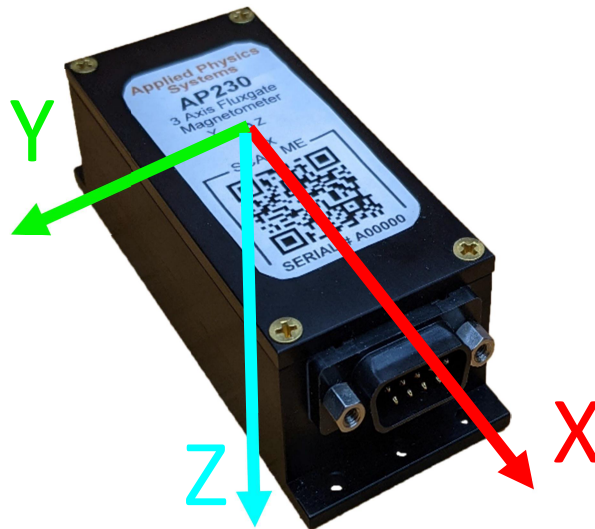

Figure 19 Vector Orientation

To verify the sensor's reading, locate yourself on the map in Figure 18 and find out the total intensity in your region. The unit in the figure is Nano Tesla (nT) while the Demo Software measure in Gauss (G). 1 nT is equal to 10 μ G, so divide the numbers in the figure by 100,000 to get their equivalent value in Gauss. For example, 45000 nT in the figure is 0.45 G in the Demo Software.

Once you have checked the total intensity, you may check the Z-axis reading and compare it with vertical intensity in

Figure 17.



If you are planning to compare sensor readings with the values shown in **Error! Reference source not found.**, then take note that the sensor must be far from magnetic objects (iron, steel, etc., check MAGNETOMETER SENSOR INSTALLATION section for more information) and

10. MAGNETOMETER SENSOR INSTALLATION

You can categorize metals into two categories, ferrous and non-ferrous. Metals like aluminum, copper, or brass do not shield magnetic fields, although currents flowing through them may induce local magnetic fields. Ferrous metals like steel, nickel, and iron will distort magnetic fields by attracting them compared to passing through the surrounding air. When using the earth's magnetic field for compassing, ensure the sensors have sufficient distance from ferrous objects that could bend the fields and cause a heading error. This occurs with any type of magnetic sensor. The amount of distance depends on the size and proximity of the ferrous object.

AP230 has 3 mounting holes on each side, it is crucial to use nonmagnetic bolts when mounting the sensor. Failure to use nonmagnetic bolts can negatively impact the sensor's accuracy.



For securing or mounting the sensor, make sure all parts are made of non-ferrous metals (copper, brass, or aluminum (under normal circumstances)).

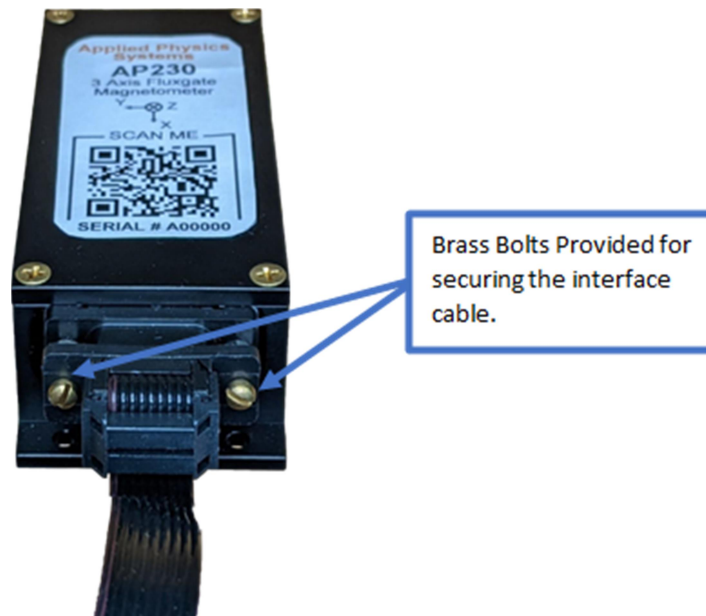

Figure 20 Mounting Sensors and Brass Bolts

It is critical to use non-magnetic connectors because other connectors may negatively affect the sensor's accuracy. In Table 4 the list of non-magnetic connectors is available. If you decide to use the interface cable (151-18-0005), ensure you secure the connector with the brass 4-40 bolts provided. Failure to use non-magnetic bolts can impact the sensor's accuracy negatively.

11. CALIBRATION

Every AP230 sensor has a unique serial number. This serial number is printed on the packing, on the sensor, and the Calibration Certificate. This unique serial number allows Applied Physics Systems to track each sensor through their lifetime, and over the years, this has helped us serve our customers better.

sad



Figure 21 Unique Serial Numbers Displayed on Interface Box, AP230 Device, and Certificate

AP230 is an accurate sensor, and to maintain the same level of accuracy, Applied Physics recommends annual calibration AP230. To help our customers with calibration date tracking, we issue and include a calibration certificate in all sold packages. To request calibration, please visit <https://www.appliedphysics.com/support/#rma> and fill a calibration request. In the 'Reason for Return' field, write 'calibration' and provide all the information based on your circumstances.

COPYRIGHT

All Rights Reserved.

The contents of this manual may not be reprinted in part or whole without permission.

The contents of this manual are subject to change without notice.

TRADEMARKS

All other brands or products mentioned are trademarks or registered trademarks of their respective holders and should be treated as such.

CONTACT INFORMATION

Applied Physics Systems
Corporate Headquarters
425 Clyde Avenue
Mountain View, California 94043
USA
Phone: 650.965.0500
Fax: 650.965.0404
Email: service@appliedphysics.com
Web: www.appliedphysics.com
Technical Support Hours:
Monday - Friday
9:00 AM - 5:00 PM
Pacific Standard Time

DOCUMENT NUMBER

260-0601 Rev. A

REVISION HISTORY

REVISION	DESCRIPTION	DATE
A	Initial Released	August 2021