

DATASHEET

Multi-Channel Superluminescent Diode Source

Optical Spectral Engine (OSE2)

**32 Pin-Butterfly Package, 5 SLEDs: 1300nm, 1340nm, 1390nm, 1430nm, 1480nm,
SM Fiber, High Degree of Polarization, Spectral Coverage: 1265nm-1500nm,
FWHM: 235nm, CW: 1383nm, Light Output Power >35mW**

Luxmux Part Number: ASM000106

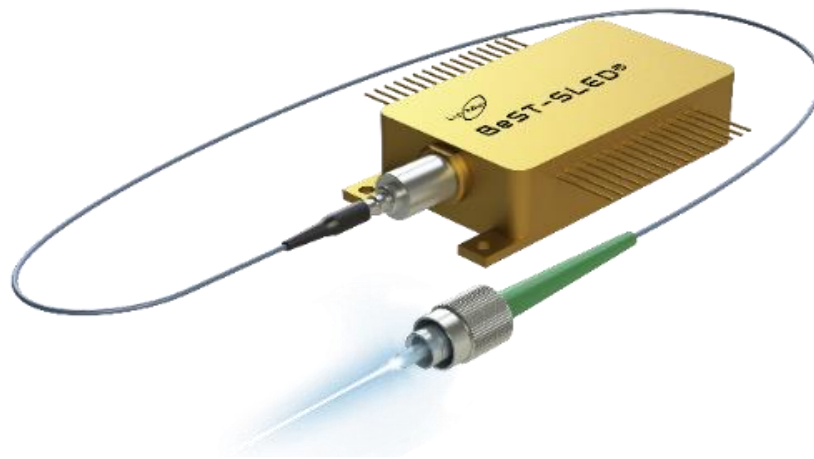

A. PRODUCT DESCRIPTION

The Optical Spectral Engine (OSE2) ASM000106 is a broadband superluminescent diode (SLED) light source that operates within the near-infrared (NIR) region. It is a compact 32-pin butterfly package that provides an integrated optical interface and one of the highest power-density within the SLED technology industry.

This SLED offers spectral coverage from 1265nm to 1500nm, with up to 35mW of optical power. The temperature of the device is regulated by an integrated thermoelectric cooler (TEC). This light source is compact and easy to use, making it an appropriate fit for many different types of manufactured assemblies requiring light power, including the applications below:

B. KEY FEATURES

- Five superluminescent diodes (SLEDs)
- All SLEDs can be run from 0 – 100% of maximum rating
- Output power: >35mW
- Bandwidth FWHM: 235nm
- Light output: FC/APC Connector (Optional FC/PC or SMA)
- Luxmux’s patented technology for spectral stitching provides optimum power and bandwidth
- Each SLED comes with a built-in independent monitor photodiode and one common thermoelectric cooler (TEC) for all SLEDs

C. APPLICATIONS

- Optical Component Testing
- Telecom Test Equipment
- Medical Optical Coherence Tomography
- Industrial Optical Coherence Tomography
- Metrology
- Biomedical Imaging Systems
- Optical Sensing
- White Light Interferometry & Chromatic Dispersion
- Research and Development

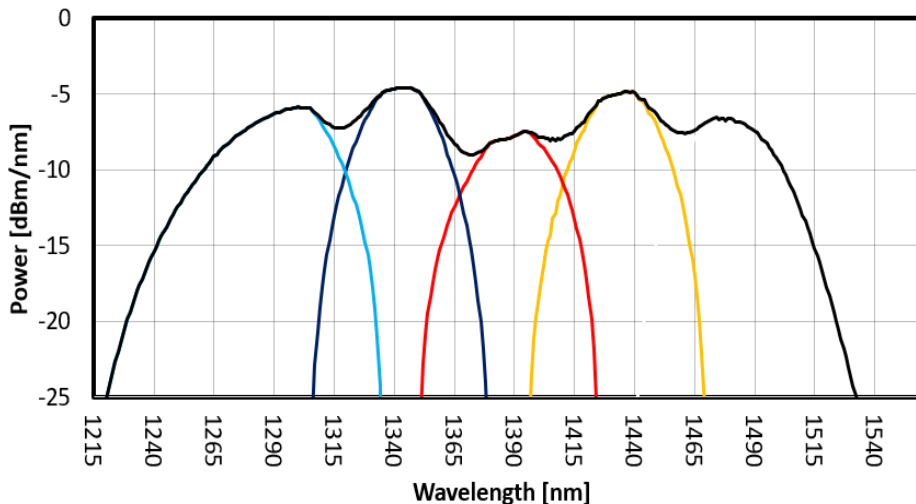



D. ABSOLUTE MAXIMUM RATINGS (see note 1)

Parameter	Symbol	Condition	Min.	Max.	Unit
Reverse Voltage (All SLEDs)	V_R	CW	-	2	V
Operating Current SLED 1 – 1480nm SLED 2 – 1430nm SLED 3 – 1390nm SLED 4 – 1340nm SLED 5 – 1300nm	I_{OP}	CW $T_{OP} = 25^{\circ}\text{C}$ $T_{TEC} = 21^{\circ}\text{C}$	-	400 400 450 400 550	mA
Forward Voltage SLED 1 – 1480nm SLED 2 – 1430nm SLED 3 – 1390nm SLED 4 – 1340nm SLED 5 – 1300nm	V_F	CW $T_{OP} = 25^{\circ}\text{C}$ $T_{TEC} = 21^{\circ}\text{C}$	-	2.5 2.5 2.5 2.5 2.8	V
OSE2 Package Temperature (see note 2)	T_{OSE2}		-40	80	$^{\circ}\text{C}$
SLED Operating Temperature (see note 3)	T_{SLED}	I_{OP}	0	70	$^{\circ}\text{C}$
TEC Current	I_{TEC}		-	10	A
TEC Voltage	V_{TEC}		-	9	V
TEC Temperature	T_{TEC}		0	50	$^{\circ}\text{C}$
Storage Temperature (see note 4)	T_{stg}	No condensation, Unbiased	-40	85	$^{\circ}\text{C}$
Storage Humidity (see note 4)	RH_{stg}		5	85	%RH
Electro Static Discharge (ESD)	V_{ESD}	Human Body Model	-	500	V
Lead soldering temperature	T_{Solder}		-	280	$^{\circ}\text{C}$
Lead soldering time	t_{Solder}		-	10	s

Notes:

1. Please note that exceeding the Absolute Maximum Ratings above may cause device failure. Luxmux does not bear responsibility for laser power damage that is attributed to electrostatic discharge, excessive current levels, and current spikes (transients).

Any attempts to increase the laser drive current above the pre-set limits or recommended specification limits, can damage the device, and nullify the warranty period. It should be emphasized that the current limit set points cannot be exceeded.
2. For optimum performance of the Optical Spectral Engine (OSE2), the OSE2 must be operated within the specified temperature ranges. The BeST-SLED has an internal thermoelectric cooler (TEC) but it's always required to mount the OSE2 on an appropriate heatsink, capable of dissipating up to 15W.
3. T_{TEC} is monitored by internal thermistor with external readout.
4. Storage temperature and relative humidity should be chosen so the dew point of the humid air around the package is below the storage temperature of the package, to avoid condensation on the package.



Redefining Spectral Boundaries

E. OPTICAL AND ELECTRICAL SPECIFICATIONS (see note 5)

Parameter	Symbol	Condition	Min.	Typ.	Max.	Unit
Center wavelength (see note 6)						
SLED 1 – 1480nm	CWL	CW T _{OP} = 25°C T _{TEC} = 21°C	1470	1480	1490	nm
SLED 2 – 1430nm			1420	1430	1440	
SLED 3 – 1390nm			1380	1390	1400	
SLED 4 – 1340nm			1330	1340	1350	
SLED 5 – 1300nm			1290	1300	1310	
SLED 1+2+3+4+5 – 1580nm			1373	1383	1393	
Operating Current						
SLED 1 – 1480nm	I _{OP}	CW T _{OSE2} = 25°C T _{TEC} = 21°C			350	mA
SLED 2 – 1430nm					350	
SLED 3 – 1390nm					400	
SLED 4 – 1340nm					350	
SLED 5 – 1300nm					500	
Forward Voltage						
SLED 1 – 1480nm	V _F	CW T _{OSE2} = 25°C T _{TEC} = 21°C			2.0	V
SLED 2 – 1430nm					2.0	
SLED 3 – 1390nm					2.0	
SLED 4 – 1340nm					2.0	
SLED 5 – 1300nm					2.0	
SM Fiber Coupled Power						
SLED 1 – 1480nm	P	CW T _{OP} = 25°C T _{TEC} = 21°C I _{OP}		6		mW
SLED 2 – 1430nm				7		
SLED 3 – 1390nm				5		
SLED 4 – 1340nm				8		
SLED 5 – 1300nm				9		
SLED 1+2+3+4+5 – 1580nm				35		
Bandwidth FWHM (see note 7)						
SLED 1 – 1480nm	B _{FWHM}	CW T _{OP} = 25°C T _{TEC} = 21°C I _{OP}		40		nm
SLED 2 – 1430nm				35		
SLED 3 – 1390nm				40		
SLED 4 – 1340nm				35		
SLED 5 – 1300nm				50		
SLED 1+2+3+4+5 – 1580nm				235		
Bandwidth @-10dB						
SLED 1 – 1480nm	B _{@10dB}	CW T _{OP} = 25°C T _{TEC} = 21°C I _{OP}		70		nm
SLED 2 – 1430nm				60		
SLED 3 – 1390nm				65		
SLED 4 – 1340nm				60		
SLED 5 – 1300nm				85		
SLED 1+2+3+4 – 1580nm				280		
Spectral Coverage	SC	CW T _{OP} = 25°C T _{TEC} = 21°C I _{OP}	-	1265-1500	-	nm

Spectrum Ripple (see note 8) SLED 1 – 1480nm SLED 2 – 1430nm SLED 3 – 1390nm SLED 4 – 1340nm SLED 5 – 1300nm	R	CW $T_{OP} = 25^{\circ}C$ $T_{TEC} = 21^{\circ}C$	< 0.15	< 0.30	0.45 0.6 0.35 0.4 0.45	dB
Polarization Extinction Ratio (see note 9)	PER	CW $T_{OP} = 25^{\circ}C$ $T_{TEC} = 21^{\circ}C$ I_{OP}	10	-	-	dB
RIN	RIN		-	< -130	-	dB/Hz
Thermistor Resistance TEC	R_{THTEC}	$T_{OP} = 25^{\circ}C$ $T_{TEC} = 21^{\circ}C$	9.5	10.0	10.5	k Ω
Power Dissipation (see note 10)	P_{DISS}	I_{OP}	-	12	-	W
TEC Voltage	V_{TEC}		-	-	9	V
TEC Current	I_{TEC}		-	-	10	A

Notes:

- There may be differences in typical values of output power, power stability, wavelength and bandwidth, due to coupling efficiency. These values are references and there is no guarantee that each particular OSE2 module will have EXACTLY the typical values shown on the previous chart. The specification lists the operating temperature for the electrical/optical characteristics, which is the temperature of the OSE2 during the time that the specifications were measured. Variation in temperature beyond what is specified can have a significant effect on the optical characteristics, like changes in wavelength or drop in output power.
- Center Wavelength is defined as the center point of the 3dB bandwidth of each individual SLED.
- BeST-SLED FWHM is defined as the bandwidth from the lowest spectral dip, when all the SLEDs are on.
- Resolution of 0.1nm. Figure of merit does not include dips between SLEDs.
- Polarization Extinction Ratio is defined as the ratio of optical powers of perpendicular polarizations, expressed in decibels (dB).
- Power dissipation when all SLEDs are on and $|T_{OSE2} - T_{TEC}|$ is 40°C.

F. PLOTS - Test performed at $T_{OP}=25^{\circ}C$ and $T_{TEC}=21^{\circ}C$

FIG. 1: OSE2 SPECTRUM

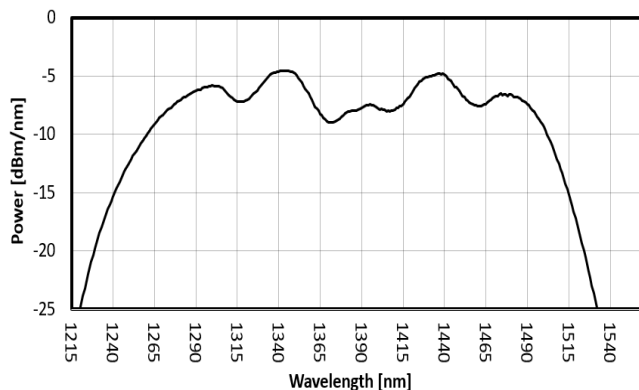

FIG. 2: SLED 1 SPECTRUM

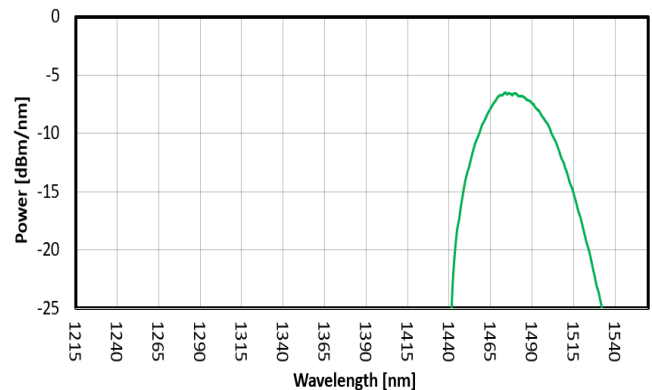

FIG. 3: SLED 2 SPECTRUM

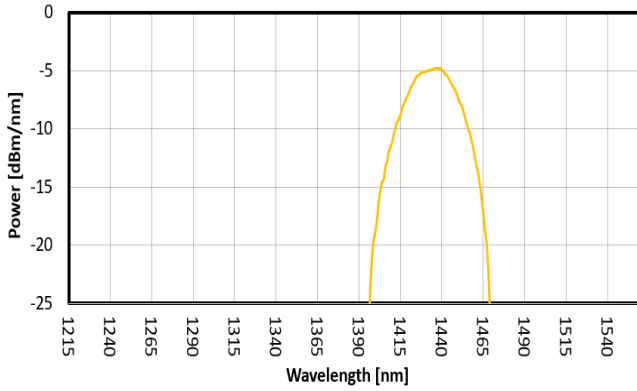

FIG. 4: SLED 3 SPECTRUM

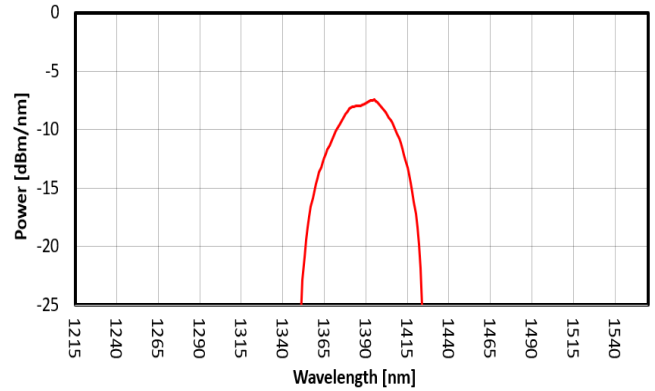

FIG. 5: SLED 4 SPECTRUM

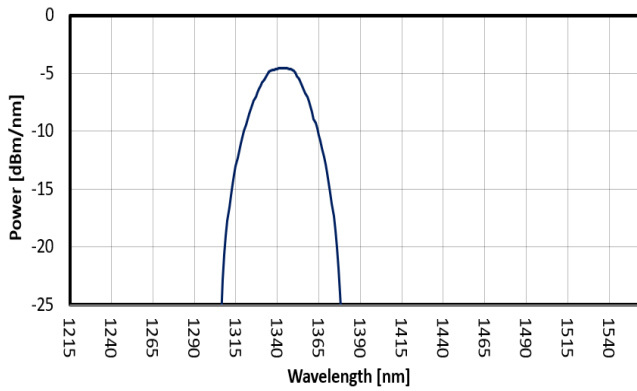

FIG. 6: SLED 5 SPECTRUM

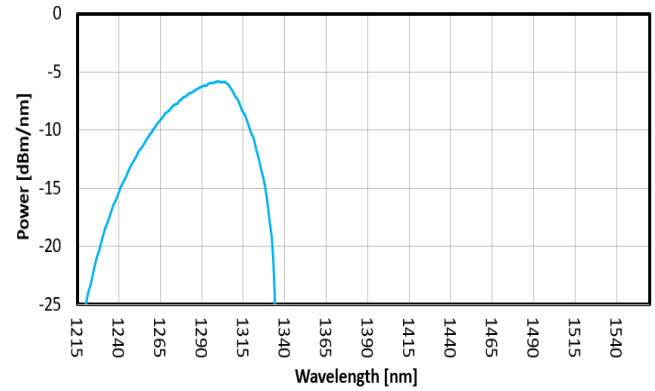

FIG. 7: SLED 1 OUTPUT POWER VS CURRENT

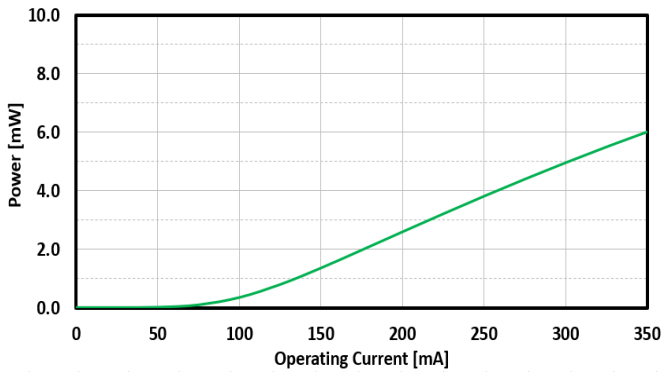

FIG. 8: SLED 2 OUTPUT POWER VS CURRENT

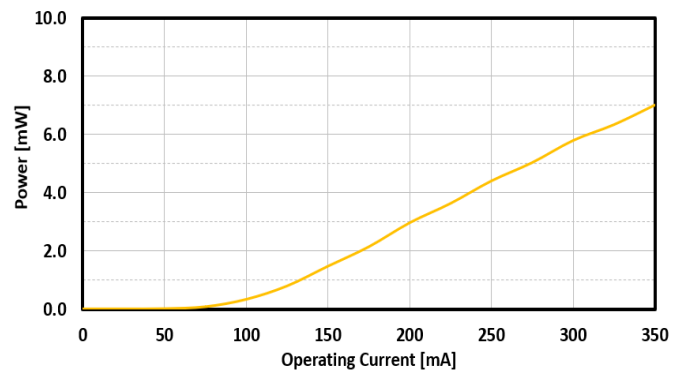

FIG. 9: SLED 3 OUTPUT POWER VS CURRENT

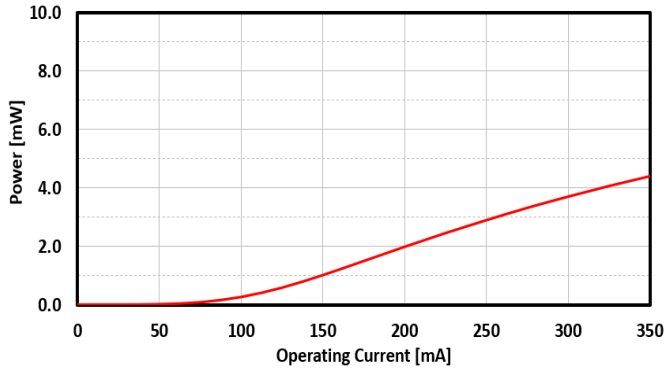

FIG. 10: SLED 4 OUTPUT POWER VS CURRENT

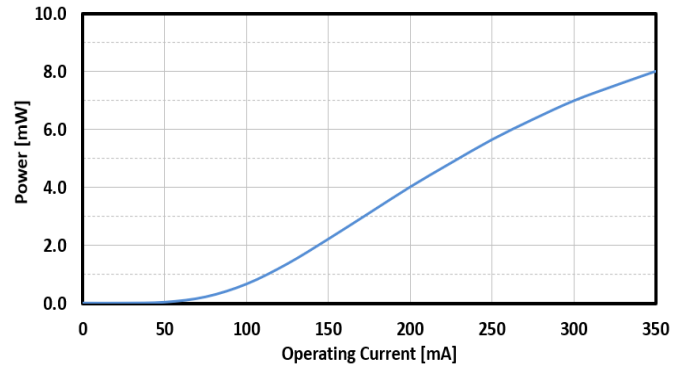

FIG. 11: SLED 5 OUTPUT POWER VS CURRENT

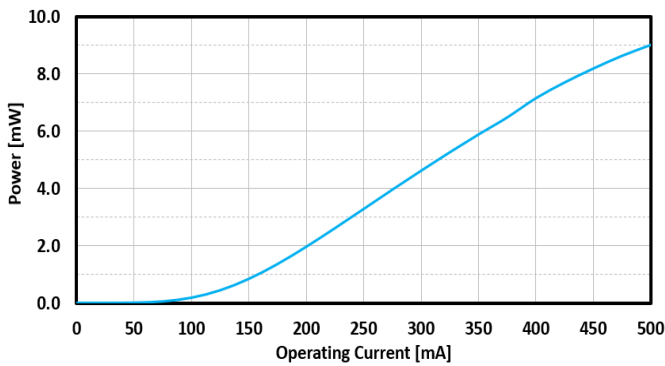

FIG. 12: SLED 1 FORWARD VOLTAGE VS CURRENT

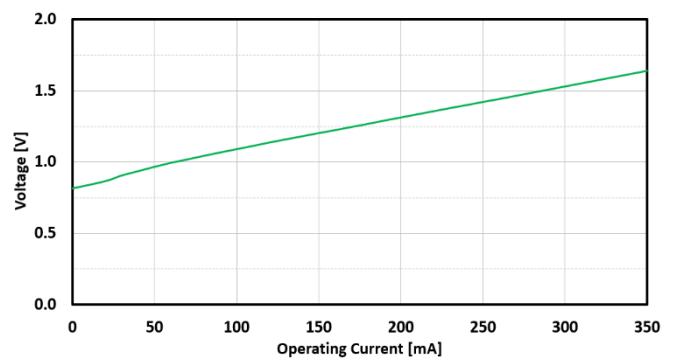

FIG. 13: SLED 2 FORWARD VOLTAGE VS CURRENT

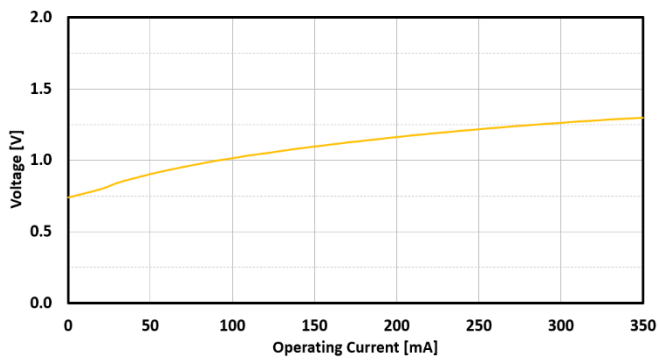

FIG. 14: SLED 3 FORWARD VOLTAGE VS CURRENT

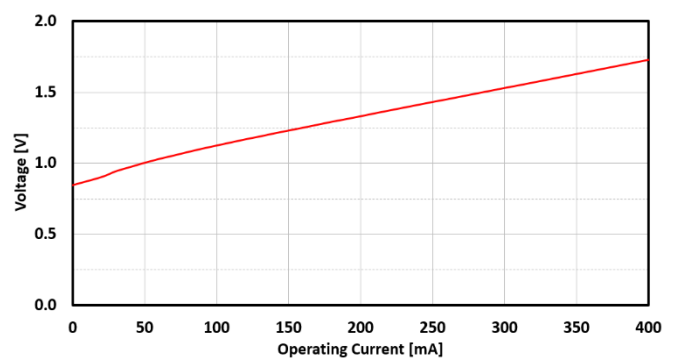

FIG. 15: SLED 4 FORWARD VOLTAGE VS CURRENT

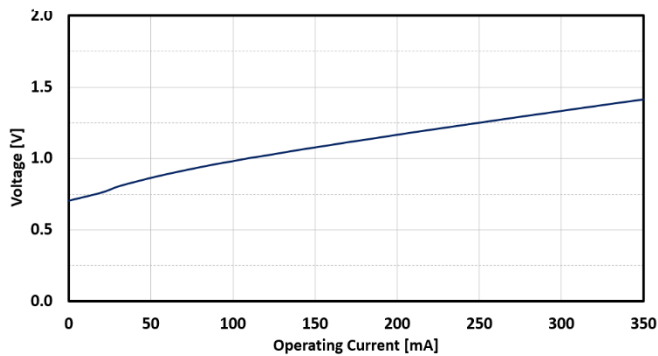

FIG. 16: SLED 5 FORWARD VOLTAGE VS CURRENT

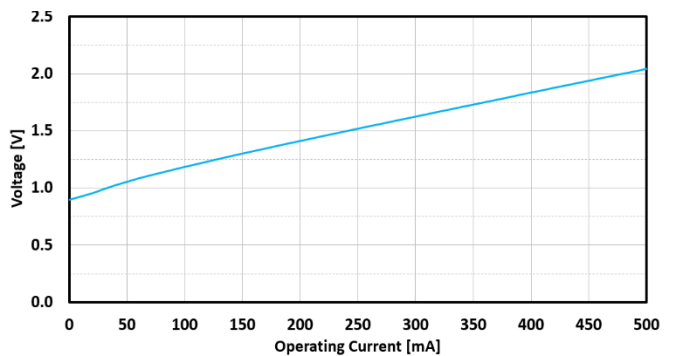
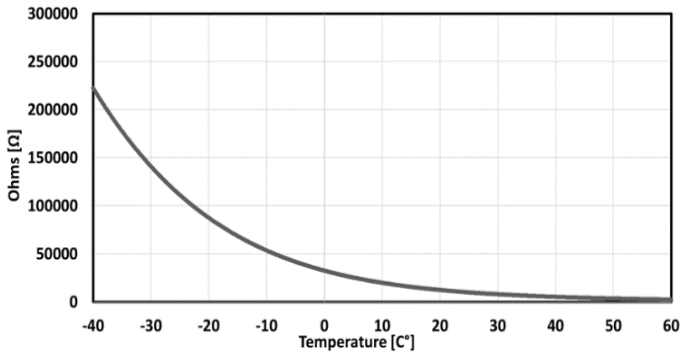
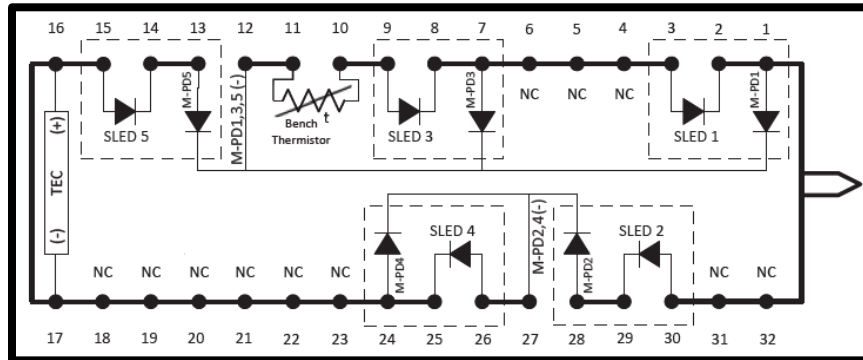

FIG. 17: THERMISTOR R_{THTEC} RESISTANCE VS TEMPERATURE



G. PIN OUT

External Pin Assignment – BeST-SLED: 5 SLEDs							
1	M-PD1 (+)	9	SLED 3(+)	17	TEC (-)	25	SLED 4 (-)
2	SLED 1 (-)	10	Thermistor	18	NC	26	SLED 4 (+)
3	SLED 1 (+)	11	Thermistor	19	NC	27	M-PD2,4 (-)
4	NC	12	M-PD1,3,5 (-)	20	NC	28	M-PD2 (+)
5	NC	13	M-PD5 (+)	21	NC	29	SLED 2 (-)
6	NC	14	SLED 5 (-)	22	NC	30	SLED 2 (+)
7	M-PD3 (+)	15	SLED 5 (+)	23	NC	31	NC
8	SLED 3 (-)	16	TEC (+)	24	M-PD4 (+)	32	NC



H. MECHANICAL DIAGRAM

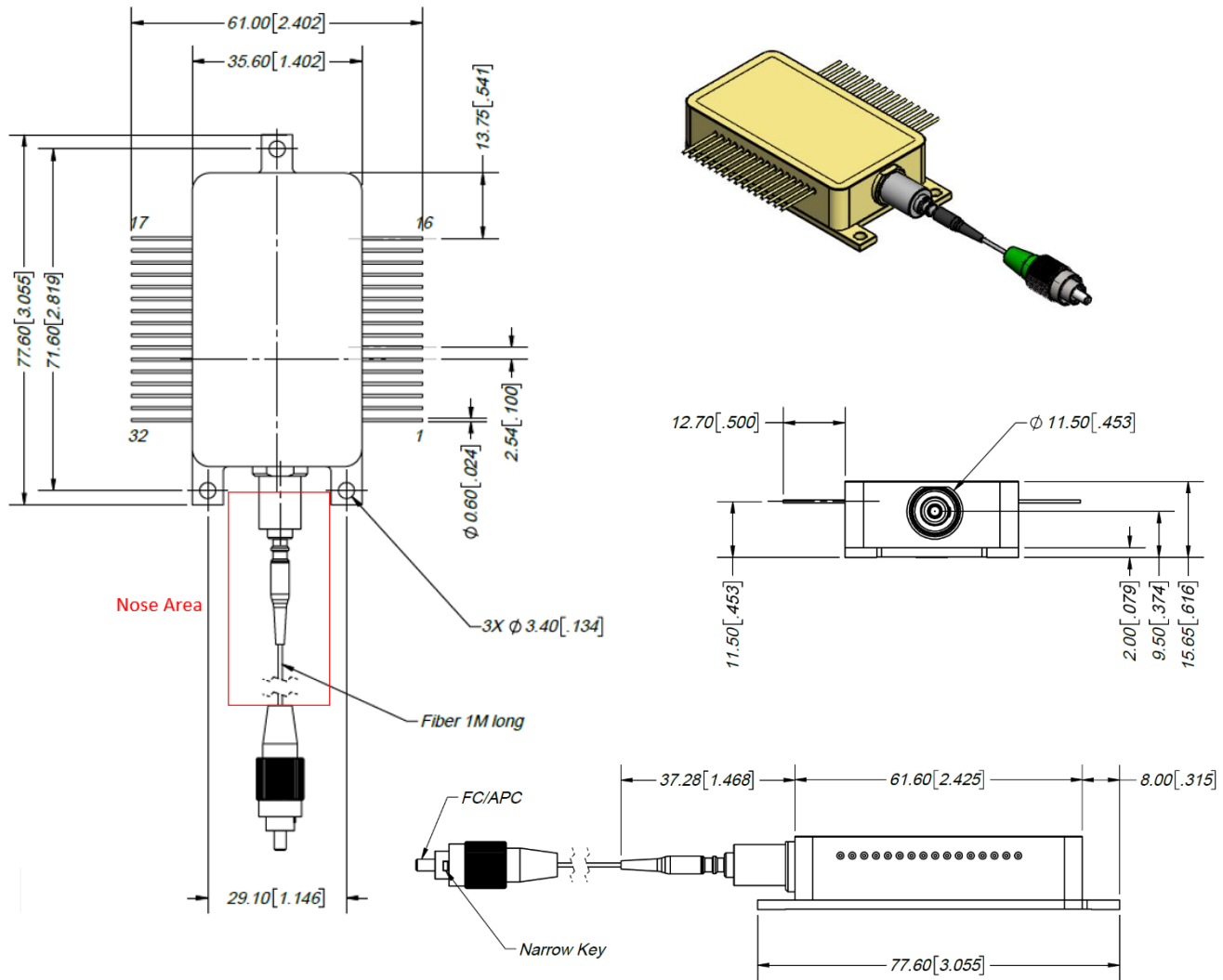

I. MOUNTING RECOMMENDATIONS:

The OSE2 can be mounted on a flat cooling surface without having to risk forming the pins. Mounting surface should be flat, with no physical obstructions underneath to cause any discontinuity in the surface flatness. If a heatsink is used, the base of the butterfly package will rest on the surface of a heatsink in order to cool the internal TEC.

Use only the 3mm mounting holes in the case of the BeST-SLED, Luxmux recommends the use of 18-8 Stainless Steel Socket Head Screw 5-40 Thread Size screws. Maximum torque to avoid damage to the device is 13 lb.in. /1.5 Nm. Minimum torque is 9 lb.in./1.1 Nm. Do not use self-tapping screws.

The OSE2 Light Source should be mounted so that mechanical vibrations cannot cause short circuits between leads. AZIMUTH 16 pin, 0.100" pitch Sockets are recommended. The 32 pins will rest on a pair of spring-loaded sockets and be squeezed between the contacts and a plastic clamp.



J. SAFETY

All statements regarding safety of operation and technical data will only apply when the unit is operated correctly.

The driver must not be operated in environments susceptible to explosion hazards. Do not obstruct the air ventilation slots. If any parts of the driver, or electronics are broken or exposed, contact Luxmux technical support and do not attempt to operate the unit.

The OSE2 is a Class 1M laser product. It is safe for all conditions of use except when passed through magnifying optics such as microscopes and telescopes. It produces a beam that is divergent. If light is re-focused use protective eye wear.

K. ORDERING CODE

ORDERING CODE:		LTC	OSE2	SLEDS	FT	DOP	SC	FWHM	CW	LOP
LTC	Luxmux Technology Corporation									
OSE2	Best-SLED® OSE G2									
SLEDS	SLED center wavelength, choose from one of the models in the table 1300nm, 1340nm, 1390nm, 1430nm, 1480nm, 1550nm, 1615nm, 1680nm [choose up to 6]									
FT	Fiber Type, choose 1: PM: Polarization Maintaining SM: Single Mode FS: Free Space									
DOP	HP: High Degree of Polarization									
SC	Spectral Coverage [nm]									
FWHM	Full Width Half Maximum [nm] (FWHM defined as the bandwidth from the lowest spectral dip)									
CW	Center Wavelength [nm]									
LOP	Light Output Power [mW]									

Product Code
Available Options
Taken From Table

#LTC-OSE2-1300_1340_1390_1430_1480-SM-HP-1265_1500-235-1383-35_DS_2021_08_05

This document is the property of Luxmux, and contains proprietary information. Luxmux reserves the right to make product design or specification changes without notice.



Redefining Spectral Boundaries

Part Number	Ordering Code: LTC-OSE2-(SLEDS)-(FT)-(DOP)-(SC)-(FWHM)-(CW)-(LOP)	SLEDS [nm]	FT	SC [nm]	FWHM [nm]	CW [nm]	LOP [mW]
ASM000001	LTC-OSE2-1615_1680-PM-HP-1575_1725-150-1650-12	1615, 1680	PM	1575 - 1725	150	1650	12
ASM000002	LTC-OSE2-1480_1550_1615-PM-HP-1435_1640-205-1538-18	1480, 1550, 1615	PM	1435 - 1640	205	1538	18
ASM000003	LTC-OSE2-1340_1390_1430-PM-HP-1310_1465-155-1388-20	1340, 1390, 1430	PM	1310 - 1465	155	1388	20
ASM000004	LTC-OSE2-1300_1340_1390_1430-PM-HP-1265_1465-200-1365-25	1300, 1340, 1390, 1430	PM	1265 - 1465	200	1365	25
ASM000005	LTC-OSE2-1480_1550_1615_1680-PM-HP-1435_1725-290-1580-25	1480, 1550, 1615, 1680	PM	1435 - 1725	290	1580	25
ASM000006	LTC-OSE2-1300_1340_1390_1430_1480-PM-HP-1265_1500-235-1383-35	1300, 1340, 1390, 1430, 1480	PM	1265 - 1500	235	1383	35
ASM000007	LTC-OSE2-1340_1390_1430_1480_1550-PM-HP-1305_1605-300-1455-35	1340, 1390, 1430, 1480, 1550	PM	1305 - 1605	300	1455	35
ASM000008	LTC-OSE2-1300_1390_1480_1550_1615_1680-PM-HP-1265_1725-460-1495-40	1300, 1390, 1480, 1550, 1615, 1680	PM	1265 - 1725	460	1495	40
ASM000009	LTC-OSE2-1480_1550-PM-HP-1435_1605-170-1520-12	1480, 1550	PM	1435 - 1605	170	1520	12
ASM000010	LTC-OSE2-1340_1390_1430_1480_1550_1615-PM-HP-1310_1640-330-1475-38	1340, 1390, 1430, 1480, 1550, 1615	PM	1310 - 1640	330	1475	38
ASM000011	LTC-OSE2-1300_1340_1390_1430_1480_1550-PM-HP-1265_1605-340-1435-40	1300, 1340, 1390, 1430, 1480, 1550	PM	1265 - 1605	340	1435	40
ASM000012	LTC-OSE2-1430_1480_1550-PM-HP-1410_1605-195-1508-19	1430, 1480, 1550	PM	1410 - 1605	195	1508	19
ASM000013	LTC-OSE2-1300_1340_1390-PM-HP-1265_1420-155-1343-20	1300, 1340, 1390	PM	1265 - 1420	155	1343	20
ASM000014	LTC-OSE2-1390_1430_1480-PM-HP-1355_1500-145-1428-19	1390, 1430, 1480	PM	1355 - 1500	145	1428	19
ASM000015	LTC-OSE2-1550_1615_1680-PM-HP-1515_1725-210-1620-18	1550, 1615, 1680	PM	1515 - 1725	210	1620	18
ASM000016	LTC-OSE2-1300_1340-PM-HP-1265_1365-100-1315-12	1300, 1340	PM	1265 - 1365	100	1315	12
ASM000017	LTC-OSE2-1390_1480_1550-PM-HP-1340_1610-270-1475-20	1390, 1480, 1550	PM	1340 - 1610	270	1475	20
ASM000018	LTC-OSE2-1300_1390_1480-PM-HP-1265_1500-235-1383-20	1300, 1390, 1480	PM	1265 - 1500	235	1383	20
ASM000019	LTC-OSE2-1390_1480_1550_1615_1680-PM-HP-1340_1725-385-1533-32	1390, 1480, 1550, 1615, 1680	PM	1340 - 1725	385	1533	32
ASM000020	LTC-OSE2-1550_1615-PM-HP-1530_1630-100-1580-10	1550, 1615	PM	1530 - 1630	100	1580	10

Part Number	Ordering Code: LTC-OSE2-(SLEDS)-(FT)-(DOP)-(SC)-(FWHM)-(CW)-(LOP)	SLEDS [nm]	FT	SC [nm]	FWHM [nm]	CW [nm]	LOP [mW]
ASM000101	LTC-OSE2-1615_1680-SM-HP-1575_1725-150-1650-12	1615, 1680	SM	1575 - 1725	150	1650	12
ASM000102	LTC-OSE2-1480_1550_1615-SM-HP-1435_1640-205-1538-18	1480, 1550, 1615	SM	1435 - 1640	205	1538	18
ASM000103	LTC-OSE2-1340_1390_1430-SM-HP-1310_1465-155-1388-20	1340, 1390, 1430	SM	1310 - 1465	155	1388	20
ASM000104	LTC-OSE2-1300_1340_1390_1430-SM-HP-1265_1465-200-1365-25	1300, 1340, 1390, 1430	SM	1265 - 1465	200	1365	25
ASM000105	LTC-OSE2-1480_1550_1615_1680-SM-HP-1435_1725-290-1580-25	1480, 1550, 1615, 1680	SM	1435 - 1725	290	1580	25
ASM000106	LTC-OSE2-1300_1340_1390_1430_1480-SM-HP-1265_1500-235-1383-35	1300, 1340, 1390, 1430, 1480	SM	1265 - 1500	235	1383	35
ASM000107	LTC-OSE2-1340_1390_1430_1480_1550-SM-HP-1305_1605-300-1455-35	1340, 1390, 1430, 1480, 1550	SM	1305 - 1605	300	1455	35
ASM000108	LTC-OSE2-1300_1390_1480_1550_1615_1680-SM-HP-1265_1725-460-1495-40	1300, 1390, 1480, 1550, 1615, 1680	SM	1265 - 1725	460	1495	40
ASM000109	LTC-OSE2-1480_1550-SM-HP-1435_1605-170-1520-12	1480, 1550	SM	1435 - 1605	170	1520	12
ASM000110	LTC-OSE2-1340_1390_1430_1480_1550_1615-SM-HP-1310_1640-330-1475-38	1340, 1390, 1430, 1480, 1550, 1615	SM	1310 - 1640	330	1475	38
ASM000111	LTC-OSE2-1300_1340_1390_1430_1480_1550-SM-HP-1265_1605-340-1435-40	1300, 1340, 1390, 1430, 1480, 1550	SM	1265 - 1605	340	1435	40
ASM000112	LTC-OSE2-1430_1480_1550-SM-HP-1410_1605-195-1508-19	1430, 1480, 1550	SM	1410 - 1605	195	1508	19
ASM000113	LTC-OSE2-1300_1340_1390-SM-HP-1265_1420-155-1343-20	1300, 1340, 1390	SM	1265 - 1420	155	1343	20
ASM000114	LTC-OSE2-1390_1430_1480-SM-HP-1355_1500-145-1428-19	1390, 1430, 1480	SM	1355 - 1500	145	1428	19
ASM000115	LTC-OSE2-1550_1615_1680-SM-HP-1515_1725-210-1620-18	1550, 1615, 1680	SM	1515 - 1725	210	1620	18
ASM000116	LTC-OSE2-1300_1340-SM-HP-1265_1365-100-1315-12	1300, 1340	SM	1265 - 1365	100	1315	12
ASM000117	LTC-OSE2-1390_1480_1550-SM-HP-1340_1610-270-1475-20	1390, 1480, 1550	SM	1340 - 1610	270	1475	20
ASM000118	LTC-OSE2-1300_1390_1480-SM-HP-1265_1500-235-1383-20	1300, 1390, 1480	SM	1265 - 1500	235	1383	20
ASM000119	LTC-OSE2-1390_1480_1550_1615_1680-SM-HP-1340_1725-385-1533-32	1390, 1480, 1550, 1615, 1680	SM	1340 - 1725	385	1533	32
ASM000120	LTC-OSE2-1550_1615-SM-HP-1530_1630-100-1580-10	1550, 1615	SM	1530 - 1630	100	1580	10

#LTC-OSE2-1300_1340_1390_1430_1480-SM-HP-1265_1500-235-1383-35_DS_2021_08_05

This document is the property of Luxmux, and contains proprietary information. Luxmux reserves the right to make product design or specification changes without notice.



Redefining Spectral Boundaries

Part Number	Ordering Code: LTC-OSE2-(SLEDs)-(FT)-(DOP)-(SC)-(FWHM)-(CW)-(LOP)	SLEDs [nm]	FT	SC [nm]	FWHM [nm]	CW [nm]	LOP [mW]
ASM000201	LTC-OSE2-1615_1680-FS-HP-1575_1725-150-1650-35	1615, 1680	FS	1575 – 1725	150	1650	35
ASM000202	LTC-OSE2-1480_1550_1615-FS-HP-1435_1640-205-1538-55	1480, 1550, 1615	FS	1435 – 1640	205	1538	55
ASM000203	LTC-OSE2-1340_1390_1430-FS-HP-1310_1465-155-1388-65	1340, 1390, 1430	FS	1310 – 1465	155	1388	65
ASM000204	LTC-OSE2-1300_1340_1390_1430-FS-HP-1265_1465-200-1365-90	1300, 1340, 1390, 1430	FS	1265 – 1465	200	1365	90
ASM000205	LTC-OSE2-1480_1550_1615_1680-FS-HP-1435_1725-290-1580-80	1480, 1550, 1615, 1680	FS	1435 – 1725	290	1580	80
ASM000206	LTC-OSE2-1300_1340_1390_1430_1480-FS-HP-1265_1500-235-1383-115	1300, 1340, 1390, 1430, 1480	FS	1265 – 1500	235	1383	115
ASM000207	LTC-OSE2-1340_1390_1430_1480_1550-FS-HP-1305_1605-300-1455-110	1340, 1390, 1430, 1480, 1550	FS	1305 – 1605	300	1455	110
ASM000208	LTC-OSE2-1300_1390_1480_1550_1615_1680-FS-HP-1265_1725-460-1495-125	1300, 1390, 1480, 1550, 1615, 1680	FS	1265 – 1725	460	1495	125
ASM000209	LTC-OSE2-1480_1550-FS-HP-1435_1605-170-1520-45	1480, 1550	FS	1435 – 1605	170	1520	45
ASM000210	LTC-OSE2-1340_1390_1430_1480_1550_1615-FS-HP-1310_1640-330-1475-120	1340, 1390, 1430, 1480, 1550, 1615	FS	1310 – 1640	330	1475	120
ASM000211	LTC-OSE2-1300_1340_1390_1430_1480_1550-FS-HP-1265_1605-340-1435-130	1300, 1340, 1390, 1430, 1480, 1550	FS	1265 – 1605	340	1435	130
ASM000212	LTC-OSE2-1430_1480_1550-FS-HP-1410_1605-195-1508-60	1430, 1480, 1550	FS	1410 – 1605	195	1508	60
ASM000213	LTC-OSE2-1300_1340_1390-FS-HP-1265_1420-155-1343-70	1300, 1340, 1390	FS	1265 – 1420	155	1343	70
ASM000214	LTC-OSE2-1390_1430_1480-FS-HP-1355_1500-145-1428-65	1390, 1430, 1480	FS	1355 – 1500	145	1428	65
ASM000215	LTC-OSE2-1550_1615_1680-FS-HP-1515_1725-210-1620-55	1550, 1615, 1680	FS	1515 – 1725	210	1620	55
ASM000216	LTC-OSE2-1300_1340-FS-HP-1265_1365-100-1315-50	1300, 1340	FS	1265 – 1365	100	1315	50
ASM000217	LTC-OSE2-1390_1480_1550-FS-HP-1340_1610-270-1475-60	1390, 1480, 1550	FS	1340 – 1610	270	1475	60
ASM000218	LTC-OSE2-1300_1390_1480-FS-HP-1265_1500-235-1383-70	1300, 1390, 1480	FS	1265 – 1500	235	1383	70
ASM000219	LTC-OSE2-1390_1480_1550_1615_1680-FS-HP-1340_1725-385-1533-100	1390, 1480, 1550, 1615, 1680	FS	1340 – 1725	385	1533	100
ASM000220	LTC-OSE2-1550_1615-FS-HP-1530_1630-100-1580-30	1550, 1615	FS	1530 – 1630	100	1580	30

#LTC-OSE2-1300_1340_1390_1430_1480-SM-HP-1265_1500-235-1383-35_DS_2021_08_05

This document is the property of Luxmux, and contains proprietary information. Luxmux reserves the right to make product design or specification changes without notice.

Luxmux Technology Corporation, 1030-2424 4th Street SW, Calgary, Canada, T2S 2T4
sales@luxmux.com, +1 (587) 392-6192, www.luxmux.com