

APPROVED: _____
 DATE: _____ TITLE: _____

Rev	AWO #	Description	Date	Appr
-		RELEASED	12/24/20	
A		UPDATE TITLE	6/25/21	JJ/RC

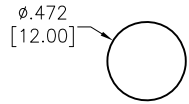

Mounting Hole

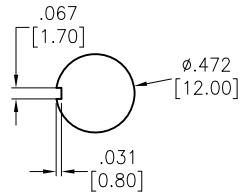

With Keyway

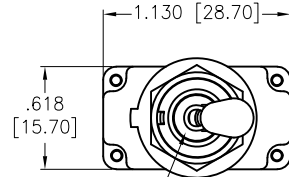

Internal O-ring Seal

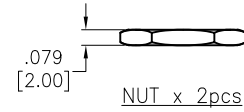
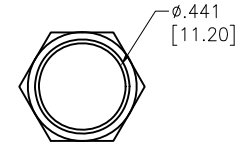

NUT x 2pcs

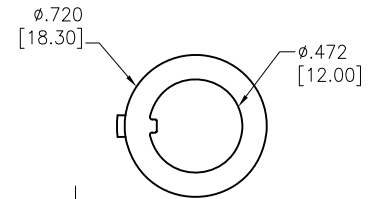

Locking Ring x 1pcs

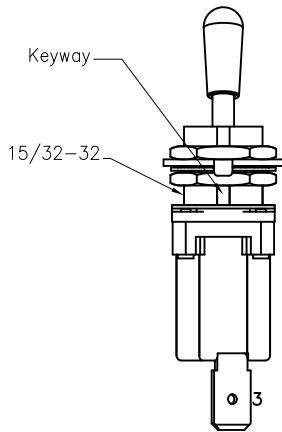

Keyway

15/32-32

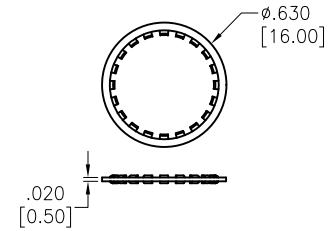
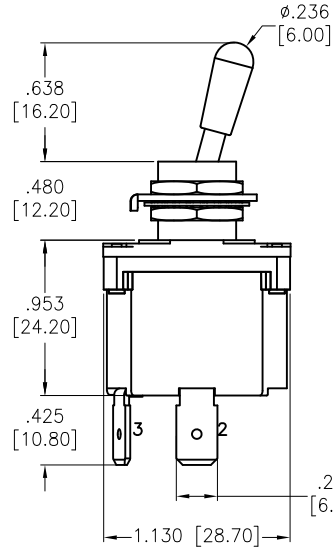

Washer x 1pcs

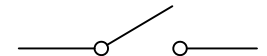

CIRCUIT DIAGRAM
(SPST) ON-OFF

SPECIFICATIONS:

Material:
 Movable contact: Copper Alloy, Silver plated
 Terminals: Brass, Tin plated
 Electrical:

Rating: 12A @ 125/250VAC
 1/2 HP 125VAC/ 1HP 250VAC/5A 125VAC

Contact resistance: 20 mohms max initial
 Insulation resistance: 100 Mohms min @ 500 VDC
 Dielectric withstanding voltage: 1500V RMS @ sea level
 Electrical life: 30,000 make and break cycles at full load

Temperature Rating:
 Operating temperature: -30°C to +85°C

Environmental:

IP68 Protection Class
 Lead free, RoHS compliant



UNLESS OTHERWISE SPECIFIED ALL DIMENSIONS ARE INCHES [MM]. TOLERANCES: EXCEPT AS NOTED

INCHES		HOLES	
.x	±.10	Øx	±.10
.xx	±.020	Øxx	±.015
.xxx	±.015	Øxxx	±.010

DRAWN	OW	12/24/20
CHECKED	AC	12/24/20
APPROVED		

THIS DRAWING CONTAINS INFORMATION THAT IS PROPRIETARY AND SHOULD NOT BE USED WITHOUT PRIOR WRITTEN PERMISSION FROM ADAM TECH



909 Rahway Avenue,
 Union, NJ 07083
 Phone: 908-687-5000
 Fax: 908-687-5710

TITLE		
POWER TOGGLE SWITCH, SPST, ON-ON, QC .250 [6.35MM]		

SIZE	PART NO.	REV.
X	SW-T4-1A-E-TA1-01	A
REF: S00198T	SCALE: NTS	SHEET 1 OF 1