

## Data sheet | Item number: 730-103

Socket; automatic L-disconnection; 3-pole; orange

[www.wago.com/730-103](http://www.wago.com/730-103)

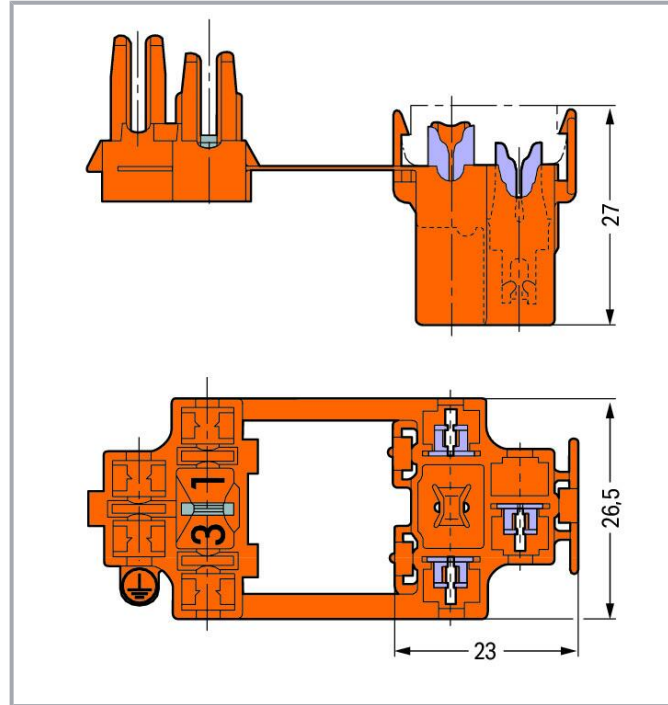
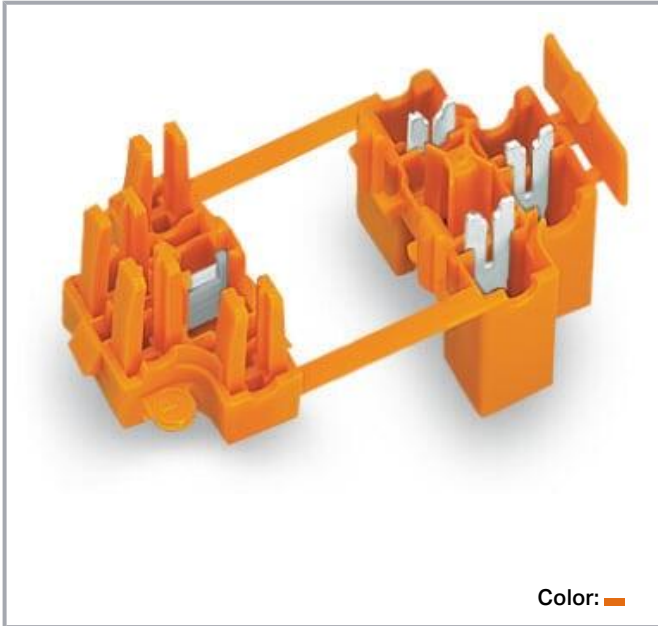

### Item description

- Sockets with IDC for tapping individual conductors without stripping
- Three-pole sockets automatically cut "live" conductors (e.g., door switches in elevator shafts)
- Sockets available with additional mounting flanges

### Data

#### Electrical data

#### Ratings per IEC/EN

Ratings per	IEC/EN 60664-1
Nominal voltage (III/3)	500 V
Rated impulse voltage (III/3)	6 kV
Rated voltage (III/2)	630 V
Rated impulse voltage (III/2)	6 kV

Subject to changes. Please also observe the further product documentation!

WAGO GmbH & Co. KG  
Hansastr. 27  
32423 Minden  
Phone: +49571 887-0 | Fax: +49571 887-169  
Email: [info.de@wago.com](mailto:info.de@wago.com) | Web: [www.wago.com](http://www.wago.com)

Do you have any questions about our products?  
We are always happy to take your call at +49 (571) 887-44222.



Nominal voltage (II/2)	1000 V
Rated surge voltage (II/2)	6 kV
Rated current	10 A
Legend (ratings)	(III / 2) $\hat{=}$ Overvoltage category III / Pollution degree 2

### Ratings per UL 1059

Approvals per	UL 1059
Rated voltage UL (Use Group C)	600 V
Rated current UL (Use Group C)	10 A

### Ratings per CSA

Approvals per	CSA
Rated voltage CSA (Use Group C)	600 V
Rated current CSA (Use Group C)	10 A

### Connection data

Total number of potentials	3
Number of connection types	1
Number of levels	1

### Connection 1

Connection technology	IDC connection
Fine-stranded conductor	0.75 ... 1.5 mm <sup>2</sup> / 18 ... 16 AWG
Pole number	3

### Physical data

Width	26.5 mm / 1.043 inches
Height	27 mm / 1.063 inches
Depth	23 mm / 0.906 inches

### Mechanical Data

Variable coding	No
-----------------	----

### Plug-in connection

Contact type (pluggable connector)	Female connector/socket
------------------------------------	-------------------------

Subject to changes. Please also observe the further product documentation!



Connector (connection type)	for conductor
Mismating protection	No

## Material Data

Note (material data)	Information on material specifications can be found here
Color	orange
Material group	I
Insulation material	Polyamide (PA66)
Flammability class per UL94	V0
Clamping spring material	Chrome-nickel spring steel (CrNi)
Contact material	Brass
Contact plating	Tin
Fire load	0.169 MJ
Weight	7.1 g

## Environmental requirements

Limit temperature range	-60 ... +85 °C
-------------------------	----------------

## Commercial data

Product Group	13 (Misc. Multi Conn. System)
eCl@ss 10.0	27-14-11-06
eCl@ss 9.0	27-14-11-06
ETIM 8.0	EC001284
ETIM 7.0	EC001284
PU (SPU)	50 pcs
Packaging type	box
Country of origin	CN
GTIN	4050821429715
Customs tariff number	85366990990

## Environmental Product Compliance

RoHS Compliance Status	Compliant, No Exemption
------------------------	-------------------------



## Approvals / Certificates

### General approvals

Subject to changes. Please also observe the further product documentation!

WAGO GmbH & Co. KG  
 Hansastr. 27  
 32423 Minden  
 Phone: +49571 887-0 | Fax: +49571 887-169  
 Email: [info.de@wago.com](mailto:info.de@wago.com) | Web: [www.wago.com](http://www.wago.com)

Do you have any questions about our products?  
 We are always happy to take your call at +49 (571) 887-44222.

Logo	Approval	Additional Approval Text	Certificate name
	CCA DEKRA Certification B.V.	EN 60998	2174149.01 A
	CSA DEKRA Certification B.V.	C22.2 No. 158	LR 18677- 43
	UL UL International Germany GmbH	UL 1059	E45172

## Optional accessories

### Testing and measuring

#### Testing accessories



Item no.: 210-136

Test plug; 2 mm Ø; with 500 mm cable; red

[www.wago.com/210-136](http://www.wago.com/210-136)

### Tool

#### Operating tool



Item no.: 210-719

Operating tool; Blade: 2.5 x 0.4 mm; with a partially insulated shaft

[www.wago.com/210-719](http://www.wago.com/210-719)

## Downloads

### Documentation

#### Additional Information

Technical Section	2019 Apr 3	pdf	Download
Technical explanations		2.0 MB	

## CAD/CAE-Data

### CAD data

2D/3D Models 730-103	URL	Download
----------------------	-----	----------

### CAE data

Subject to changes. Please also observe the further product documentation!

WSCAD Universe 730-103

[URL](#)

[Download](#)

ZUKEN Portal 730-103

[URL](#)

[Download](#)

## Environmental Product Compliance

### Compliance Search

Environmental Product Compliance 730-103

[URL](#)

[Download](#)

Socket; automatic L-disconnection; 3-pole; orange

## Installation Notes

### Conductor termination

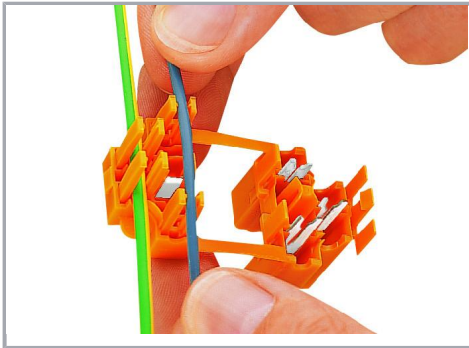

Press conductors into strain relief fingers.

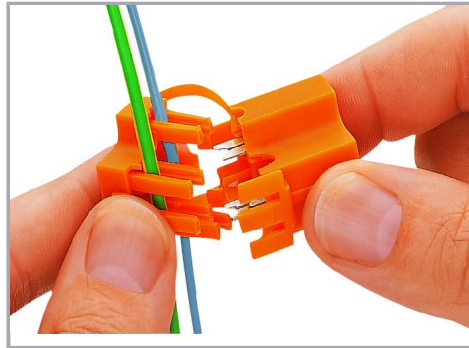

Place upper and lower part of the socket into pre-locking position.

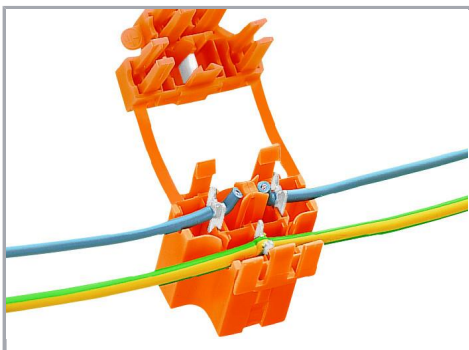

Three-pole socket (open)

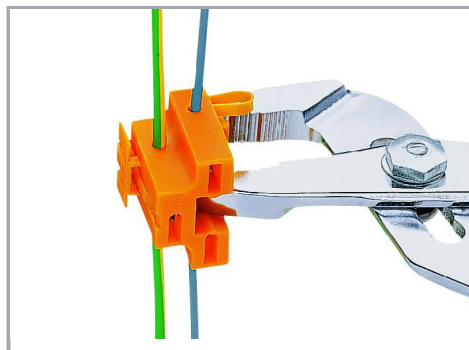

Press into final position using pliers.

Subject to changes. Please also observe the further product documentation!

WAGO GmbH & Co. KG

Hansastr. 27

32423 Minden

Phone: +49571 887-0 | Fax: +49571 887-169

Email: [info.de@wago.com](mailto:info.de@wago.com) | Web: [www.wago.com](http://www.wago.com)

Do you have any questions about our products?

We are always happy to take your call at +49 (571) 887-44222.