

Data sheet | Item number: 859-804

DC/DC Converter; 12 VDC input voltage; 24 VDC output voltage; 0.25 A output current; 2,50 mm²; gray

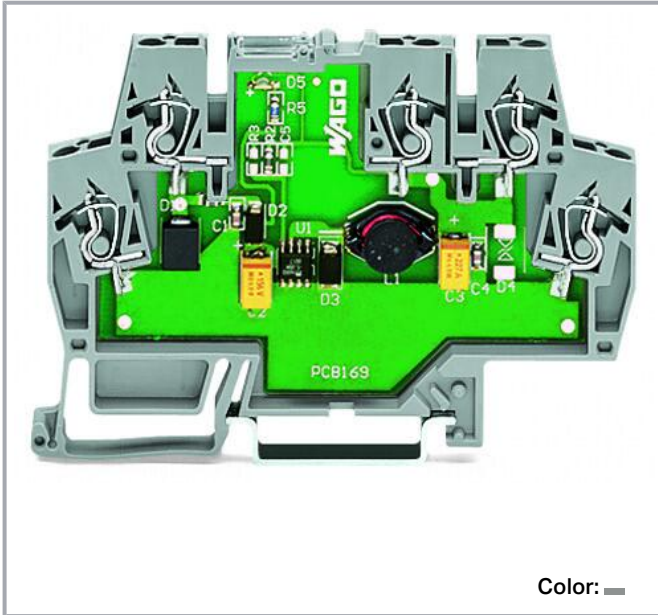

www.wago.com/859-804



Color:

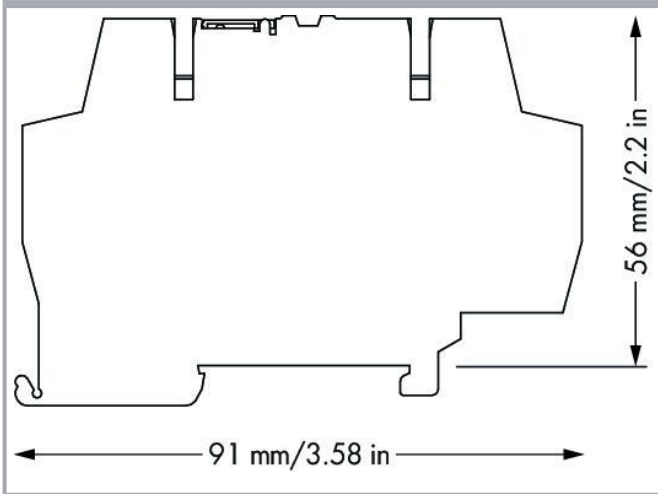
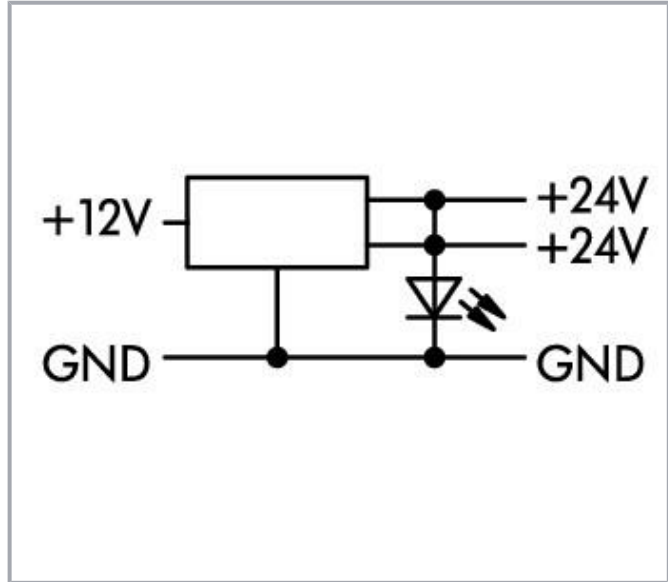

Data
Technical data

Subject to changes. Please also observe the further product documentation!

WAGO GmbH & Co. KG
Hansastr. 27
32423 Minden
Phone: +49571 887-0 | Fax: +49571 887-169
Email: info.de@wago.com | Web: www.wago.com

Do you have any questions about our products?
We are always happy to take your call at +49 (571) 887-44222.



Input

Nominal input voltage $U_{i\text{nom}}$	DC 12 V
Input voltage range	DC 8 ... 16 V
Nominal mains frequency range	0 Hz
Mains failure hold-up time	≥ 0.5 ms

Output

Nominal output voltage $U_{o\text{nom}}$	DC 24 V
Output voltage range	± 1 %
Nominal output current $I_{o\text{nom}}$	0.25 A
Residual ripple	≤ 40 mV
Switching frequency	1.2 MHz (nominal)
Overload behavior	Fuse

Signaling and Communication

Signaling	1 x LED
-----------	---------

Efficiency/power losses

Efficiency (typ.)	83 %
-------------------	------

Circuit protection

Internal fuse	TVS diode
---------------	-----------

Safety and protection

Protection class	III
Protection type	IP20; per EN 60529
Reverse voltage protection	yes
Pollution degree	2
Series operation	No

Connection data

Number of jumper slots	2
Connection technology	CAGE CLAMP®

Subject to changes. Please also observe the further product documentation!



WAGO connector	WAGO 859 Series
Solid conductor	0.08 ... 2.5 mm ² / 28 ... 14 AWG
Fine-stranded conductor	0.08 ... 2.5 mm ² / 28 ... 14 AWG
Strip length	5 ... 6 mm / 0.2 ... 0.24 inches

Physical data

Width	6 mm / 0.236 inches
Height	91 mm / 3.583 inches
Height from upper-edge of DIN-rail	56 mm / 2.205 inches
Depth	91 mm / 3.583 inches
Depth from upper-edge of DIN-rail	56 mm / 2.205 inches

Mechanical Data

Mounting type	DIN-35 rail
---------------	-------------

Material Data

Color	gray
Fire load	0.48 MJ
Weight	28.8 g

Environmental requirements

Ambient temperature (operation)	-25 ... +55 °C
---------------------------------	----------------

Standards and specifications

Conformity marking	CE
--------------------	----

Commercial data

Product Group	6 (INTERFACE ELECTRONIC)
eCl@ss 10.0	27-04-07-01
eCl@ss 9.0	27-04-07-01
ETIM 8.0	EC002540
ETIM 7.0	EC002540
PU (SPU)	10 (1) pcs
Packaging type	box
Country of origin	US
GTIN	4050821017479

Subject to changes. Please also observe the further product documentation!

Customs tariff number

85044083900

Environmental Product Compliance

RoHS Compliance Status

Compliant, No Exemption

Approvals / Certificates

General approvals

Logo	Approval	Additional Approval Text	Certificate name
	EAC Brjansker Zertifizierungsstelle	TP TC 004/2011	EAC RU C-DE.AM02.B.00122/19

Optional accessories

Tool

Operating tool

**Item no.: 210-720**

Operating tool; Blade: 3.5 x 0.5 mm; with a partially insulated shaft; multicoloured

www.wago.com/210-720

Marking accessories

Marking devices

**Item no.: 210-110**

Fiber-tip pen

www.wago.com/210-110

Marker

**Item no.: 2009-145**

Mini-WSB Inline; for Smart Printer; 1700 pieces on roll; stretchable 5 - 5.2 mm; plain; snap-on type; white

www.wago.com/2009-145**Item no.: 248-501**

Mini-WSB marking card; as card; not stretchable; plain; snap-on type; white

www.wago.com/248-501**Item no.: 248-503**

Mini-WSB marking card; as card; MARKED; 11 ... 20 (10x); not stretchable; Horizontal marking; snap-on type; white

www.wago.com/248-503**Item no.: 248-506**

Mini-WSB marking card; as card; MARKED; 41 ... 50 (10x); not stretchable; Horizontal marking; snap-on type; white

www.wago.com/248-506**Item no.: 248-502**

Mini-WSB marking card; as card; MARKED; 1 ... 10 (10x); not stretchable; Horizontal marking; snap-on type; white

www.wago.com/248-502

Subject to changes. Please also observe the further product documentation!

WAGO GmbH & Co. KG

Hansastr. 27



32423 Minden

Phone: +49571 887-0 | Fax: +49571 887-169

Email: info.de@wago.com | Web: www.wago.com

Do you have any questions about our products?

We are always happy to take your call at +49 (571) 887-44222.

	Item no.: 793-501 WMB marking card; as card; not stretchable; plain; snap-on type; white	www.wago.com/793-501
	Item no.: 793-5501 WMB marking card; as card; for terminal block width 5 - 17.5 mm; stretchable 5 - 5.2 mm; plain; snap-on type; white	www.wago.com/793-5501
End plate		
Intermediate plate		
	Item no.: 859-525 End and intermediate plate; 1 mm thick; gray	www.wago.com/859-525

Downloads

Documentation

Bid Text

859-804 X81 - Datei	2019 Feb 19	xml 4.1 kB	Download
859-804 doc - Datei	2015 Feb 6	doc 26.6 kB	Download

Instruction Leaflet

DC/DC-Wandler		pdf 68.8 kB	Download
---------------	--	----------------	----------

Additional Information

Disposal and Recycling Electrical and electronic equipment, Batteries, Packaging	V 1.1.0 2022 Aug 18	pdf 2.2 MB	Download
---	------------------------	---------------	----------

CAD/CAE-Data

CAD data

2D/3D Models 859-804		URL	Download
----------------------	--	-----	----------

CAE data

EPLAN Data Portal 859-804		URL	Download
ZUKEN Portal 859-804		URL	Download

Subject to changes. Please also observe the further product documentation!



WSCAD Universe 859-804

[URL](#)

[Download](#)

Environmental Product Compliance

Compliance Search

Environmental Product Compliance 859-804

[URL](#)

[Download](#)

DC/DC Converter; 12 VDC input voltage; 24 VDC output voltage; 0.25 A output current; 2,50 mm²; gray

Installation Notes

Subject to changes. Please also observe the further product documentation!

WAGO GmbH & Co. KG

Hansastr. 27

32423 Minden

Phone: +49571 887-0 | Fax: +49571 887-169

Email: info.de@wago.com | Web: www.wago.com

Do you have any questions about our products?

We are always happy to take your call at +49 (571) 887-44222.