

# Boost 4 click schematic v100

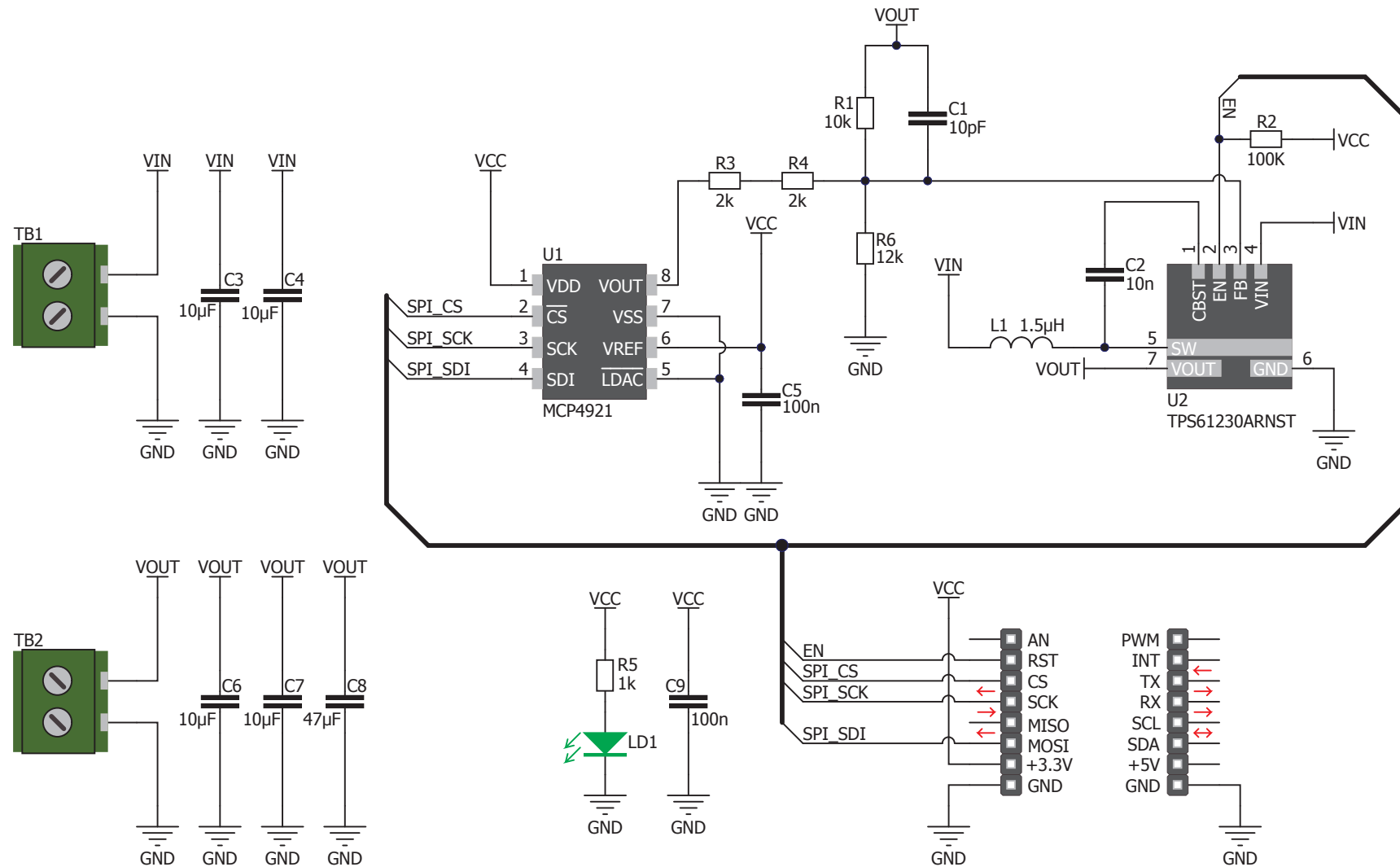

[www.mikroe.com](http://www.mikroe.com)