

Digital Force Gauge with SD Memory

Models 475040-SD (5kg) and 475044-SD (20kg)

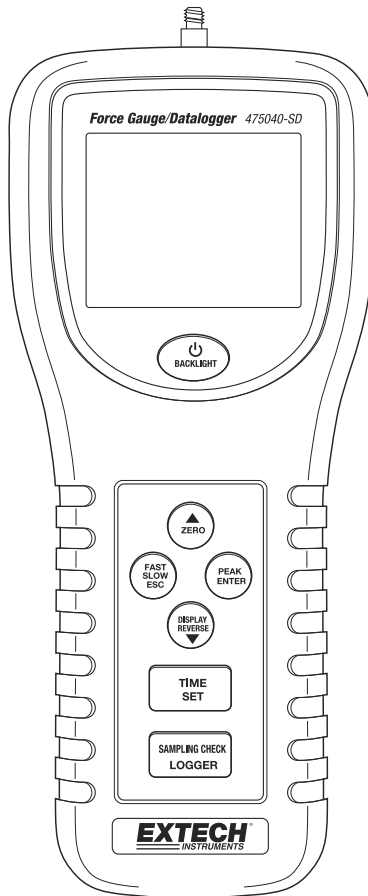

Introduction

Congratulations on your purchase of this Extech Meter. This meter is shipped fully tested and calibrated and, with proper use, will provide years of reliable service.

Meter Description

- 1 Universal Sensing Head
- 2 LCD Display
- 3 Power/BACKLIGHT Button
- 4 ▲/ZERO Button
- 5 Fast/SLOW/ESC Button
- 6 DISPLAY REVERSE/ ▼ Button
- 7 TIME/SET Button
- 8 LOGGER/SAMPLING CHECK Button
- 9 PEAK/ENTER Button
- 10 SD card socket (side)
- 11 RS-232 output terminal
- 12 Reset button
- 13 AC Adapter Input Socket

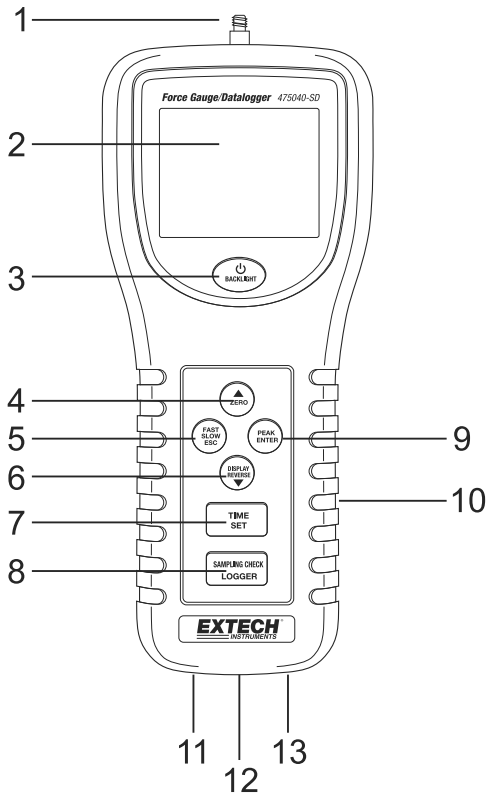

Accessories

- 1 Flat-head Adaptor
- 2 Cone adaptor
- 3 Chisel adaptor
- 4 Hook Adaptor
- 5 120mm Extension Rod

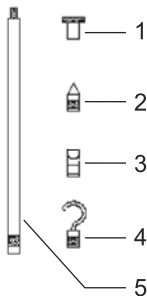

METER BACK AND MOUNTING SCREW DESCRIPTION

1. Mounting screws:

Hex head (#4 Allen wrench) with a thread size of metric (ISO) M5 x 0.8. The spacing between screws is 60.0 mm (2.36")

2. Battery compartment access screws

3. Battery compartment

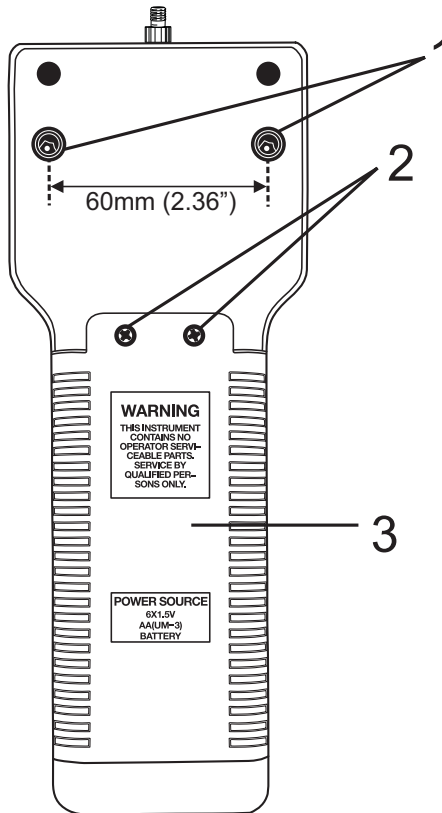

Getting Started

Tension and Compression

The meter automatically indicates TENSION (pull) or COMPRESSION (push) force during use. Compression displays as a negative (-) value and Tension displays as a positive value.

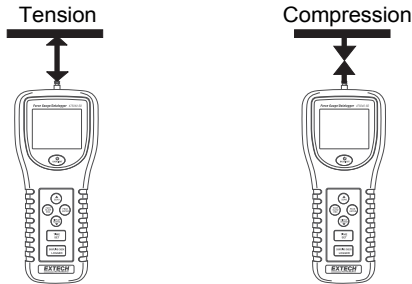

Attaching measurement Adaptors

Attach the adapter to the Sensing Head. Choose the adaptor to match the type of measurement to be performed

Sensing Head Alignment

The sensing head with adapter must be in line with the object being measured. Avoid rotating the sensing head.

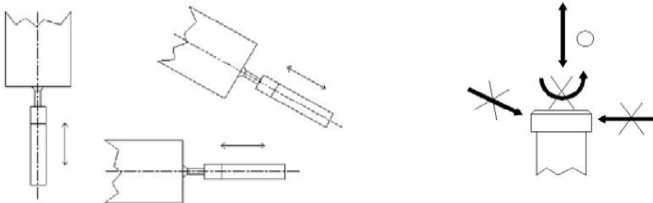

Setup

Refer to the Setup Menu section of this manual to:

- Format the SD memory card
- Set the clock time
- Set the sampling time for the record mode
- Set the sampling time for the peak record mode
- Set the auto-power off status
- Set the beeper on/off
- Set the measurement units
- Set the SD card decimal character

Operating Procedure

Normal Measurement

1. Press the Power button to turn the meter ON. Press and HOLD the Power button for >2seconds to turn the meter OFF.
2. If necessary, change the displayed units. See the Setup Menu section
3. Zero the meter by pressing the ZERO button.
4. Apply the force and the average reading will be displayed on the LCD.
5. If necessary, press the DISPLAY REVERSE button to invert the display.
6. Press the FAST SLOW button to change the response time.

Peak Hold Measurement

1. Press the PEAK button to enter the Peak Hold mode. The "PEAK" icon will be displayed.
2. The operation in Peak mode is identical to the Normal mode except the peak measured value will be held and displayed.

Over Range Display

If the force measured exceeds the range of the meter, the display will indicate "-----" for tension or "-----" for compression.

LCD Back Light On/Off

Press the BACKLIGHT button to turn the backlight ON. Press again to turn it OFF.

Alarm Beeper

If the measured value exceeds the maximum range, the internal buzzer will sound a warning.

Display Reverse

Press the display reverse button to invert the reading and provide readability in any position..

System Reset

If the meter's buttons freeze, press the RESET button on the bottom of to reset the CPU.

Auto Power Off

If auto power off is enabled in the setup mode, after 10 minutes of inactivity the meter will beep and then shut down. This feature extends battery life.

Mounting the Meter

Two mounting holes and hex screws are located on the rear of the meter to permit securing the meter to a fixture or test stand.

RS232 Output

The meter can stream data to a PC using the optional software.

Datalogger

Preparation for datalogger

1. Insert an SD card (from 1G size up to 16G, \leq 4G recommended) into the SD card slot at the bottom of the meter. The card must be inserted with the front of the card (label side) facing toward the rear of the meter.
2. If the SD card is being used for the first time it is recommended that the card be formatted and the logger's clock set to allow for accurate date/time stamping during datalogging sessions. Refer to the Setup Mode section for SD card formatting and time/date setting instructions.
3. European and USA numerical formats differ. The data on the SD card can be formatted for either format. The meter defaults to USA mode where a decimal point is used to separate units from tenths, i.e. **20.00**. The European format uses a comma, i.e. **20,00**. To change this setting, refer to the Setup Mode section.

Automatic Datalogging

In automatic datalogging mode the meter takes and stores a reading at a user-specified sampling rate onto an SD memory card. The meter defaults to a sampling rate of two seconds. To change the sampling rate, refer to the Setup Mode section (the sampling rate cannot be '0' for automatic datalogging):

1. To begin an automatic Datalogging session, press and hold the LOGGER button for at least 2 seconds.
2. The meter will scan for an SD card and verify that it can be used to store data. If a card is not inserted or if the card is defective, the meter will display a blinking 'EMPTY'. In this case, switch the meter OFF and try again with a valid SD card.
3. If the SD card is valid, the display will display a flashing "DATA RECORD" icon and the meter will beep (if the beeper is enabled) each time reading is stored at the programmed sample rate.
4. To pause the datalogger, momentarily press the LOGGER button. The REC icon will stop flashing. To resume logging momentarily press the LOGGER button again.
5. To end the datalogging session press and hold the LOG button for at least 2 seconds.

Manual Datalogging

In the manual mode, data is logged when the LOGGER button is pressed.

1. Set the sampling rate to '0' seconds as described in the Setup Mode section.
2. Press and hold the LOG button for at least 2 seconds; the lower portion of the display will show $p-n$ (n = memory position number 1-99).
3. Press the LOGGER button momentarily to log a reading into memory. The "DATA RECORD" icon will flash each time a data point is stored.
4. Use the ▲ and ▼ buttons to select one of the 99 data memory positions in which to record.
5. To exit the manual datalogging mode, press and hold the LOGGER button for at least 2 seconds.

Peak Hold Datalogging

1. Power on the meter
2. Press the PEAK button. The display "PEAK" and "FAST" icons will appear.
3. Press the ZERO button to zero the display.
4. Press the "LOGGER" button. The LCD will indicate "DATA RECORD" at the programmed peak hold sampling time, in milliseconds, will briefly appear on the bottom of the LCD. (for example "10"). Now the meter is ready for the Peak Hold record mode (Fast Datalogger measurement)
5. If a force is applied which is >1% of full capacity then measurements will be made and stored at the sample rate.
6. When the peak value is logged, the meter will exit the "DATA RECORD" mode and the peak value will freeze on the Display
7. On the bottom of the LCD the data record number will display and count down to zero. At the same time, all the memory data will save into the SD memory card

Note: Peak measurements should be performed with the meter mounted on a stand.

Checking Time information

1. Power on to the normal measurement mode
2. Press the TIME button and the lower display will indicate the Hour/Minute/Second.
3. Press TIME again and the lower display will indicate the Year/Month/Date.
4. Press TIME again to exit time information.

Checking Sampling Time information

1. Power on to the normal measurement mode
2. Press the SAMPLING CHECK button and the set sampling time will briefly appear in the lower display

SD Card File and Data structure

1. When an SD card is used for the first time a folder is created on the card and named **FGA01**. Up to 99 spreadsheet documents (each with 30,000 readings) can be stored in this folder.
2. When datalogging begins a new spreadsheet document named **FGA01001.xls** is created on the SD card in the FGA01 folder. The data recorded will be placed in the FGA01001.xls document until 30,000 readings are reached.
3. If the measurement session exceeds 30,000 readings, a new document will be created (FGA01002.xls) where another 30,000 readings can be stored. This method continues for up to 99 documents, after which another folder is created (FGA02) where another 99 spreadsheet documents can be stored. This process continues in this same fashion with folders FGA03 through FGA10 (last allowable folder).

SD Data Card to PC Data Transfer

1. Complete a datalogging session as detailed in above in the previous sections. Hint: For the first test, simply record a small amount of test data. This is to ensure that the datalogging process is well understood before committing to critical datalogging.
2. With the meter switched OFF, remove the SD Card.
3. Plug the SD Card directly into a PC SD card reader. If the PC does not have an SD card slot, use an SD card adaptor
4. Power the PC and run a spreadsheet software program. Open the saved documents in the spreadsheet software program

Example Excel data screen, Normal Mode

	A	B	C	D	E
1	Position	Date	Time	Ch1_Value	Ch1_Unit
2	1	2010/8/29	04:21:03	-369	g
3	2	2010/8/29	04:21:04	-369	g
4	3	2010/8/29	04:21:06	-369	g
5	4	2010/8/29	04:21:08	-385	g
6	5	2010/8/29	04:21:10	-327	g
7	6	2010/8/29	04:21:12	-369	g
8	7	2010/8/29	04:21:14	-390	g
9	8	2010/8/29	04:21:16	-330	g
10	9	2010/8/29	04:21:18	-347	g
11	10	2010/8/29	04:21:20	-346	g
12	11	2010/8/29	04:21:22	-311	g
13	12	2010/8/29	04:21:24	-262	g
14	13	2010/8/29	04:21:26	-261	g
15	14	2010/8/29	04:21:28	-260	g
16	15	2010/8/29	04:21:30	-305	g

Example Excel data screen, Peak Mode

J38						
	A	B	C	D	E	F
15	PeakHold	Chn_Value	Unit	SampleTime	Start Date	Start Time
16	P0000	-167	g	10mS	2010/8/29	04:21:48
17	P0001	-167	g			
18	P0002	-167	g			
19	P0003	-398	g			
20	P0004	-398	g			
21	P0005	-398	g			
22	P0006	-467	g			
23	P0007	-467	g			
24	P0008	-467	g			
25	P0009	-585	g			
26	P0010	-585	g			
27	P0011	-585	g			
28	P0012	-585	g			
29	P0013	-595	g			
30	P0014	-595	g			
31	P0015	-595	g			

Example Excel data screen

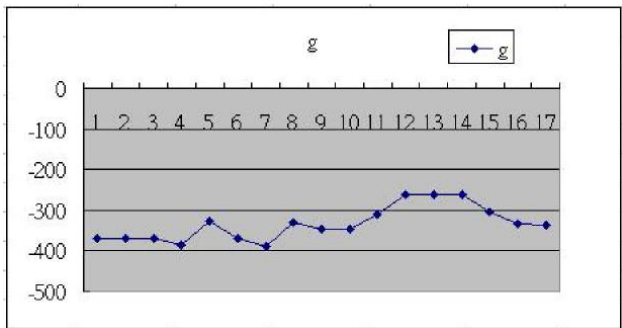

Setup Menu

In the Normal mode, press and Hold the SET Button >2 seconds to enter the Setup mode. With each press of the SET button the programmable functions will appear in this order:

SdF	SD memory card Format
dAtE	Set clock time (Year/Month/Date, Hour/Minute/Second)
SP-t	Set sampling time for normal record mode
HSPt	Set sampling time for peak record mode
PoFF	Auto power OFF enable/disable
bBEEP	Set beeper sound ON/OFF
unit	Set the measurement unit
dEC	Set SD card Decimal character
ESC	Escape or exit from the setup mode

Sd F - SD Card Formatting

1. Use the arrow buttons to select "yES" to format the card (select "no" to exit).
Note: All data on the card will be lost if formatting is performed.
2. If "yES" is selected, press ENTER to confirm selection and then press ENTER a second time to confirm the selection.
3. When the formatting is complete, the meter will return to the normal operating mode.

dAtE - Set Clock Time (Year/Month/Date, Hour/Minute/ Second)

1. Use the ▲ button or ▼ button to adjust the flashing digits to the correct setting.
2. When the desired value is set, press the ENTER button and the adjustment will move to the next value for adjustment.
3. Repeat this for the six values.
4. Press the SET button to save the setting and move to the next function.

Note: The clock data will remain set, even with power off, as long as the batteries are have a charge.

SP-t - Set Sampling Time (normal record mode)

1. Use the ▲ button or ▼ button to adjust the flashing digits to the desired setting.
2. When the desired value is set, press the ENTER button and the adjustment will move to the next value for adjustment.
3. Repeat this for the three values.
4. Press the SET button to save the setting and move to the next function.

Note: The default sample rate is 2 seconds.

HSPt - Set Peak Sampling Time (peak record mode)

1. Use the ▲ button or ▼ button to adjust the digits to the desired setting. The adjustment range is 10ms to 500ms in 10ms steps.
2. When the desired value is set, press the ENTER button to store the setting.
3. Press the SET button to move to the next function.

Note: Maximum of 1000 data points can be stored in the Peak mode.

PoFF - Auto Power ON/OFF

1. Use the ▲ button or ▼ button to select "yES" or "no".
yES - Auto Power Off is enabled
no - Auto Power Off is disabled
2. When the desired condition is set, press the ENTER button to store the setting.

bEEP - Beeper ON/OFF

1. Use the ▲ button or ▼ button to select "yES" or "no".
yES - Beeper is enabled
no - Beeper is disabled
2. When the desired condition is set, press the ENTER button to store the setting.

Unit - Set the Measurement Units

1. Use the ▲ button or ▼ button to select the units.
g (grams)
oz (ounce)
N (Newton)
2. When the desired units are set, press the ENTER button to store the setting.

dEC – SD Card Numerical Format (comma or decimal)

European and USA numerical formats differ. The meter defaults to USA mode where a decimal point is used to separate units from tenths, i.e. **20.00**; The European format uses a comma, i.e. **20,00** to separate units from tenths. To change this setting:

1. Use the ▲ button or ▼ button to select "USA" or "Euro".
2. When the desired format is set, press the ENTER button to store the setting.

ESC – Exit the Setting Mode

Press the SET or ESC Button to exit set mode.

Battery Replacement and Disposal

When the low battery icon  appears on the LCD, the batteries must be replaced. Several hours of accurate readings are still possible in this condition; however batteries should be replaced as soon as possible:

- Remove the two (2) Phillips screws and the compartment cover from the rear of the meter.
- Replace the six (6) 1.5V 'AA' batteries observing polarity.
- Replace the battery compartment cover and secure with the two (2) Phillips screws.



All EU users are legally bound by the battery ordinance to return all used batteries to collection points in your community or wherever batteries / accumulators are sold! Disposal in the household garbage is prohibited!

WARNING: Do not dispose of the batteries in a fire. Batteries can explode or leak.

WARNING: Do not mix old and new batteries. Do not mix alkaline, standard (carbon-zinc) or rechargeable (nickel-cadmium) batteries.

Specifications

	475040-SD	Resolution	475044-SD	Resolution
Range	3 to 5000g	1	0.02 to 20.00kg	0.01
	0.10 to 176.40 oz	0.02	0.07 to 44.10lb	0.01
	0.03 to 49.03N	0.01	0.3 to 196.12N	0.02
Accuracy*	± (0.4% Rdg + 1 digit)		± (0.5% Rdg + 2 digit)	
	*@3000g & 5000g and 23 ± 5 °C		*@10kg & 20kg and 23 ± 5 °C	

Display	5 digit backlit LCD 0.63" (16 mm) digit size.
Display Direction	Positive or Reverse
Unit select	g (grams), oz (ounces), N (Newtons) (475040-SD) kg (kilograms), lb (pounds), N (Newtons) (475044-SD)
Update time	Fast: Approx. 0.2 second, Slow: Approx. 0.6 second.
Over range Indicator	" - - - - "
Sampling Time	0 sec to 8 hour 59 min. 59 sec.
Peak hold Sampling Time	10ms to 500ms. in 10ms steps.
Data error no.	0.1% of total saved data max.
Memory Card	SD memory card. 1 GB to 16 GB.
Data output	RS 232/USB PC computer interface. Optional software
Overload Capacity	475040: 7kg Max, 475044: 30kg Max
Full Scale Deflection	475040: Approx. 2mm max., 475044: Approx. 0.4mm max.,
Zero/tare Control	Max. full capacity.
Transducer	load cell.
Power Supply	6 AA 1.5V alkaline batteries (UM3 or equivalent) or optional 9V AC adaptor
Power	Normal operation (no SD card), Backlight off: Approx. DC 7 mA. With SD card, backlight off: Approx. DC 38 mA With SD card, backlight on: Approx. DC 41 mA
Operating Temperature	32°F to 122°F (0°C to 50°C).
Operating Humidity	Less than 80% RH.
Dimension	8.5 x 3.5 x 1.8 inch (215 x 90 x 45 mm).
Weight	1.43 LB (650 g)/with batteries.

Copyright © 2013 FLIR Systems, Inc.

All rights reserved including the right of reproduction in whole or in part in any form

ISO-9001 Certified

www.extech.com