

Device Features

- OIP3 = 48.5dBm @ 700 MHz
- Gain = 22.0 dB @ 700 MHz
- Output P1 dB = 33dBm @ 700 MHz
- Highly Reliable InGaP/GaAs HBT Technology
- RoHS2-compliant 24L QFN 4X4 SMT package

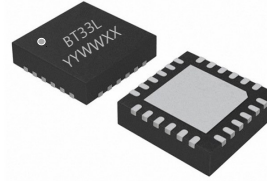

Product Description

The BT33L is a high dynamic range power amplifier housed in RoHS2 compliant 24L, 4x4mm QFN package. The BT33L uses a high reliability InGaP/GaAs HBT process technology. The BT33L is designed for use where high linearity and gain is required. The BT33L is able to deliver over 22 dBm output power from 200 to 1000MHz while maintaining superior ACLR performance with a few external matching components. All devices are 100% RF/DC screened.

Applications

- Base station /Repeaters Infrastructure
- Commercial/Industrial/Military wireless system
- LTE / WCDMA /CDMA Wireless Infrastructure
- Wireless LAN

Application Circuits

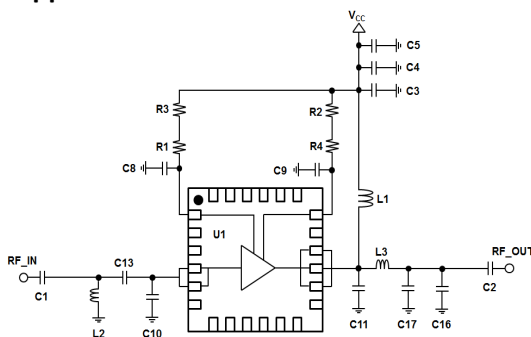

*External matching circuit: refer to the page 4 to 15.

Electrical Specifications

Device performance _ measured on a BeRex evaluation board at 25°C, Vc=5V, 50 Ω system.

Parameter	Conditions	Min	Typ	Max	Unit
Operational Frequency Range		100		1000	MHz
Test Frequency			700		MHz
Gain		20.5	22.0		dB
Input Return Loss			-12.1		dB
Output Return Loss			-7.3		dB
Output IP3	20 dBm/tone,	45.5	48.5		dBm
Output P1dB		32.0	33.0		dBm
WCDMA 4FA ACLR*		19.8	20.8		dBm
LTE20M ACLR*		21.2	22.2		dBm
Noise Figure			6.8		dB

* ACLR Channel Power measured at -50dBc.

- ACLR Test set-up: 3GPP WCDMA, TM1+64DPCH, +5MHz offset, PAR 9.78 at 0.01% Prob.

- LTE set-up: 3GPP LTE, FDD E-TM3.1, 20MHz BW, ±5MHz offset, PAR 9.75 @0.01% Prob.

Recommended Operating Conditions

Parameter	Min	Typ	Max	Unit
Bandwidth	100		1000	MHz
I _C @ (V _c = 5V)	320	400	480	mA
V _C	4.75	5.0	5.25	V
R _{TH}		10.9		°C/W
Operating Case Temperature	-40		+85	°C

Electrical specifications are measured at specified test conditions.

Specifications are not guaranteed over all recommended operating conditions.

Absolute Maximum Ratings

Parameter	Rating	Unit
Storage Temperature	-55 to +155	°C
Junction Temperature	+175	°C
Supply Voltage	+6.0	V
Supply Current	1.2	A
Input RF Power	26	dBm

*Operation of this device above any of these parameters may result in permanent damage.

Typical Performance (V_{cc} & $V_{Bias} = 5V$, $I_{cq}=400mA$, $T_a=25^\circ C$)

Parameter	Frequency				Unit
	200	540	700	900	
					MHz
Gain	25.7	23.4	22.0	21.3	dB
S11	-10.4	-10.3	-12.1	-10.2	dB
S22	-10.3	-7.5	-7.3	-10.7	dB
OIP3	43.0	47.5	48.5	47.5	dBm
P1dB	31.8	32.4	33.0	32.7	dBm
WCDMA 4FA_ACLR	17.5	20.4	20.8	21.6	dBm
LTE20M ACLR	21.4	21.8	22.2	22.0	dBm
Noise Figure	8.6	6.5	6.8	6.8	dB

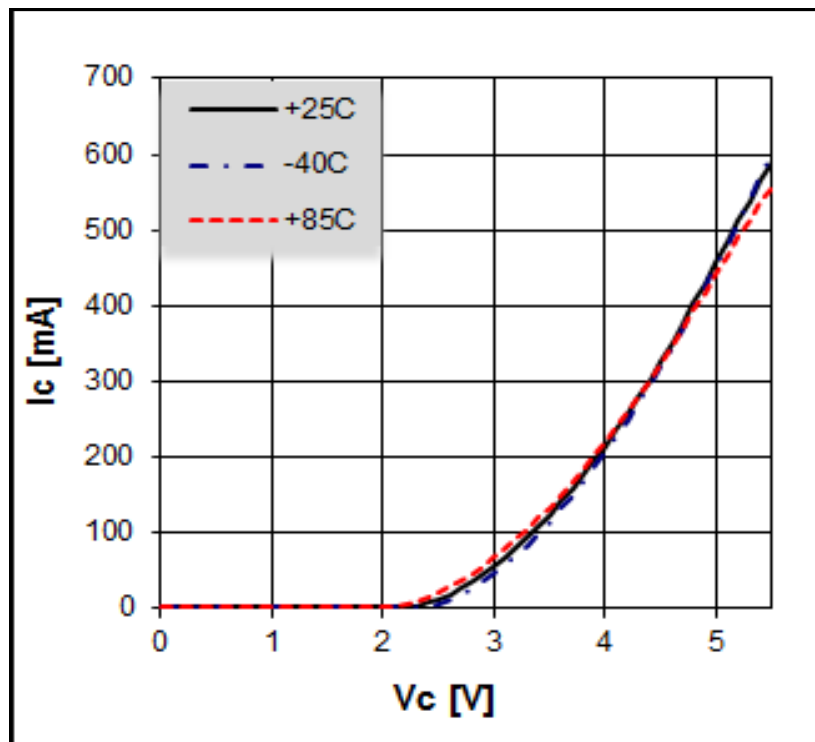
V-I Characteristics

Pin Configuration

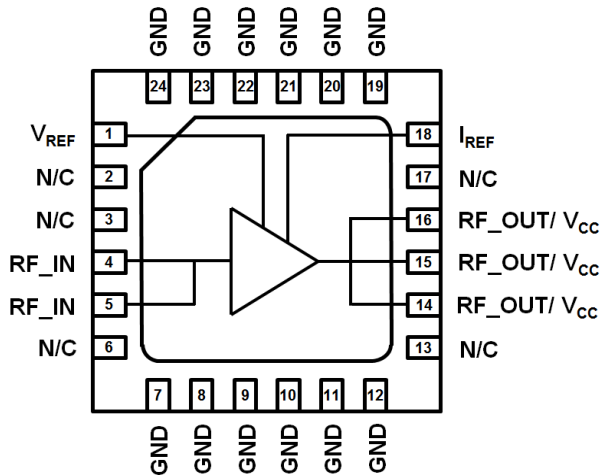

Pin No.	Label
1	V _{REF}
4,5	RF IN
14,15,16	RF OUT/V _{CC}
18	I _{REF}
2,3,6,13,17	N/C
7,8,9,10,11,12 19,20,21,22,23,24	GND
Backside Paddle	GND

BeRex Evaluation Board

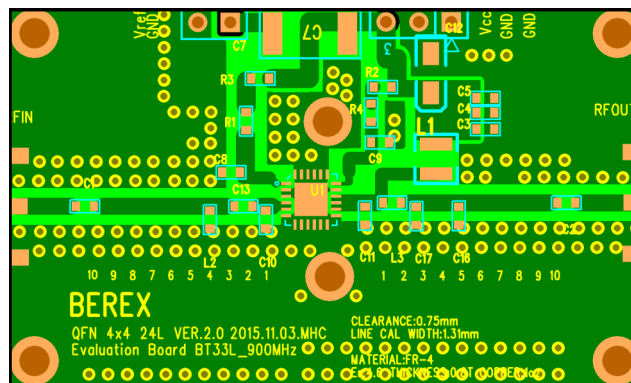

*Dielectric constant _ 4.6 *RF pattern width 52mil *31mil thick FR4 PCB

Figure about the reference position of components

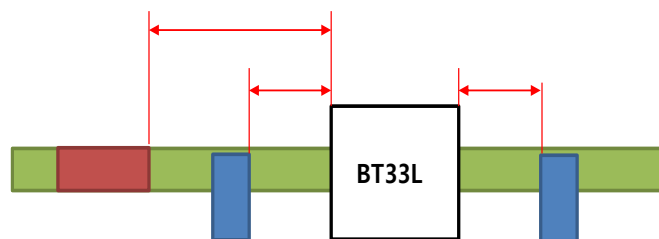

Typical Device Data

S-parameters (V_{cc} & V_{Bias} = +5V, I_{cq} = 400mA, T_a = 25°C)

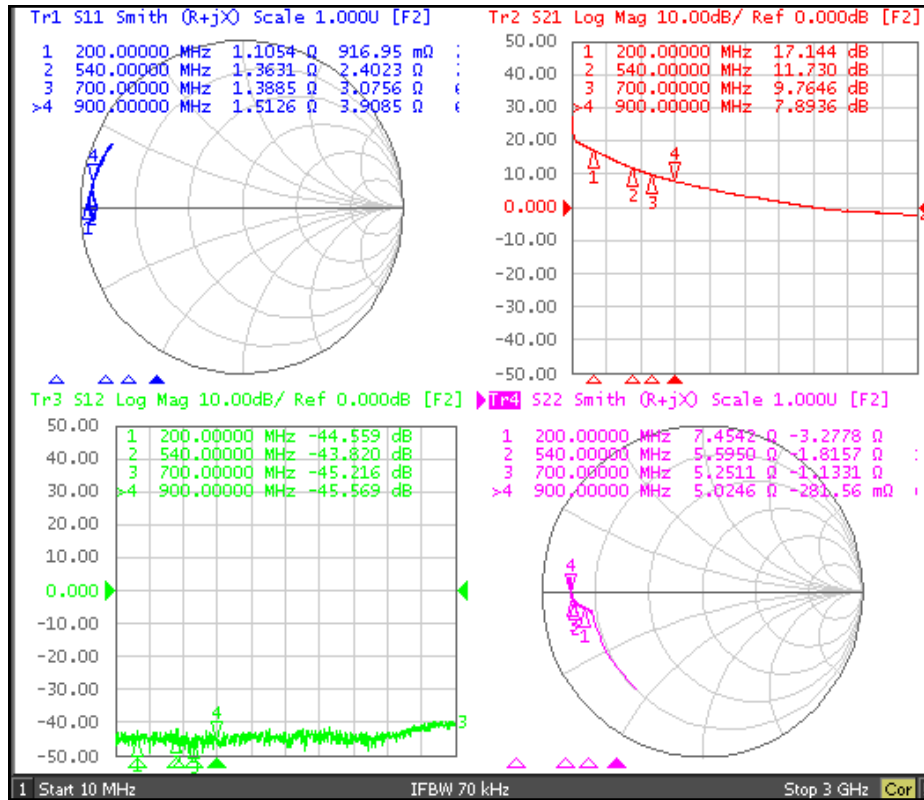

S-Parameter

(V_{cc} & V_{Bias} = 5.0V, I_{cq} = 400mA, T_a = 25 °C, calibrated to device leads)

Freq [MHz]	S11 [Mag]	S11 [Ang]	S21 [Mag]	S21 [Ang]	S12 [Mag]	S12 [Ang]	S22 [Mag]	S22 [Ang]
100	0.955743	179.2819	8.653431	145.1726	0.005675	2.16267	0.702571	-170.56
200	0.954013	177.8986	7.158374	131.9803	0.006977	1.90465	0.73797	-172.26
300	0.953118	176.9255	5.876515	120.3807	0.005183	6.429368	0.764268	-173.566
400	0.949332	175.6345	4.856165	111.2287	0.005855	11.65853	0.780491	-174.609
500	0.949661	174.7228	4.095554	104.4372	0.006112	3.893116	0.789961	-175.507
600	0.944641	173.7638	3.519923	98.68187	0.004056	-7.89958	0.79761	-176.772
700	0.944308	172.9361	3.058906	93.74037	0.005675	9.28646	0.80667	-177.469
800	0.944684	171.9397	2.715006	89.81302	0.004249	26.54267	0.810602	-178.254
900	0.942283	170.6934	2.477931	85.89291	0.006281	17.07312	0.812659	-179.449
1000	0.938657	169.7818	2.244615	82.23878	0.005576	20.27439	0.810386	179.6869

Application Circuit: 200 MHz

Schematic Diagram		BOM		Marks
	C1	0603	100pF	Samsung
	C2	0603	100pF	Samsung
	C3	0603	22pF	Samsung
	C4	0603	1000pF	Samsung
	C5	0603	1 uF	Samsung
	C6	0603	39pF	Samsung
	C7	0603	N/C	-
	C8	0603	N/C	-
	C9	0603	N/C	-
	C10	0603	N/C	-
	C11	0603	27pF	Samsung
	C12	0603	N/C	-
	C16	0603	N/C	-
	C17	0603	33pF	Samsung
	L1	1008	56nH	Coilcraft
	L2	0603	12nH	Taiyo Yuden
	L3	0603	15nH	Taiyo Yuden
R1	0603	51Ω	Samsung	
R2	0603	91Ω	Samsung	
R3	0603	0Ω	Samsung	
R4	0603	0Ω	Samsung	
U1	4x4	BT33L	BEREX	

PCB Diagram	Notice																		
	Below information is subject to change as conditions of the substrate.																		
	<table border="1"> <thead> <tr> <th>Reference</th> <th>Object</th> <th>Distance</th> </tr> </thead> <tbody> <tr> <td>Input pin</td> <td>C6</td> <td>5.5mm</td> </tr> <tr> <td>Input pin</td> <td>L2</td> <td>2.5mm</td> </tr> <tr> <td>Output pin</td> <td>C11</td> <td>2.0mm</td> </tr> <tr> <td>Output pin</td> <td>L3</td> <td>3.4mm</td> </tr> <tr> <td>Output pin</td> <td>C17</td> <td>5.7mm</td> </tr> </tbody> </table>	Reference	Object	Distance	Input pin	C6	5.5mm	Input pin	L2	2.5mm	Output pin	C11	2.0mm	Output pin	L3	3.4mm	Output pin	C17	5.7mm
	Reference	Object	Distance																
	Input pin	C6	5.5mm																
	Input pin	L2	2.5mm																
Output pin	C11	2.0mm																	
Output pin	L3	3.4mm																	
Output pin	C17	5.7mm																	
<p>BEREX QFN 4x4 24L VER.2.0 2015.11.03.MHC Evaluation Board BT33L_200MHz</p> <p>CLEARANCE:0.75mm LINE CAL WIDTH:1.31mm MATERIAL:FR-4 Etching Thickness:0.075mm</p>																			

Typical Performance

(V_{cc} & V_{Bias} = +5V, I_{cQ} = 400mA, T_a = 25°C)

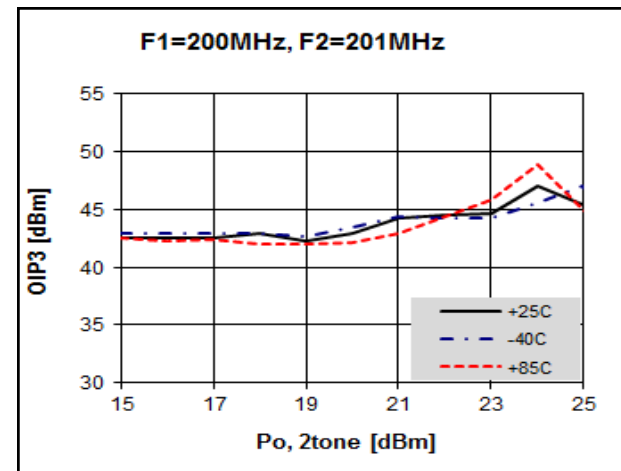
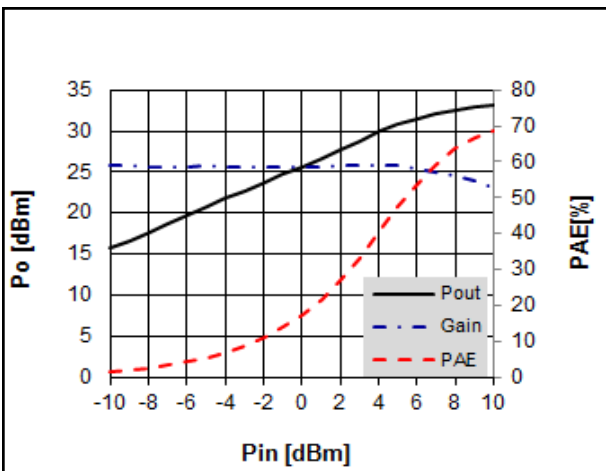
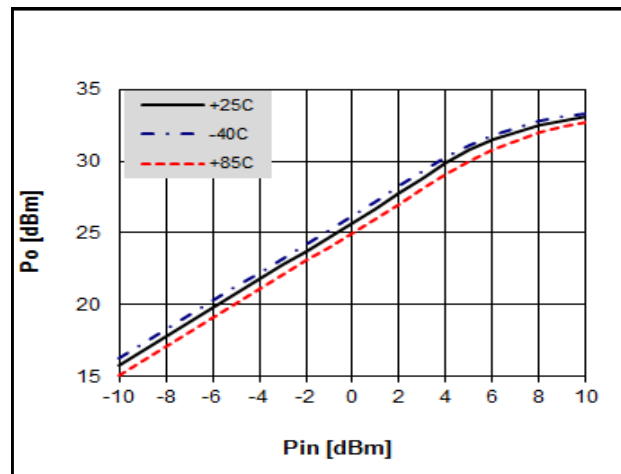
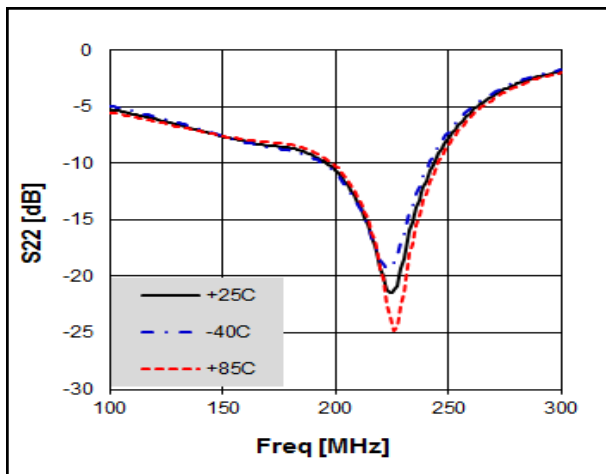
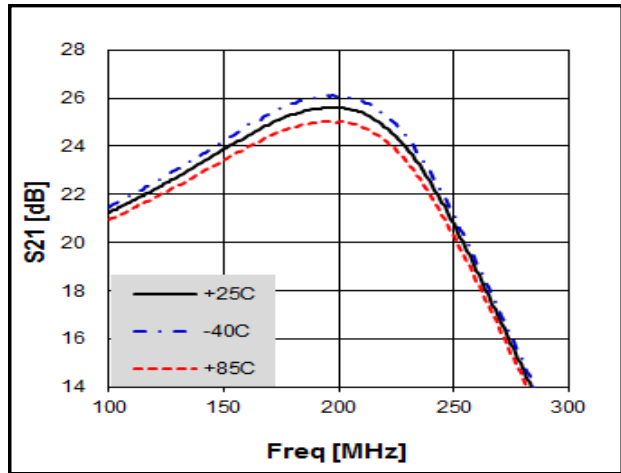
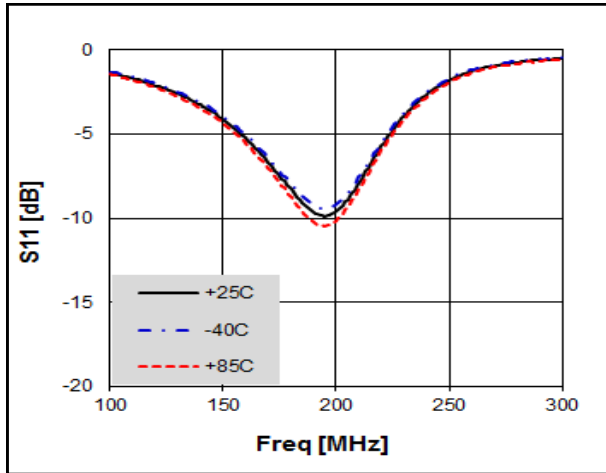

100-1000MHz 1.5W ~ 2.0W High Linearity 5V Power Amplifier

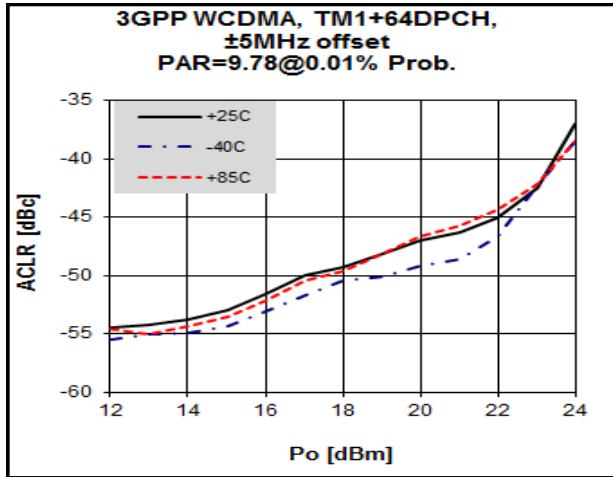

3GPP WCDMA TM1 +64DPCH 4FA

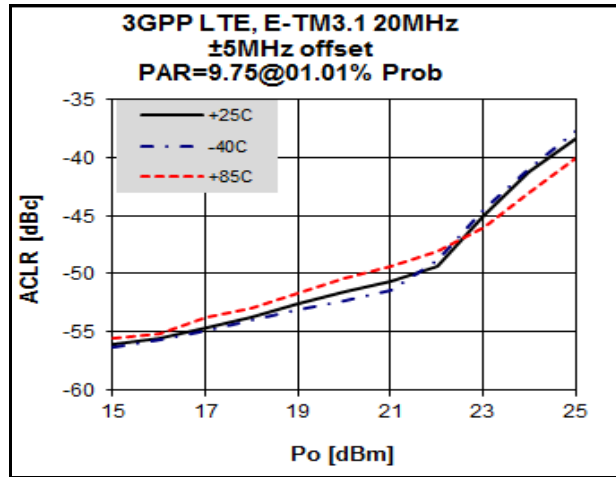

3GPP LTE E-TM3.1 20MHz

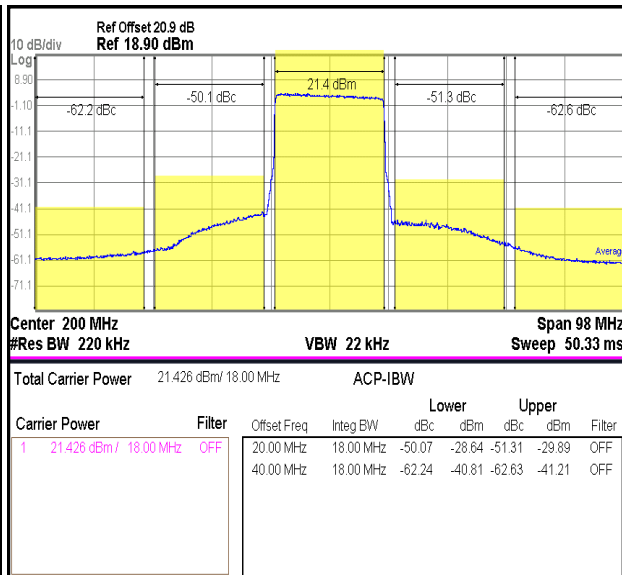
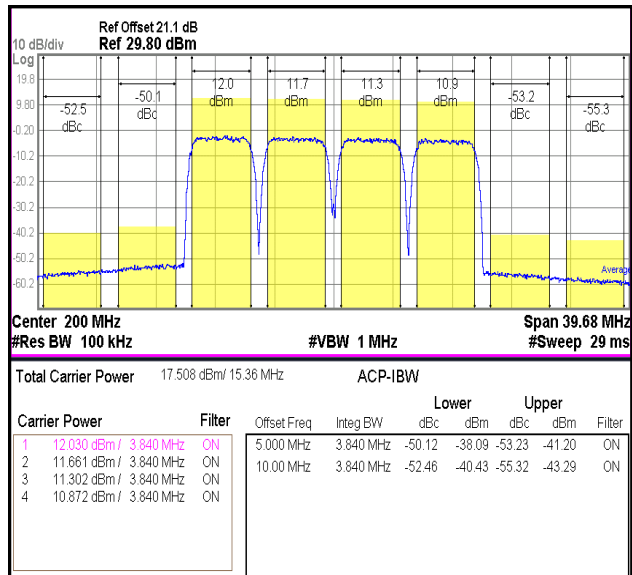

Application Circuit: 540 MHz

Schematic Diagram	BOM	Marks																																																																				
	<table border="1"> <tr><td>C1</td><td>0603</td><td>56pF</td><td>Samsung</td></tr> <tr><td>C2</td><td>0603</td><td>56pF</td><td>Samsung</td></tr> <tr><td>C3</td><td>0603</td><td>22pF</td><td>Samsung</td></tr> <tr><td>C4</td><td>0603</td><td>1000pF</td><td>Samsung</td></tr> <tr><td>C5</td><td>0603</td><td>1 uF</td><td>Samsung</td></tr> <tr><td>C7</td><td>0603</td><td>N/C</td><td>-</td></tr> <tr><td>C8</td><td>0603</td><td>N/C</td><td>-</td></tr> <tr><td>C9</td><td>0603</td><td>33pF</td><td>Samsung</td></tr> <tr><td>C10</td><td>0603</td><td>30pF</td><td>Samsung</td></tr> <tr><td>C11</td><td>0603</td><td>12pF</td><td>Samsung</td></tr> <tr><td>C12</td><td>0603</td><td>N/C</td><td>-</td></tr> <tr><td>C13</td><td>0603</td><td>10pF</td><td>Samsung</td></tr> <tr><td>C16</td><td>0603</td><td>N/C</td><td>-</td></tr> <tr><td>C17</td><td>0603</td><td>12pF</td><td>Samsung</td></tr> </table>	C1	0603	56pF	Samsung	C2	0603	56pF	Samsung	C3	0603	22pF	Samsung	C4	0603	1000pF	Samsung	C5	0603	1 uF	Samsung	C7	0603	N/C	-	C8	0603	N/C	-	C9	0603	33pF	Samsung	C10	0603	30pF	Samsung	C11	0603	12pF	Samsung	C12	0603	N/C	-	C13	0603	10pF	Samsung	C16	0603	N/C	-	C17	0603	12pF	Samsung	<table border="1"> <tr><td>L1</td><td>1008</td><td>56nH</td><td>Coilcraft</td></tr> <tr><td>L2</td><td>0603</td><td>8.2nH</td><td>Taiyo Yuden</td></tr> <tr><td>L3</td><td>0603</td><td>3.9nH</td><td>Taiyo Yuden</td></tr> </table>	L1	1008	56nH	Coilcraft	L2	0603	8.2nH	Taiyo Yuden	L3	0603	3.9nH	Taiyo Yuden
	C1	0603	56pF	Samsung																																																																		
	C2	0603	56pF	Samsung																																																																		
	C3	0603	22pF	Samsung																																																																		
	C4	0603	1000pF	Samsung																																																																		
	C5	0603	1 uF	Samsung																																																																		
	C7	0603	N/C	-																																																																		
	C8	0603	N/C	-																																																																		
	C9	0603	33pF	Samsung																																																																		
	C10	0603	30pF	Samsung																																																																		
	C11	0603	12pF	Samsung																																																																		
	C12	0603	N/C	-																																																																		
	C13	0603	10pF	Samsung																																																																		
	C16	0603	N/C	-																																																																		
	C17	0603	12pF	Samsung																																																																		
	L1	1008	56nH	Coilcraft																																																																		
	L2	0603	8.2nH	Taiyo Yuden																																																																		
L3	0603	3.9nH	Taiyo Yuden																																																																			
	<table border="1"> <tr><td>R1</td><td>0603</td><td>51Ω</td><td>Samsung</td></tr> <tr><td>R2</td><td>0603</td><td>91Ω</td><td>Samsung</td></tr> <tr><td>R3</td><td>0603</td><td>0Ω</td><td>Samsung</td></tr> <tr><td>R4</td><td>0603</td><td>0Ω</td><td>Samsung</td></tr> </table>	R1	0603	51Ω	Samsung	R2	0603	91Ω	Samsung	R3	0603	0Ω	Samsung	R4	0603	0Ω	Samsung	<table border="1"> <tr><td>U1</td><td>4x4</td><td>BT33L</td><td>BEREX</td></tr> </table>	U1	4x4	BT33L	BEREX																																																
R1	0603	51Ω	Samsung																																																																			
R2	0603	91Ω	Samsung																																																																			
R3	0603	0Ω	Samsung																																																																			
R4	0603	0Ω	Samsung																																																																			
U1	4x4	BT33L	BEREX																																																																			

PCB Diagram	Notice																					
	<p>Below information is subject to change as conditions of the substrate.</p> <table border="1"> <thead> <tr> <th>Reference</th> <th>Object</th> <th>Distance</th> </tr> </thead> <tbody> <tr><td>Input pin</td><td>L2</td><td>5.5mm</td></tr> <tr><td>Input pin</td><td>C13</td><td>2.5mm</td></tr> <tr><td>Input pin</td><td>C10</td><td>1.3mm</td></tr> <tr><td>Output pin</td><td>C11</td><td>1.8mm</td></tr> <tr><td>Output pin</td><td>L3</td><td>3.4mm</td></tr> <tr><td>Output pin</td><td>C17</td><td>7.0mm</td></tr> </tbody> </table>	Reference	Object	Distance	Input pin	L2	5.5mm	Input pin	C13	2.5mm	Input pin	C10	1.3mm	Output pin	C11	1.8mm	Output pin	L3	3.4mm	Output pin	C17	7.0mm
	Reference	Object	Distance																			
Input pin	L2	5.5mm																				
Input pin	C13	2.5mm																				
Input pin	C10	1.3mm																				
Output pin	C11	1.8mm																				
Output pin	L3	3.4mm																				
Output pin	C17	7.0mm																				
<p>BEREX QFN 4x4 24L VER.2.0 2015.11.03.MHC Evaluation Board BT33L_540MHz</p> <p>CLEARANCE:0.75mm LINE CAL WIDTH:1.31mm MATERIAL:FR-4 Etching Thickness:0.0130±0.001mm</p>																						

Typical Performance

(V_{cc} & V_{Bias} = +5V, I_{cq} = 400mA, T_a = 25°C)

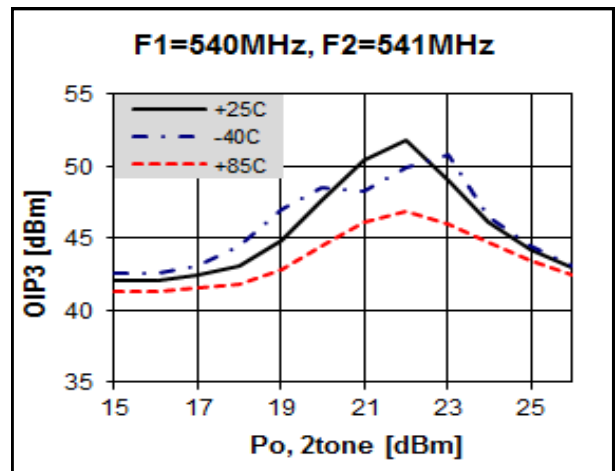
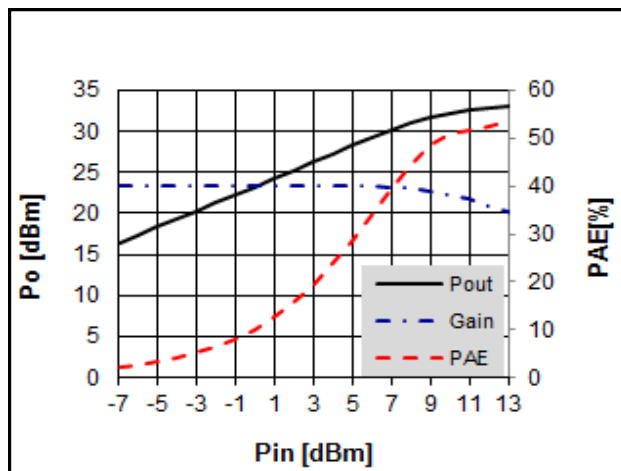
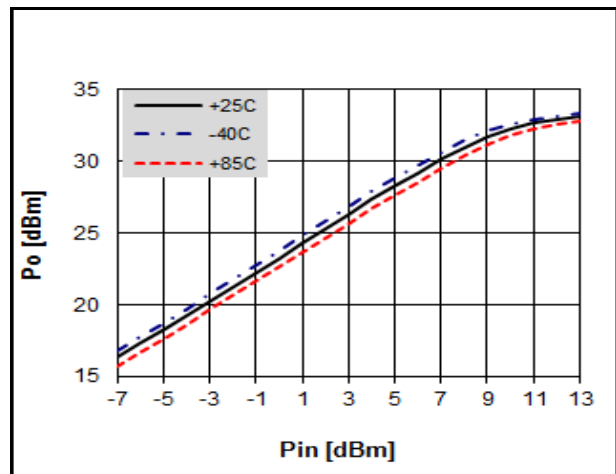
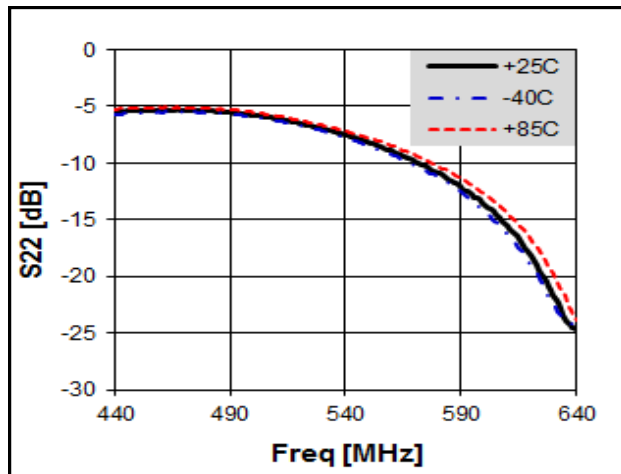
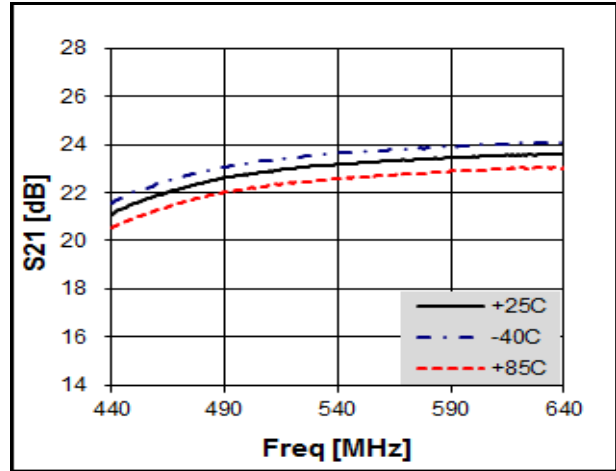
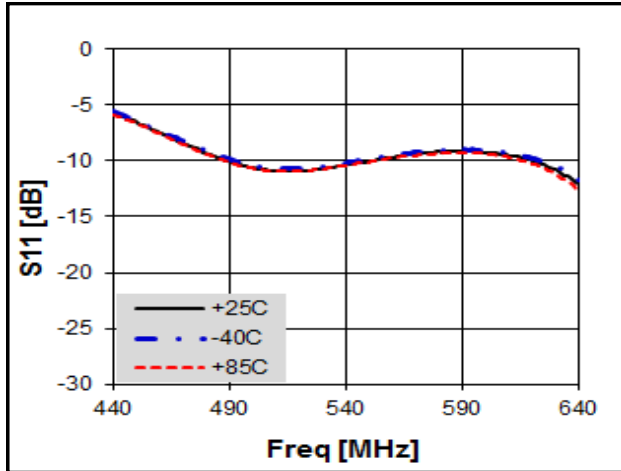

100-1000MHz 1.5W ~ 2.0W High Linearity 5V Power Amplifier

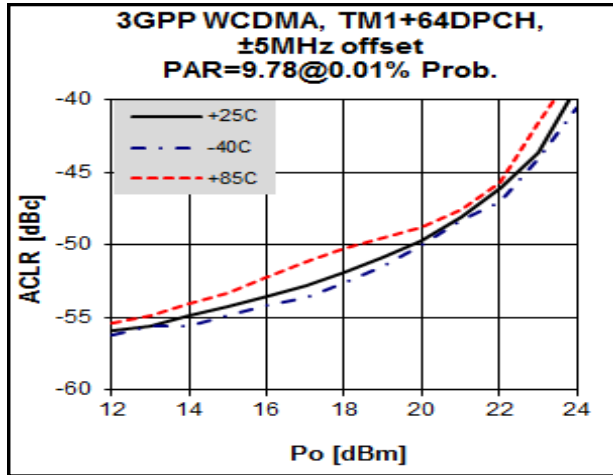

3GPP WCDMA TM1 +64DPCH 4FA

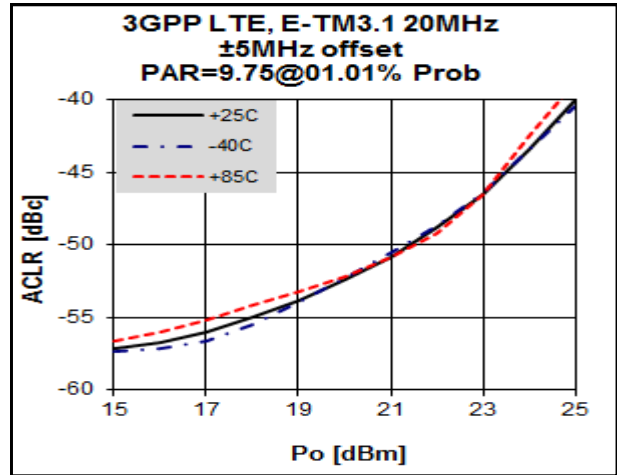

3GPP LTE E-TM3.1 20MHz

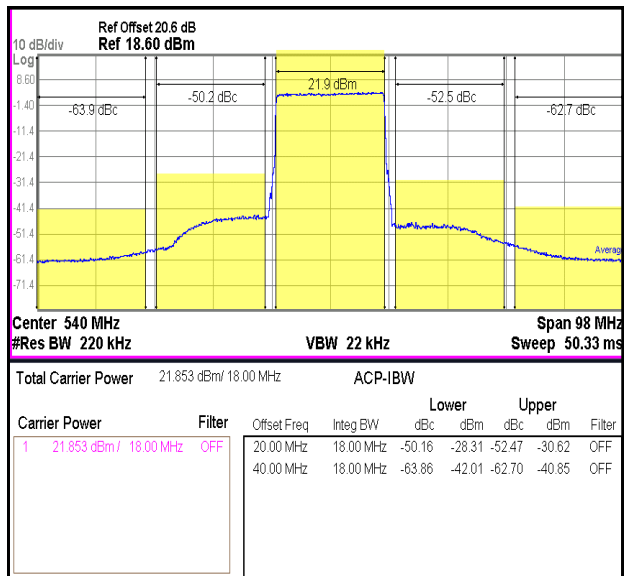
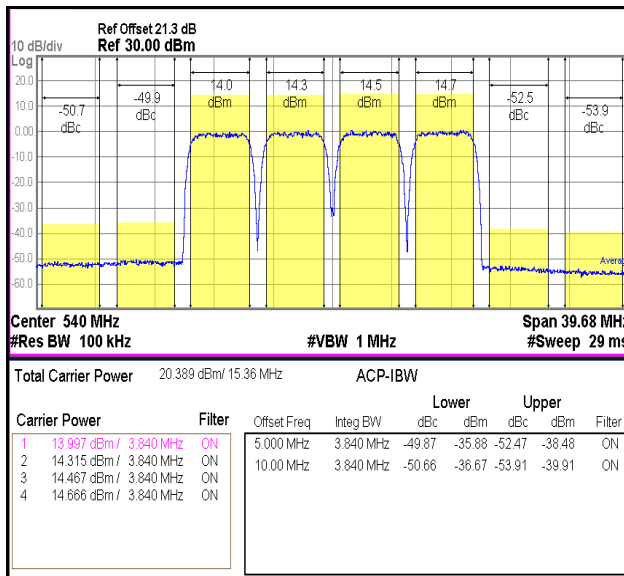

Application Circuit: 700 MHz

Schematic Diagram		BOM		Marks	
		C1	0603	56pF	Samsung
		C2	0603	56pF	Samsung
		C3	0603	22pF	Samsung
		C4	0603	1000pF	Samsung
		C5	0603	1 uF	Samsung
		C7	0603	N/C	-
		C8	0603	2pF	Samsung
		C9	0603	33pF	Samsung
		C10	0603	22pF	Samsung
		C11	0603	9pF	Samsung
		C12	0603	N/C	-
		C13	0603	8pF	Samsung
		C16	0603	9pF	Samsung
		C17	0603	N/C	-
		L1	1008	47nH	Coilcraft
		L2	0603	6.8nH	Taiyo Yuden
		L3	0603	1.5nH	Taiyo Yuden
R1	0603	51Ω	Samsung		
R2	0603	91Ω	Samsung		
R3	0603	0Ω	Samsung		
R4	0603	0Ω	Samsung		
U1	4x4	BT33L	BEREX		

PCB Diagram	Notice																					
	Below information is subject to change as conditions of the substrate.																					
	<table border="1"> <thead> <tr> <th>Reference</th> <th>Object</th> <th>Distance</th> </tr> </thead> <tbody> <tr> <td>Input pin</td> <td>L2</td> <td>5.0mm</td> </tr> <tr> <td>Input pin</td> <td>C13</td> <td>2.5mm</td> </tr> <tr> <td>Input pin</td> <td>C10</td> <td>1.0mm</td> </tr> <tr> <td>Output pin</td> <td>C11</td> <td>2.5mm</td> </tr> <tr> <td>Output pin</td> <td>L3</td> <td>3.3mm</td> </tr> <tr> <td>Output pin</td> <td>C16</td> <td>8.3mm</td> </tr> </tbody> </table>	Reference	Object	Distance	Input pin	L2	5.0mm	Input pin	C13	2.5mm	Input pin	C10	1.0mm	Output pin	C11	2.5mm	Output pin	L3	3.3mm	Output pin	C16	8.3mm
	Reference	Object	Distance																			
	Input pin	L2	5.0mm																			
	Input pin	C13	2.5mm																			
	Input pin	C10	1.0mm																			
Output pin	C11	2.5mm																				
Output pin	L3	3.3mm																				
Output pin	C16	8.3mm																				
<p>BEREX QFN 4x4 24L VER.2.0 2015.11.03.MHC Evaluation Board BT33L_700MHz</p> <p>CLEARANCE:0.75mm LINE CAL WIDTH:1.31mm MATERIAL:FR-4 En. of Thick ES-0 T 00°C to</p>																						

Typical Performance

(V_{cc} & V_{Bias} = +5V, I_{cq} = 400mA, T_a = 25°C)

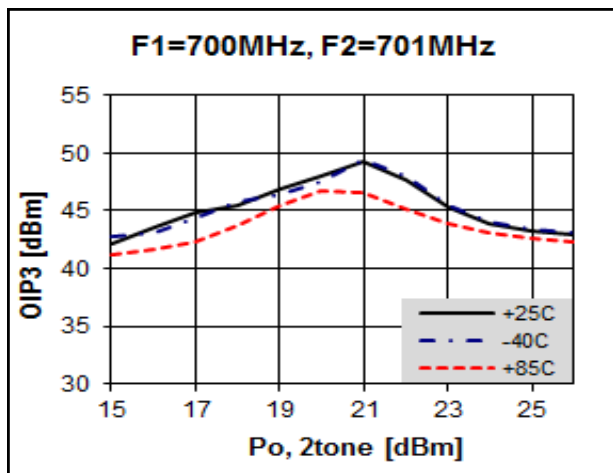
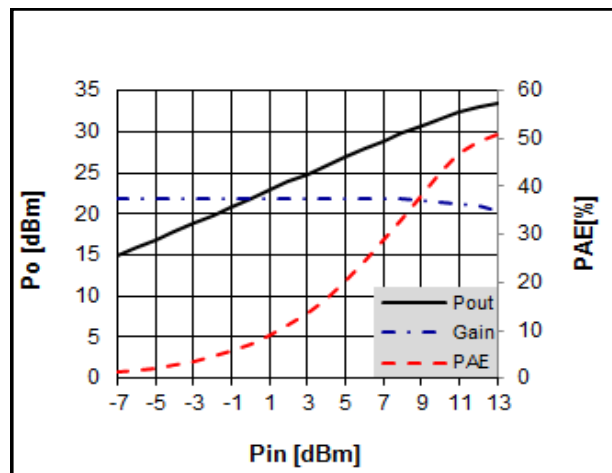
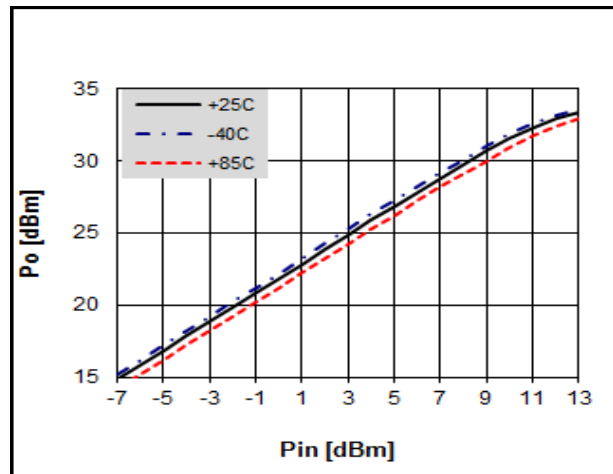
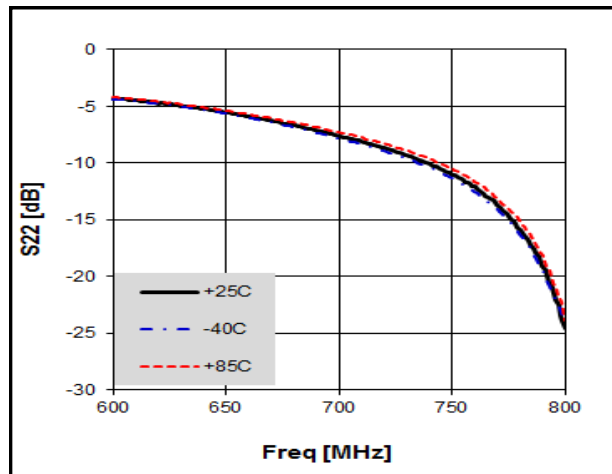
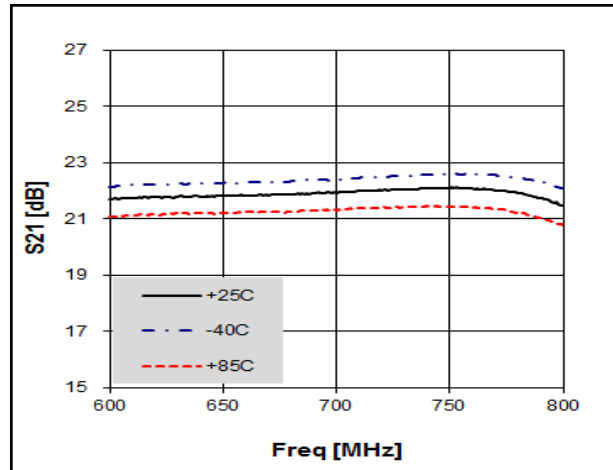
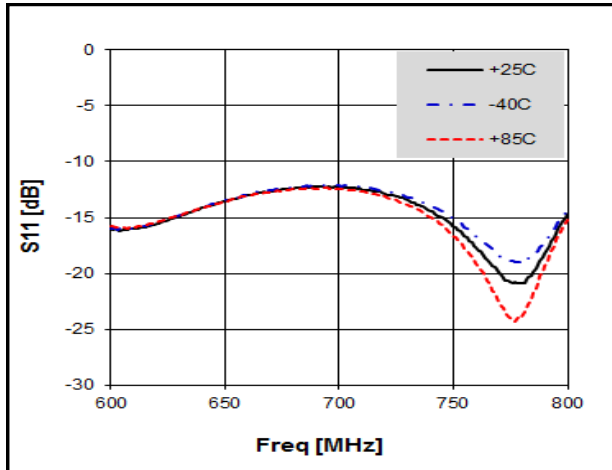

100-1000MHz 1.5W ~ 2.0W High Linearity 5V Power Amplifier

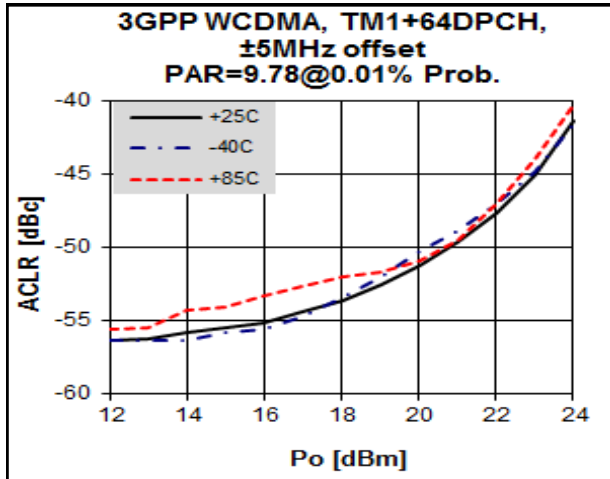

3GPP WCDMA TM1 +64DPCH 4FA

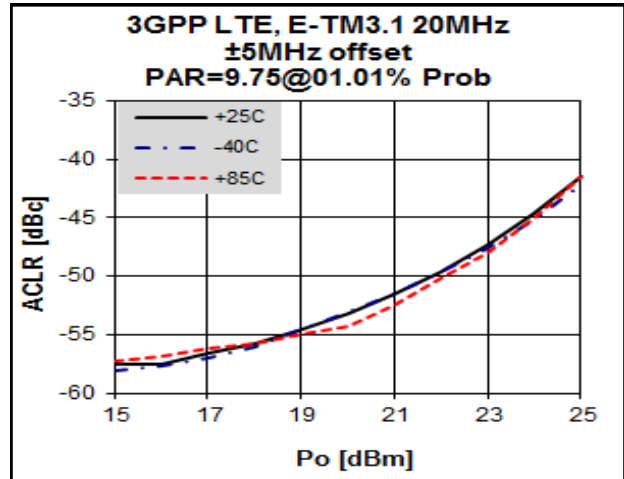

3GPP LTE E-TM3.1 20MHz

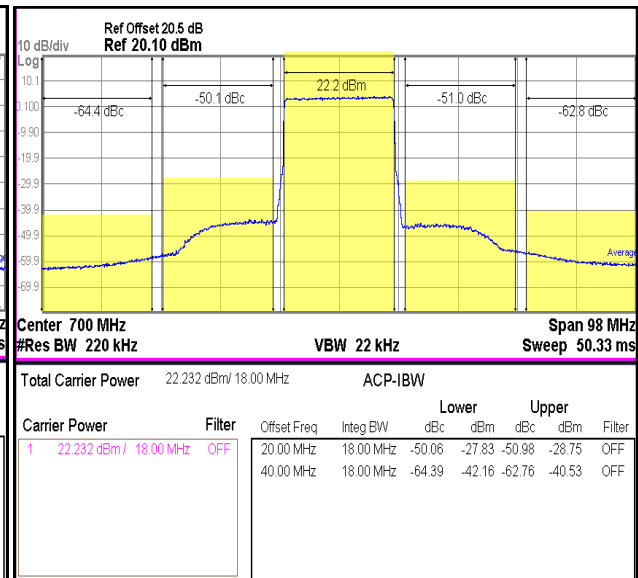
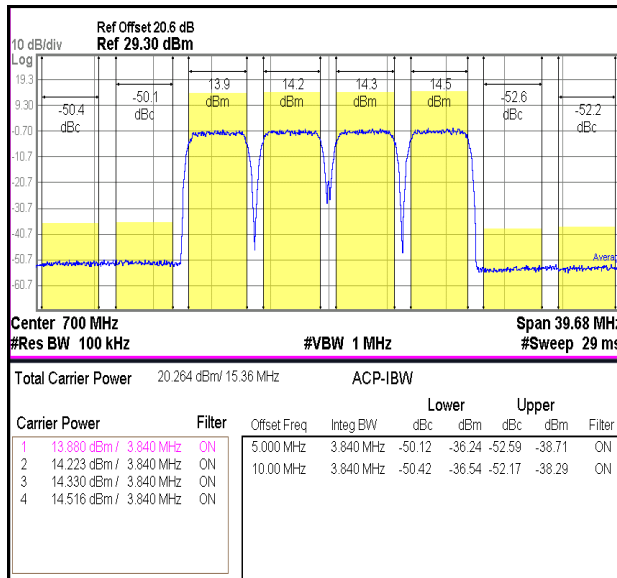

Application Circuit: 900 MHz

Schematic Diagram		BOM		Marks
	C1	0603	47pF	Samsung
	C2	0603	47pF	Samsung
	C3	0603	22pF	Samsung
	C4	0603	1000pF	Samsung
	C5	0603	1 uF	Samsung
	C7	0603	N/C	-
	C8	0603	N/C	-
	C9	0603	33pF	Samsung
	C10	0603	10pF	Samsung
	C11	0603	N/C	-
	C12	0603	N/C	-
	C13	0603	3.9pF	Samsung
	C16	0603	N/C	-
	C17	0603	8.2pF	Samsung
	L1	1008	39nH	Coilcraft
	L2	0603	5.6nH	Taiyo Yuden
	L3	0603	1.2nH	Taiyo Yuden
R1	0603	51Ω	Samsung	
R2	0603	91Ω	Samsung	
R3	0603	0Ω	Samsung	
R4	0603	0Ω	Samsung	
U1	4x4	BT33L	BEREX	

PCB Diagram	Notice																		
<p>BEREX QFN 4x4 24L VER.2.0 2015.11.03.MHC Evaluation Board BT33L_900MHz</p> <p>CLEARANCE:0.75mm LINE CAL WIDTH:1.31mm MATERIAL:FR-4 Etching:ES-0.01T 0.01PE1c</p>	<p>Below information is subject to change as conditions of the substrate.</p> <table border="1"> <thead> <tr> <th>Reference</th> <th>Object</th> <th>Distance</th> </tr> </thead> <tbody> <tr> <td>Input pin</td> <td>L2</td> <td>5.5mm</td> </tr> <tr> <td>Input pin</td> <td>C13</td> <td>2.5mm</td> </tr> <tr> <td>Input pin</td> <td>C10</td> <td>1.3mm</td> </tr> <tr> <td>Output pin</td> <td>L3</td> <td>3.3mm</td> </tr> <tr> <td>Output pin</td> <td>C17</td> <td>5.6mm</td> </tr> </tbody> </table>	Reference	Object	Distance	Input pin	L2	5.5mm	Input pin	C13	2.5mm	Input pin	C10	1.3mm	Output pin	L3	3.3mm	Output pin	C17	5.6mm
	Reference	Object	Distance																
	Input pin	L2	5.5mm																
	Input pin	C13	2.5mm																
	Input pin	C10	1.3mm																
Output pin	L3	3.3mm																	
Output pin	C17	5.6mm																	

Typical Performance

(V_{CC} & V_{Bias} = +5V, I_{CQ} = 400mA, T_a = 25°C)

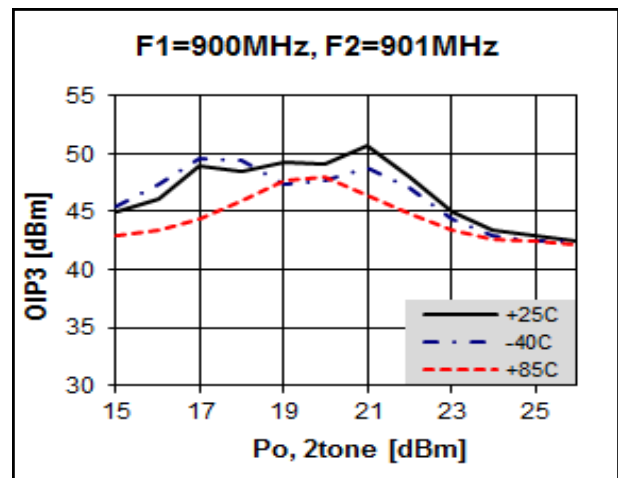
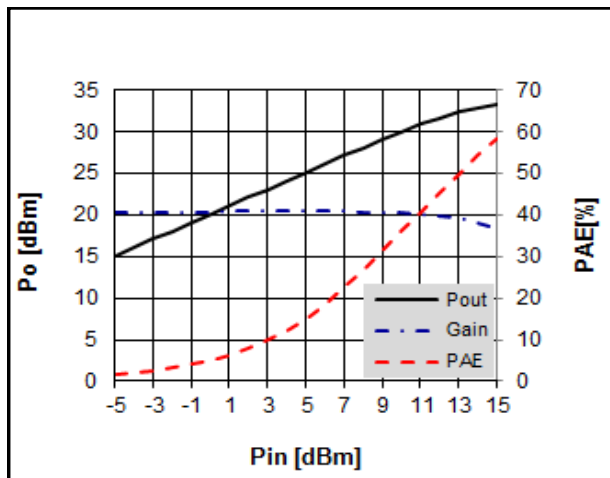
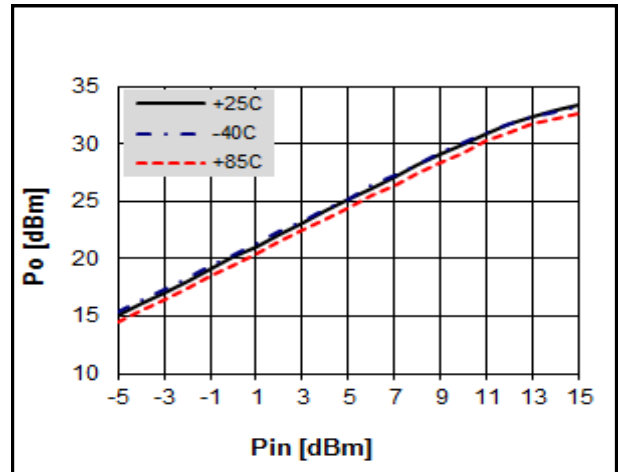
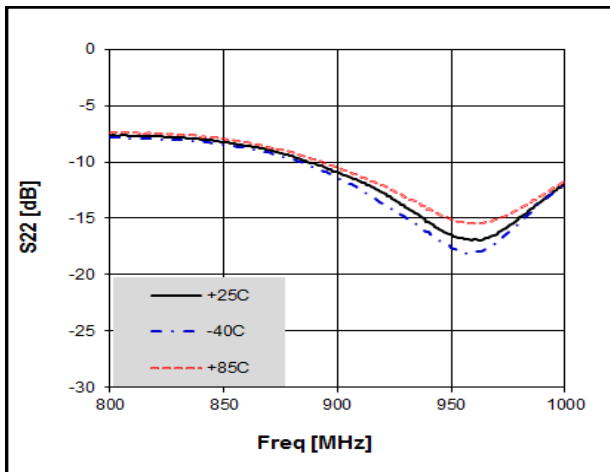
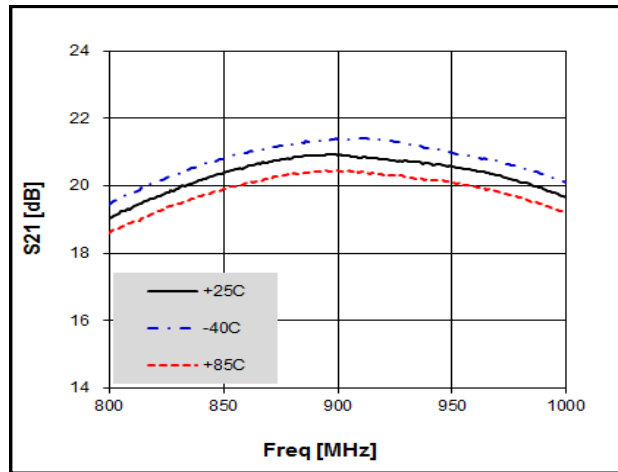
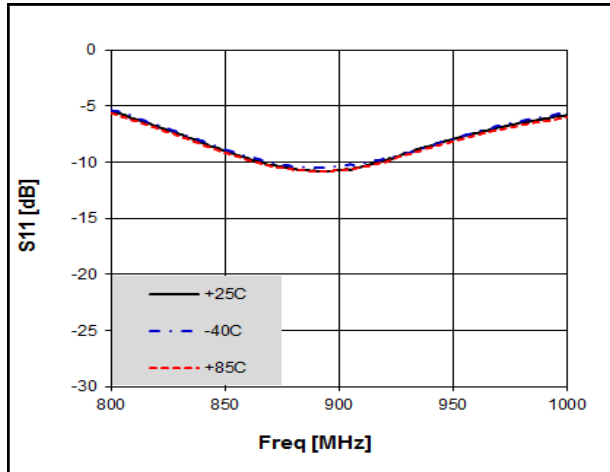

100-1000MHz 1.5W ~ 2.0W High Linearity 5V Power Amplifier

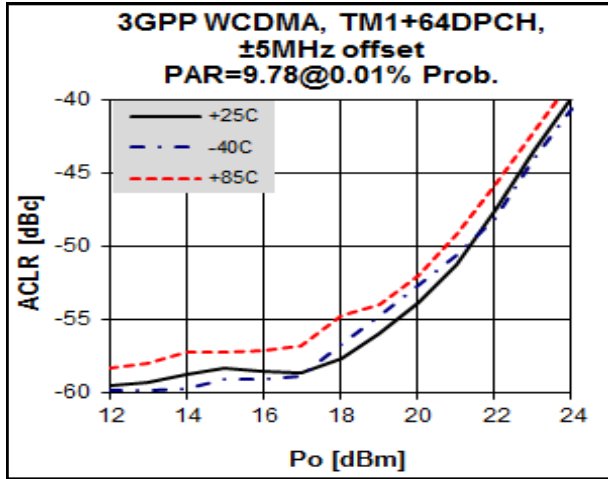

3GPP WCDMA TM1 +64DPCH 4FA

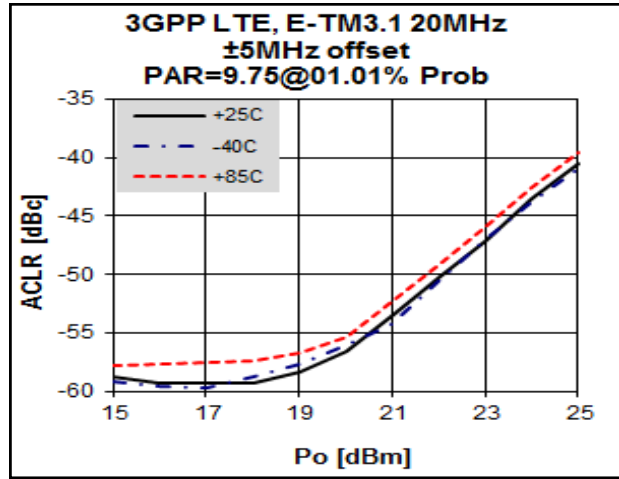

3GPP LTE E-TM3.1 20MHz

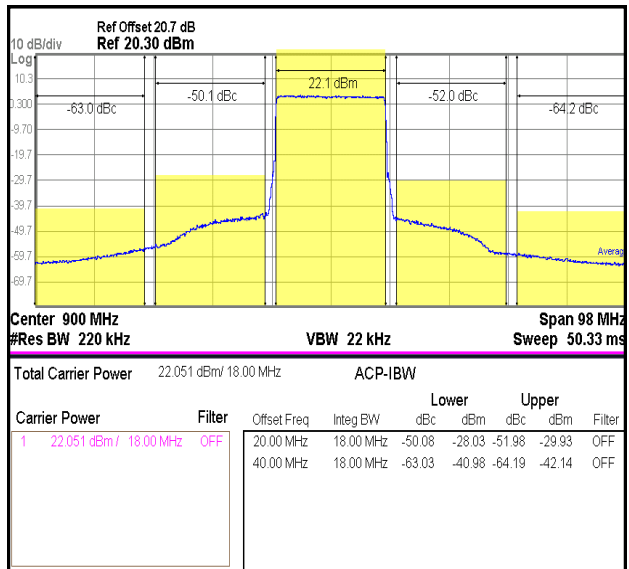
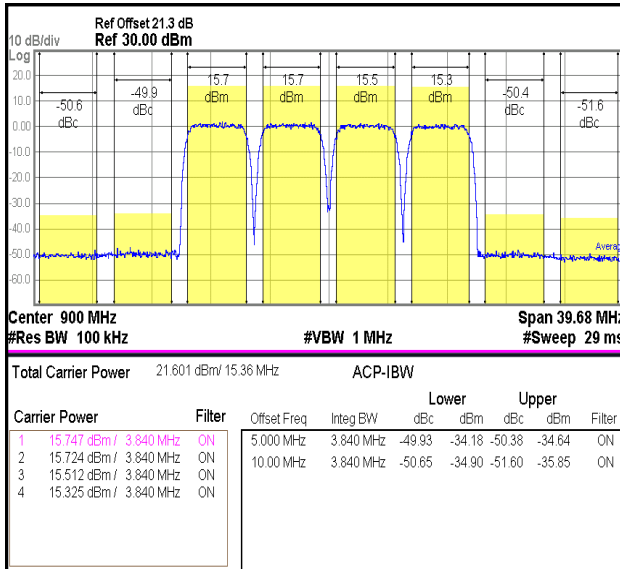

Typical Performance (Pout vs Icc)

(V_{CC} & V_{Bias} = +5V, I_{CQ} = 400mA, T_a = 25°C)

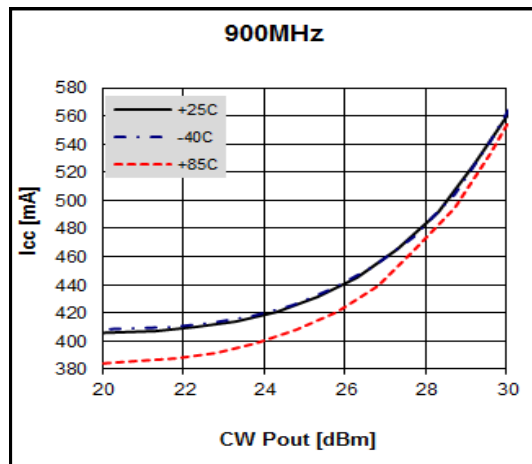
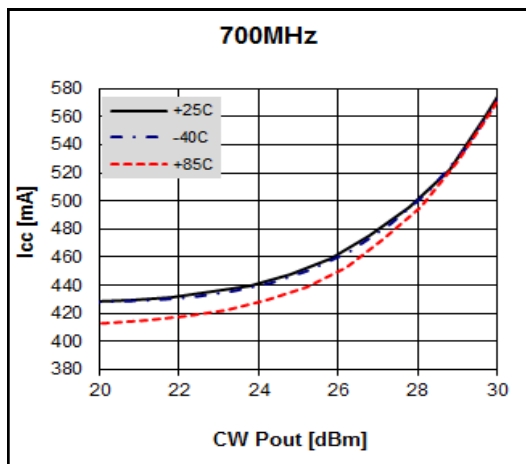
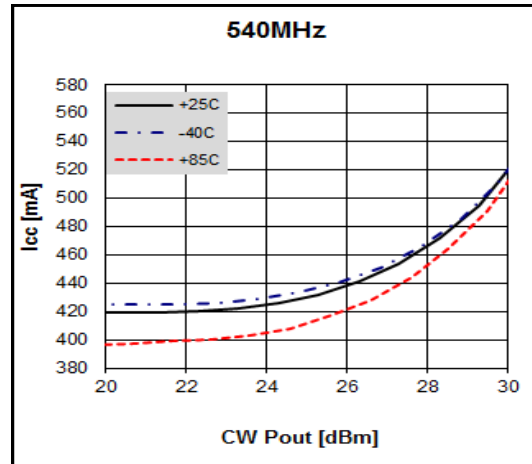
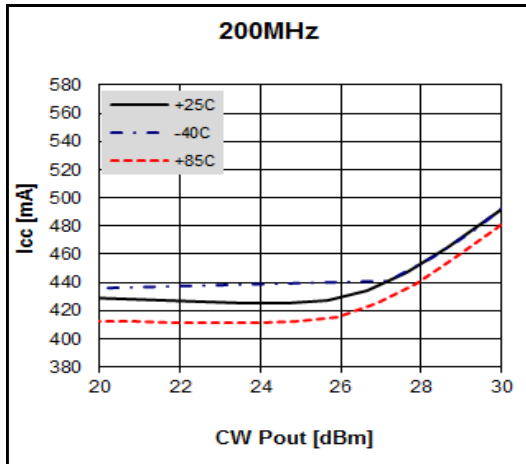

Package Outline Dimension

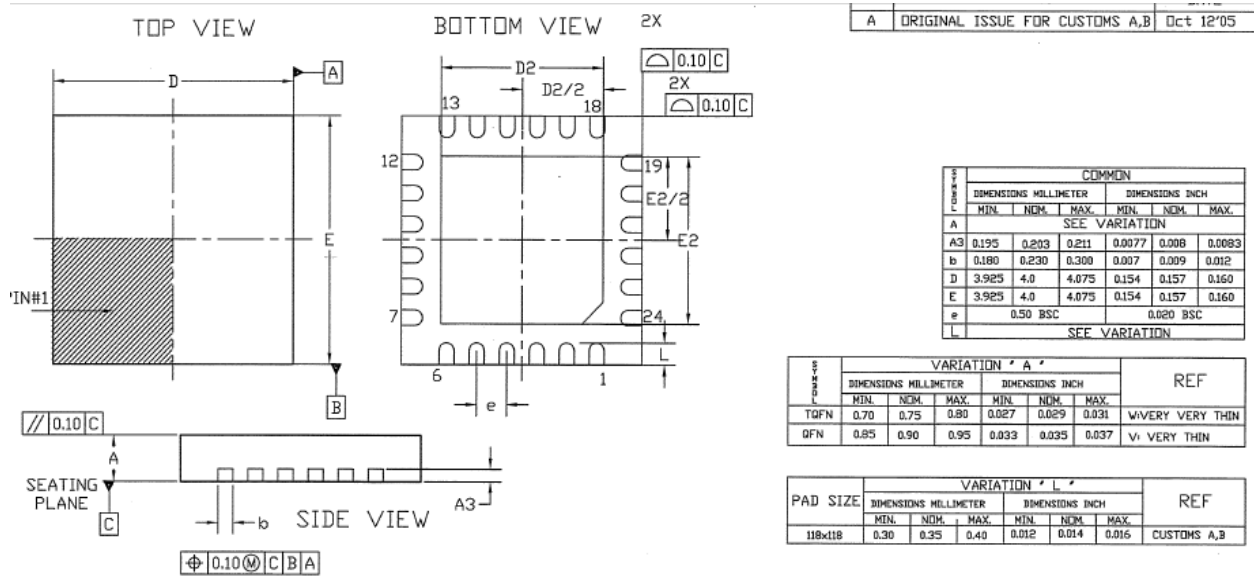

NOTES :

1. DIMENSION AND TOLERANCING CONFORM TO ASME Y14.5M-1994.
2. CONTROLLING DIMENSIONS : MILLIMETER. CONVERTED INCH DIMENSION ARE NOT NECESSARILY EXACT.
3. DIMENSION b APPLIES TO METALLIZED TERMINAL AND IS MEASURED BETWEEN 0.15 AND 0.30 MM. FROM TERMINAL TIP.

Suggested PCB Land Pattern and PAD Layout

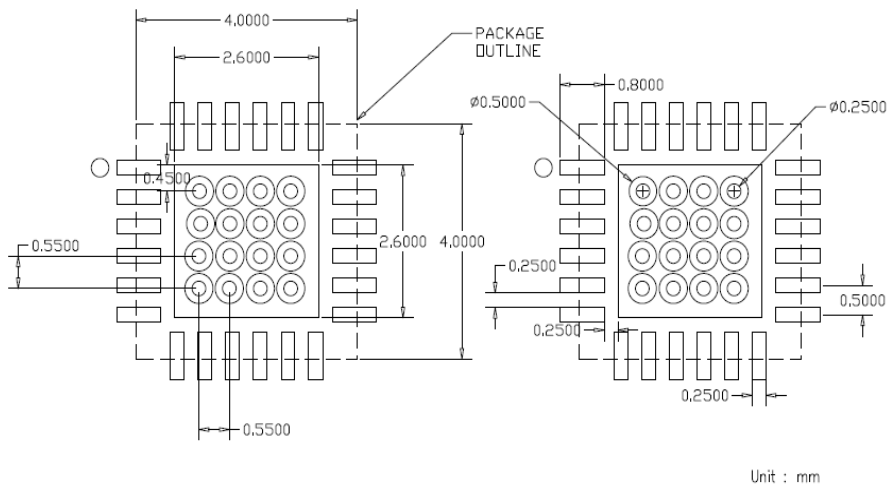

Package Marking

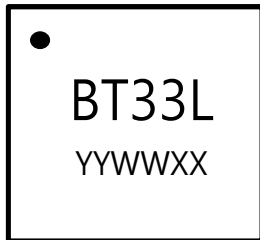

YY = Year, WW = Working Week,
XX = Wafer No.

PCB Mounting

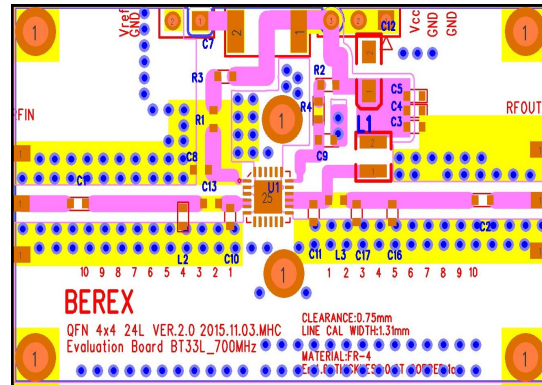

Tape & Reel

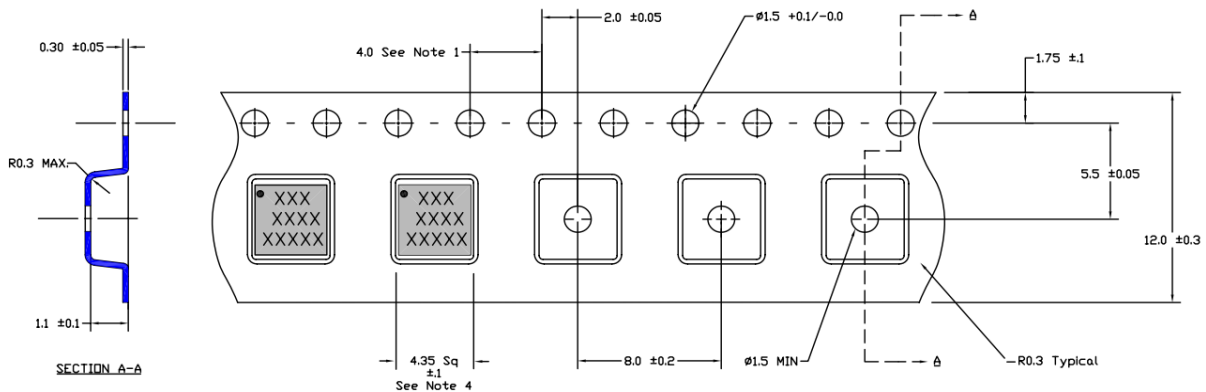

Packaging information:

Tape Width (mm): 12 / Reel Size (inches): 7

Device Cavity Pitch (mm): 8 / Devices Per Reel: 1000

Lead plating finish

100% Tin Matte finish

(All BeRex products undergoes a 1 hour, 150 degree C, Anneal bake to eliminate thin whisker growth concerns.)

MSL / ESD Rating

ESD Rating: Class 1C
Value: Passes $\geq 1000V$ to $< 2000 V$
Test: Human Body Model (HBM)
Standard: JEDEC Standard JS-001-2012

ESD Rating: Class C3
Value: Passes $>1000V$
Test: Charged Device Model (CDM)
Standard: JEDEC Standard JESD22-C101F

MSL Rating: Level 1 at $+260^{\circ}C$ convection reflow
Standard: JEDEC Standard J-STD-020



Proper ESD procedures should be followed when handling this device.

RoHS Compliance

This part is compliant with Restrictions on the Use of Certain Hazardous Substances in Electrical and Electronic Equipment (RoHS) Directive 2011/65/EU as amended by Directive 2015/863/EU.

This product also is compliant with a concentration of the Substances of Very High Concern (SVHC) candidate list which are contained in a quantity of less than 0.1%(w/w) in each components of a product and/or its packaging placed on the European Community market by the BeRex and Suppliers.

NATO CAGE code:

2	N	9	6	F
---	---	---	---	---