

Features

Power Module

- Non-isolated buck/boost converter
- Up to 3000W in half brick case
- Adjustable output voltage and current
- Efficiency up to 96%
- Wide operating temperature range from -40°C to +85°C without derating
- IEC/EN62368-1 certified



RBBA3000

50 Amp Half Brick Buck/Boost converter



IEC/EN62368-1 certified
EN55032 compliant
CB Report

Description

The RBBA3000 is a high efficiency non-isolated buck/boost converter with up to 50A output current in a half-brick case. The input voltage range is from 9-60VDC and the output voltage (0-60V) and current (0-50A) are independently set via fixed trim resistors or an external voltage. The I_{share} pin has two functions: it can be used to monitor the load current in stand-alone applications or it can be used to connect three modules in parallel to double the maximum output current to 100A. Typical applications are 48V to 24V or 12V to 24V battery power conversion, electric vehicles, battery voltage stabilizers or high power laboratory DC power supplies. With appropriate cooling, the full power operating temperature extends from -40°C to +85°C and the RBBA3000-50 comes with RECOM's standard 2 year warranty.

Selection Guide

Part Number	Input Voltage Range [VDC]	Input Current max. [A]	Nom. Output Voltage [VDC]	Output Current max. [A]	Efficiency typ. ⁽¹⁾ [%]
RBBA3000-50	9 - 60	50	0 - 60	50	96

Notes:

Note1: Efficiency is tested at nominal input and 24Vout at +25°C ambient

Model Numbering

RBBA3000-50

_____ max. Output Current

Specifications (measured @ Ta= 25°C, 2.5m/s, nom. Vin, 24Vout and after warm-up unless otherwise stated)

BASIC CHARACTERISTICS					
Parameter	Condition		Min.	Typ.	Max.
Internal Input Filter			Pi-Type		
Input Voltage Range ⁽²⁾	nom. Vin = 48VDC		9VDC		60VDC
Absolute Maximum Input Voltage	100ms				80VDC
Undervoltage Lockout Threshold	DC-DC ON		7VDC	8VDC	9VDC
	DC-DC OFF		5VDC	6VDC	7VDC
Undervoltage Lockout Hysteresis				2VDC	
Input Current ⁽³⁾	low line to high line				50A
Quiescent Current	no load Vin = 24VDC	Vout = 12VDC Vout = 24VDC Vout = 48VDC		100mA 90mA 180mA	
Internal Power Dissipation	refer to „Power Dissipation vs. Output Current“				
Output Current Range ⁽²⁾			0A		50A
Output Voltage Trimming ⁽⁴⁾			0VDC		60VDC

Notes:

Note2: For detail information please refer to “Safe Operating Area”

Note3: For detail information please refer to “PROTECTIONS”

Note4: For detail information please refer to “Output Voltage Trimming”

continued on next page

Specifications (measured @ Ta= 25°C, 2.5m/s, nom. Vin, 24Vout and after warm-up unless otherwise stated)

Parameter	Condition	Min.	Typ.	Max.
Minimum Load		0%		
Start-up time	ON/OFF CTRL Power Up		30ms 30ms	
Rise Time			300mV/ms	
ON/OFF CTRL ⁽⁵⁾	DC-DC ON DC-DC OFF			0VDC < V _{CTRL} < 0.8VDC 3.5VDC < V _{CTRL} < V _{IN}
Input Current of CTRL Pin	nom. Vin= 48VDC		1mA	
Standby Current	nom. Vin= 48VDC DC-DC OFF		2mA	
Current Monitor or Current Share "Ishare"	reference voltage at no load reference voltage at full load (50A)		0.2VDC 2.7VDC	
Ishare Reading Error	I _{OUT} = 50-100% of I _{OUT} max I _{OUT} = 5-50% of I _{OUT} max	-5% -3A		+5% 3A
Internal Operating Frequency		100kHz	280kHz	400kHz
Output Ripple and Noise ⁽⁶⁾	20MHz BW		100mVp-p	
Absolute Maximum Capacitive Load	<1 second start up			15000µF

Notes:

Note5: The ON/OFF CTRL is normally OFF

Note6: Measurements are made with a 100µF E-Cap across output (low ESR)

Efficiency vs. Load

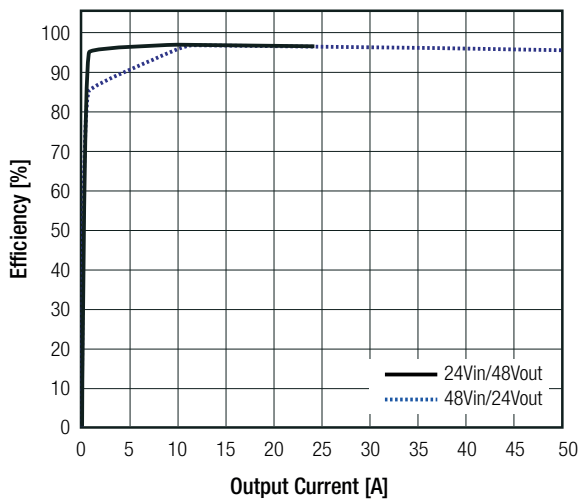

Power Dissipation vs. Output Current

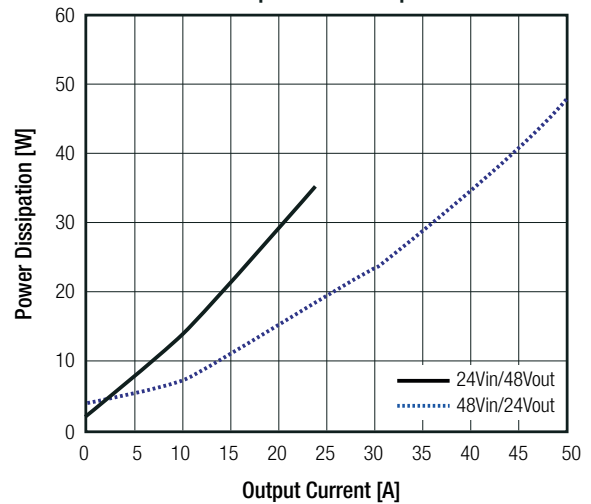

Safe Operating Area

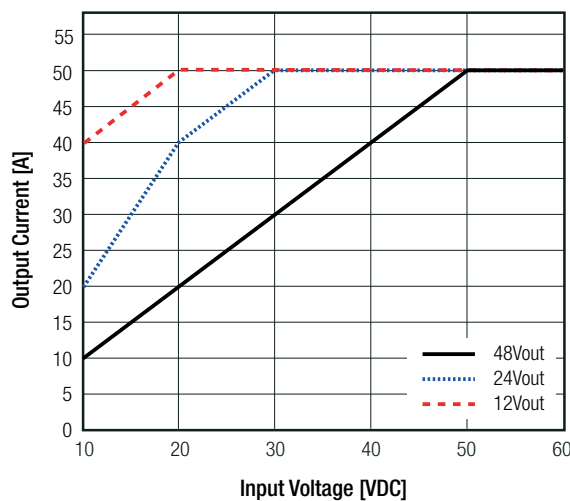

continued on next page

Specifications (measured @ Ta= 25°C, 2.5m/s, nom. Vin, 24Vout and after warm-up unless otherwise stated)

Output Voltage Trimming

The RBBA3000 series offers the feature of trimming the output voltage over a range between 0V and 60V by using precision trim resistors between the Trim and -Sense pin (1% recommended). Undriven Trim pin will set Vout to 0VDC.

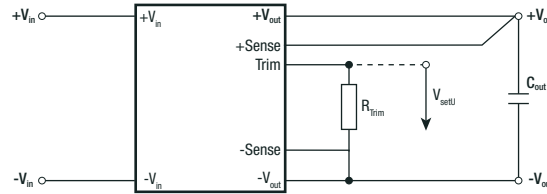

- Vout_{max} = maximum output voltage [VDC]
- Vout_{set} = trimmed output voltage [VDC]
- k = trim up factor []
- V_{setU} = set voltage [VDC]
- V_{ref1}, V_{ref2} = reference voltage [VDC]
- R_{trim} = trim resistor [Ω]
- R₁, R₂ = internal resistors [Ω]

Vout _{max}	R ₁	R ₂	k	V _{ref1}	V _{ref2}
60VDC	11k915Ω	10k870Ω	0.05765	2.366	2.316

Calculation:

$$R_{Trim} = \left[\frac{R_1 \times V_{out_{max}}}{V_{out_{set}} + k \times V_{out_{max}}} \right] - R_2$$

Additionally the Trim pin can be driven from an external voltage source:

$$V_{setU} = V_{ref1} - V_{ref2} \times \left[\frac{V_{out_{set}}}{V_{out_{max}}} \right]$$

Practical Example RBBA3000-50 (set Vout to 24VDC):

$$R_{Trim} = \frac{11k915 \times 60}{24 + 0.05765 \times 60} - 10k870 = \underline{\underline{15k165\Omega}}$$

$$V_{setU} = 2.366 - 2.316 \times \left[\frac{24}{60} \right] = \underline{\underline{1.44V}}$$

R_{Trim} according to E96 ≈ 15kΩ

REMOTE SENSE

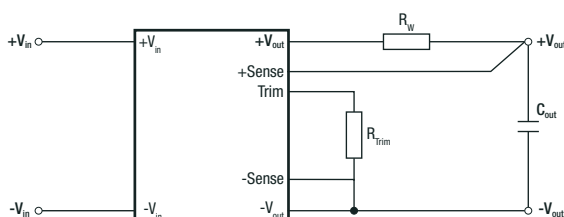

The output voltage can be adjusted via the Trim and -Sense functions. The maximum output voltage from Trim and -Sense function combined is 60VDC. The maximum allowed voltage between +Sense and +Vout pins is 6VDC. Derating may be required when using trim and/or sense functions. A minimum capacitance value of 100µF is required across the output.

- R_w ... wire losses
- R_{trim} ... trim resistor

Specifications (measured @ Ta= 25°C, 2.5m/s, nom. Vin, 24Vout and after warm-up unless otherwise stated)

REGULATIONS		
Parameter	Condition	Value
Output Accuracy	exclusive R _{Trim} tolerances	±0.5% typ.
Line Regulation	low line to high line, full load	±1.0% typ.
Load Regulation	0% to 100% load	-4.0% x Vout x (Iout/Iout _{max})
Transient Response	25% load step recovery time	600mV max. 200µs typ.
Remote Sense	between +Vout and +Sense between -Vout and -Sense	6VDC max. 0.25VDC max.

PROTECTIONS		
Parameter	Condition	Value
Input Over Voltage Protection	150ms delay	65VDC
Input Current Limit	low line to high line	55A typ.
Output Short Circuit Protection	fixed using I _{set} ⁽⁷⁾	hiccup mode, 55A typ. hiccup mode, 0-50A
Output Over Voltage Protection (OVP)	V _{OUTset} < 3.5VDC 3.5VDC < V _{OUTset} < 47.5VDC V _{OUTset} > 47.5VDC	latch off, 5VDC latch off, 1.43 x V _{OUTset} latch off, 68VDC typ.
Over Temperature Protection (OTP)	measured at tc point	110°C, restart after cool down

Notes:

Note7: The RBBA3000 series offers the feature of trimming the output current over a range between 0A and 50A by using an external resistor between the I_{set} and the -Vin pin (1% recommended).

Output Current Setting

- I_{out_{max}} = maximum output current [A]
- I_{out_{set}} = trimmed output current [A]
- k₁, k₂, k₃ = trim up factor []
- V_{set1} = set voltage [VDC]
- R_{Iset} = trim resistor [kΩ]

I _{out_{max}}	k ₁	k ₂	k ₃
50A	25	3.3	2.5

Calculation:

$$R_{Iset} = \frac{k_1 \times I_{out_{set}}}{k_2 \times I_{out_{max}} - k_3 \times I_{out_{set}}}$$

Additionally the I_{set} pin can be driven from an external voltage source V_{set1}:

$$V_{set1} = k_3 \times \left[\frac{I_{out_{set}}}{I_{out_{max}}} \right]$$

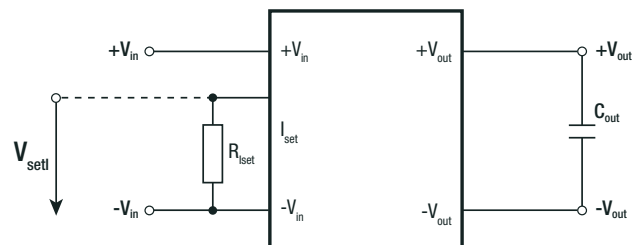

Practical Example RBBA3000-50:

$$R_{Iset} = \frac{25 \times 40}{3.3 \times 50 - 2.5 \times 40} = \underline{\underline{15k38\Omega}}$$

R_{Iset} according to E96 ≈ 15k4Ω

$$V_{set1} = 2.5 \times \left[\frac{40}{50} \right] = \underline{\underline{2V}}$$

Specifications (measured @ Ta= 25°C, 2.5m/s, nom. Vin, 24Vout and after warm-up unless otherwise stated)

ENVIRONMENTAL

Parameter	Condition	Value
Operating Temperature Range ⁽⁸⁾		refer to "Derating Graph"
Maximum Baseplate Temperature		+110°C
Temperature Coefficient ⁽⁸⁾	@ 2.5m/s convection and baseplate mounting	0.05%/K
Thermal Impedance	@ 2.5m/s convection and baseplate mounting	1.2K/W
Operating Altitude ⁽⁸⁾	@ 2.5m/s convection (refer to "Operating Altitude vs. Load")	5000m
Operating Humidity	non-condensing	5% - 95% RH max.
MTBF	according Telcordia SR332 Method I Reliability Prediction at 48Vin, 25°C and 80% load	1300 x 10 ³ hours

Notes:

Note8: tested with a test PCB 185x185mm 105µm copper, double layer

Derating Graph ⁽⁸⁾
(@ chamber)

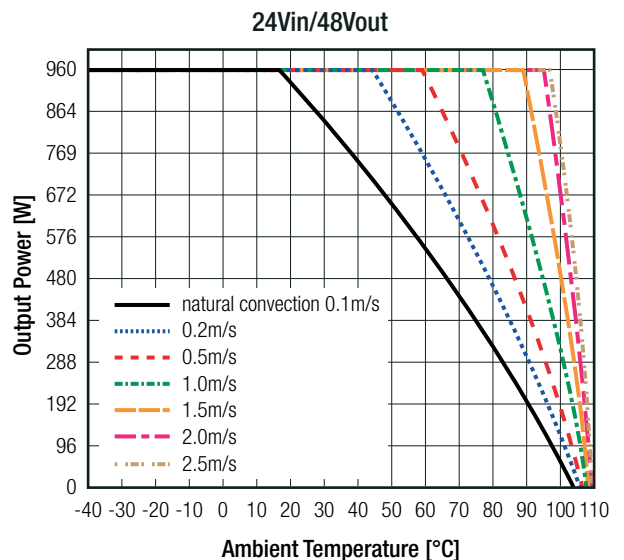
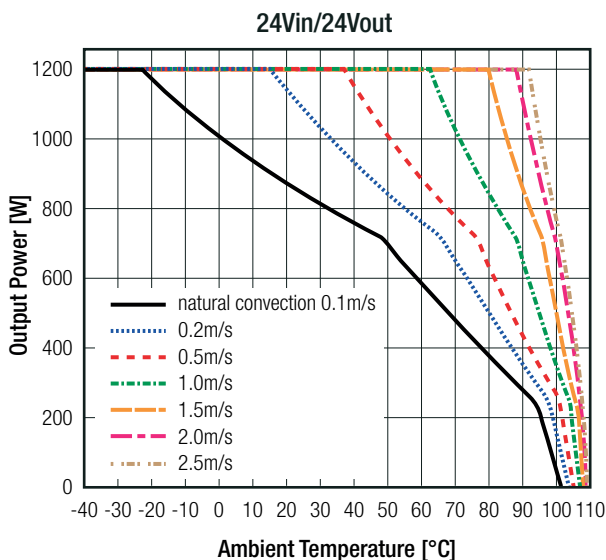
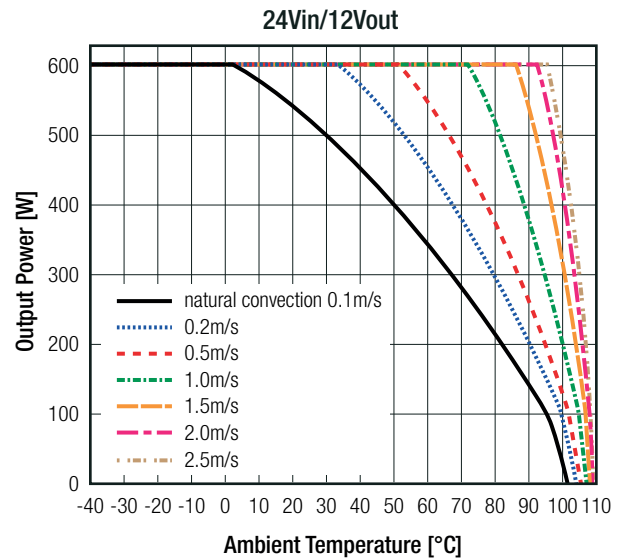
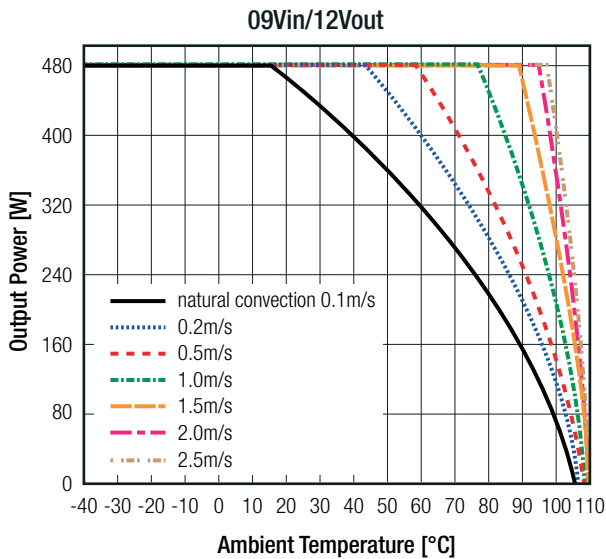

continued on next page

Specifications (measured @ Ta= 25°C, 2.5m/s, nom. Vin, 24Vout and after warm-up unless otherwise stated)

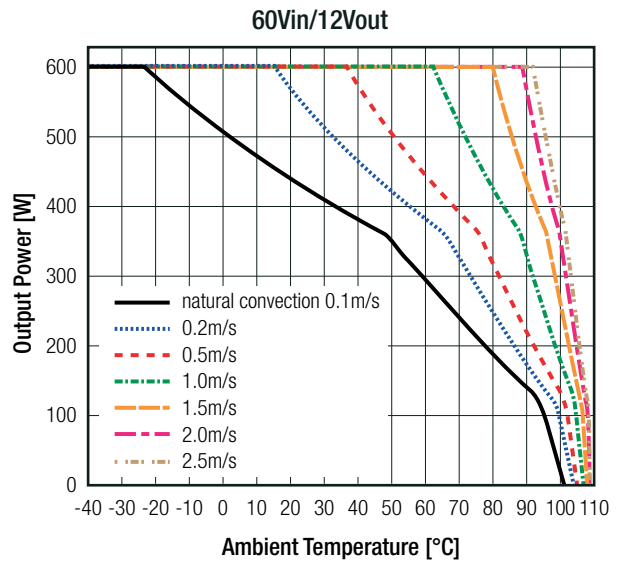
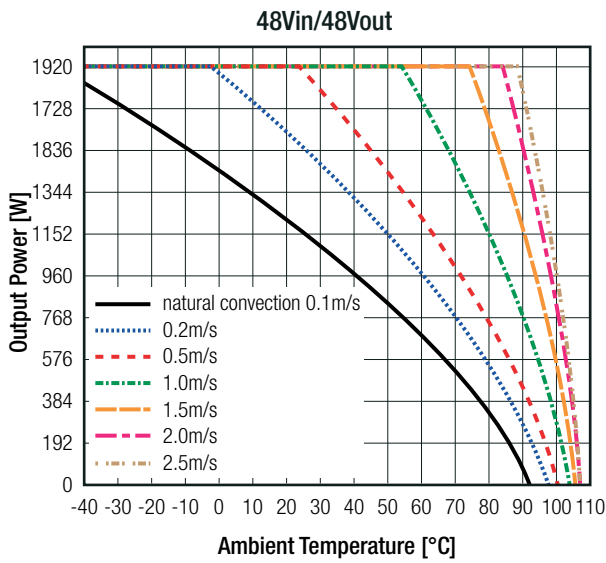
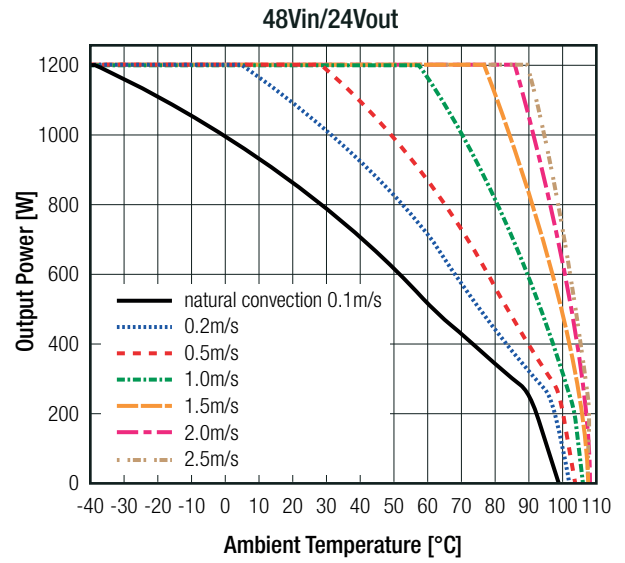
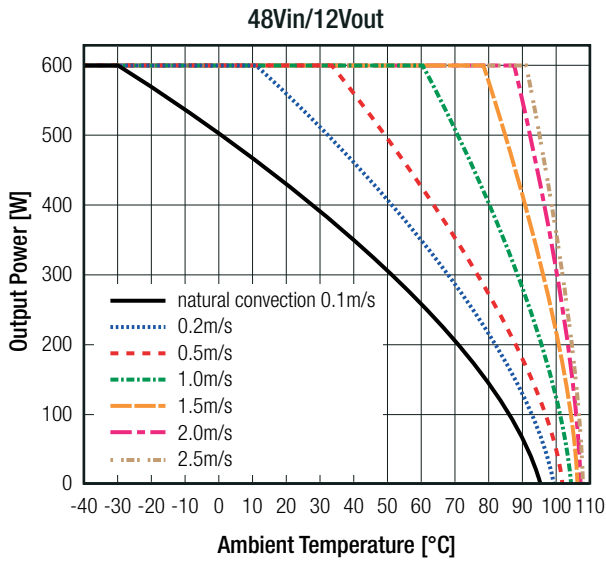

Operating Altitude vs. Load
(@ chamber and 2.5m/s convection)

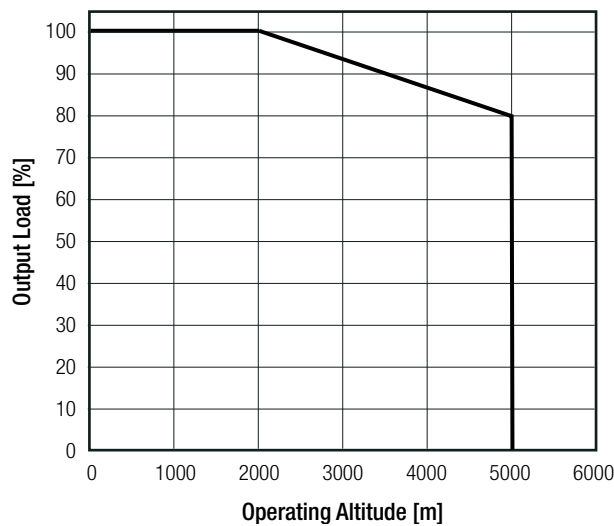

Specifications (measured @ Ta= 25°C, 2.5m/s, nom. Vin, 24Vout and after warm-up unless otherwise stated)

Thermal Calculation:

$$P_{diss} = P_{in} - P_{out} = \frac{P_{out}}{\eta} - P_{out}$$

$$T_{over} = R_{th} \times P_{diss}$$

$$T_{amb} = T_{base\ max.} - T_{over}$$

$T_{base\ max.}$	= max. baseplate temperature	[°C]
T_{over}	= temperature losses	[°C]
T_{amb}	= ambient temperature	[°C]
P_{out}	= output power	[W]
η	= efficiency (see graph)	[%]
P_{diss}	= internal losses	[W]
R_{th}	= thermal impedance	[K/W]

Practical Example:

Take the **RBBA3000-50** with 48V Input Voltage, 24V Output Voltage, 50A Output Current:
What is the maximum ambient operating temperature?

$T_{base\ max.}$	= 110°C
P_{out}	= 1200W
η	= 96%
R_{th}	= 1.2K/W ⁽⁸⁾

$$P_{diss} = \frac{1200W}{0.96} - 1200W = 50W$$

$$T_{over} = 1.2K/W \times 50W = 60K$$

$$T_{amb} = 110°C - 60K = +50°C$$

SAFETY AND CERTIFICATIONS

Certificate Type (Safety)	Report / File Number	Standard
Audio/video, information and communication technology equipment. Safety requirements (CB Scheme)	E224736-A6003-CB-1	IEC62368-1:2014 2nd Edition
Audio/video, information and communication technology equipment. Safety requirements		EN62368-1:2014 + A11:2017
RoHS2+		RoHS 2011/65/EU + AM2015/863

EMC Compliance	Condition	Standard / Criterion
Electromagnetic compatibility of multimedia equipment - Emission requirements	with external filter (see suggestion below)	EN55032, Class A and B
Information technology equipment - Immunity characteristics - Limits and methods of measurement		EN55024

EMC Filtering Suggestions according to EN55032

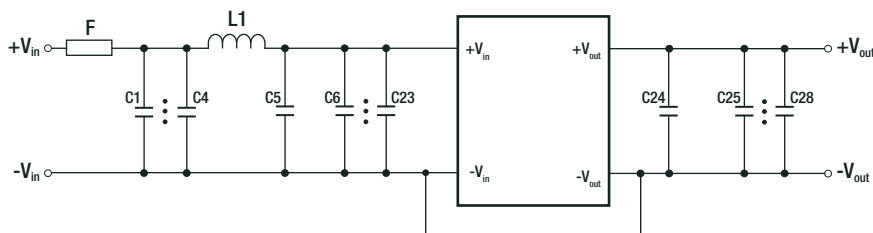

Component List Class A and B

C1-C4	L1	C5	C6-C23	C24	C25-C28
2.2µF/100V MLCC 4pcs	3.3µH/100A 1pc	470µF/100V E-Cap 1pc	2.2µF/100V MLCC 18pcs	470µF/100V E-Cap 1pc	2.2µF/100V MLCC 4pcs

DIMENSION AND PHYSICAL CHARACTERISTICS

Parameter	Type	Value
Material	baseplate case potting	aluminum plastic (UL94 V-2) low smoke silicone (UL94 V-0)
Dimension (LxWxH)		60.60 x 63.2 x 13.0mm
Weight		155g typ.

continued on next page

Specifications (measured @ Ta= 25°C, 2.5m/s, nom. Vin, 24Vout and after warm-up unless otherwise stated)

Dimension Drawing (mm)

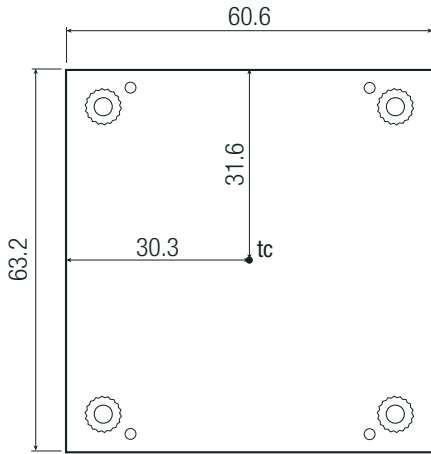
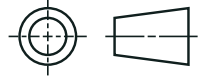

Pin Information

Pin #	Function	Pin #	Function
1	+Vin	7	-Vout
2	CTRL	8	-Sense connect to -Vout
3	SyncIn connect to -Vin	9	Trim
4	Iset	10	+Sense
5	Ishare	11	+Vout

xx.x ± 0.5mm
 xx.xx ± 0.25mm
 FC= fixing center
 max. tightening torque of mounting holes=0.60Nm

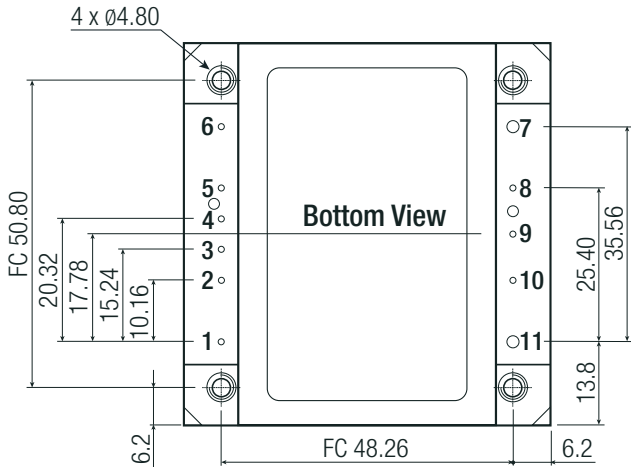
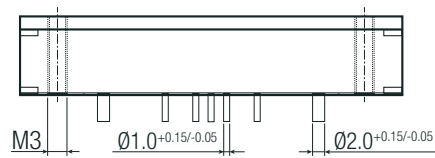
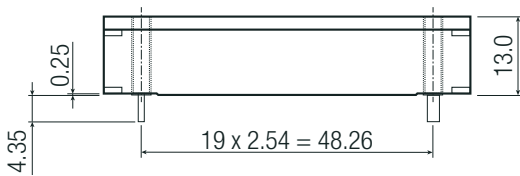

Recommended Footprint Details

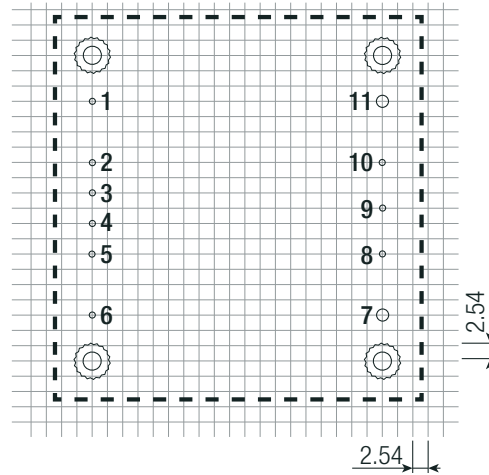

INSTALLATION AND APPLICATION

48Vin to 24Vout converter

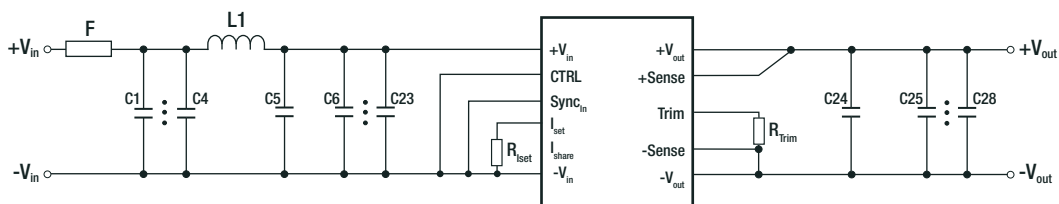

Input	C1-C4	L1	C5	C6-C24	R _{iset}	R _{trim}	C24	C25-C28	Output
48Vin	2.2µF/100V MLCC 4pcs	3.3µH/100V 1pc	470µF/100V E-Cap 1pc	2.2µF/100V MLCC 18pcs	15kΩ	15kΩ	470µF/100V E-Cap 1pc	2.2µF/100V MLCC 4pcs	24Vout 40A

Specifications (measured @ Ta= 25°C, 2.5m/s, nom. Vin, 24Vout and after warm-up unless otherwise stated)

PACKAGING INFORMATION		
Parameter	Type	Value
Packaging Dimension (LxWxH)	tray	380.0 x 230.0 x 20.0mm
Packaging Quantity		12pcs
Storage Temperature Range		-55°C to +125°C
Storage Humidity	non-condensing	95% RH max.

The product information and specifications may be subject to changes even without prior written notice. The product has been designed for various applications; its suitability lies in the responsibility of each customer. The products are not authorized for use in safety-critical applications without RECOM's explicit written consent. A safety-critical application is an application where a failure may reasonably be expected to endanger or cause loss of life, inflict bodily harm or damage property. The applicant shall indemnify and hold harmless RECOM, its affiliated companies and its representatives against any damage claims in connection with the unauthorized use of RECOM products in such safety-critical applications.