

Middle Power LED PLCC Series

P-Series 0.5W White SPMWHT346EA3

Features

- Package : Au Plated 4 pad design package with silicone resin
- Dimension : 3.2 mm x 2.8 mm
- Technology : Epi-up
- Color Coordinate Group : Appropriate to ECE
- Chip Configuration : 1 chip
- ESD Voltage : Up to 2 kV acc. to ANSI/ESDA/JEDEC JS-001 (HBM, Class 3B)
- Viewing Angle: 120°
- Qualifications: The product qualification test based on the guidelines of AEC-Q101-REV-C.

Table of Contents

1.	Characteristics	-----	3
2.	Product Code Information	-----	4
3.	Typical Characteristics Graphs	-----	7
4.	Soldering Temperature Location	-----	12
5.	Mechanical Dimension	-----	13
6.	Soldering Conditions	-----	14
7.	Tape & Reel	-----	15
8.	Label Structure	-----	16
9.	Packing Structure	-----	17
10.	Precautions in Handling & Use	-----	18
11.	Company Information	-----	19

1. Characteristics

a) Typical Characteristics

[T_S= 25°C] ^[1]

Item	Symbol	Value	Unit.
Luminous Flux (I _F = 140 mA)	I _V	Typ. 13.0	cd
Forward Voltage (I _F = 140 mA)	V _F	Typ. 3.5	V
Viewing Angle	φ	Typ. 120	°
Reverse Current	I _R	10	μA
Real Thermal Resistance (Junction to Solder point)	R _{th_J-S (Real)}	Typ. 57	K/W
		Max. 69	
Electrical Thermal Resistance (Junction to Solder point)	R _{th_J-S (Elec.)}	Typ. 45	K/W
		Max. 55	
Radian Surface	A	4.52	mm ²

Notes:

[1] Measurement condition means that temperature dependence is excluded by applying pulse current for typically 25ms.

b) Absolute Maximum Rating

Item	Symbol	Rating	Unit
Ambient / Operating Temperature	T _a	-40 ~ +125	°C
Storage Temperature	T _{stg}	-40 ~ +125	°C
LED Junction Temperature	T _j	150	°C
Maximum Forward current ^[2] (T _S : 25°C) ^[3]	I _F	250	mA
Minimum Forward current ^[2] (T _S : 25°C) ^[3]	I _F	30	mA
Maximum Reverse current		Do not apply for reverse current	
ESD Sensitivity ^[4]	-	±2 HBM	kV

Notes:

[2] Driving the product at forward current(I_F) below Min. I_F or above Max. I_F may result in unpredictable behavior of product.

[3] The measurement condition means that temperature dependence is excluded by applying pulse current for typically 25ms.

[4] It is recommended to use the LED with additional protection device (for example Zener diode) to protect it against ESD.

2. Product Code Information

1	2	3	4	5	6	7	8	9	10	11	12	13	14	15	16	17	18
S	P	M	W	H	T	3	4	6	E	A	3	A	B	C	D	E	F

Digit	PKG Information
1 2	company name and Samsung LED PKG (SP for Samsung PKG)
3	power variant (H for automotive high power)
4 5	color variant (WH for automotive white color)
6	LED PKG version (T for initial version)
7 8 9	product configuration and type (346 for automotive 3228 PKG Au plate type)
10	operation condition (E for 140mA)
11	specific property (A for Automotive)
12	CRI Variant (3 for CRI Min. 70)
13 14	forward voltage property
15 16	CIE coordination property
17 18	luminous flux property

a) Luminous Intensity Bins ^[5] ($I_F= 140 \text{ mA}$, $T_S= 25 \text{ }^\circ\text{C}$)

Symbol	Bin Code	Intensity Range (cd)		Flux Range (lm)	
		Min	Max	Min	Max
$I_V \Phi_V$	B2	10.0	12.0	27.0	32.4
	B3	12.0	14.0	32.4	37.8
	B4	14.0	16.0	37.8	43.2
	B5	16.0	18.0	43.2	48.6

b) Voltage Bins ^[5] ($I_F= 140 \text{ mA}$, $T_S= 25 \text{ }^\circ\text{C}$)

Symbol	Bin Code	Voltage Range (V)	
		Min	Max
V_F	C1	2.9	3.2
	C2	3.2	3.5
	C3	3.5	3.8
	C4	3.8	4.1

Notes:

[5] Luminous intensity measuring equipment: CAS140CT Φ_V and V_F tolerances are $\pm 7\%$ and $\pm 0.1\text{V}$, respectively.

Given tolerances are valid for typical conditions.

c) Color Bins ^[6] ($I_F = 140 \text{ mA}$)

Symbol	Bin Code	C_x				C_y			
C_x, C_y	M1	0.3205	0.3197	0.3288	0.3288	0.2956	0.3131	0.3282	0.3081
	M2	0.3288	0.3288	0.3386	0.3386	0.3081	0.3282	0.3426	0.3235
	M3	0.3386	0.3386	0.3484	0.3484	0.3235	0.3426	0.3571	0.3388
	M4	0.3484	0.3484	0.3582	0.3582	0.3388	0.3571	0.3715	0.3542

Note

[6] Chromaticity coordinates: C_x, C_y according to CIE 1931. C_x and C_y tolerances are ± 0.005 , respectively.

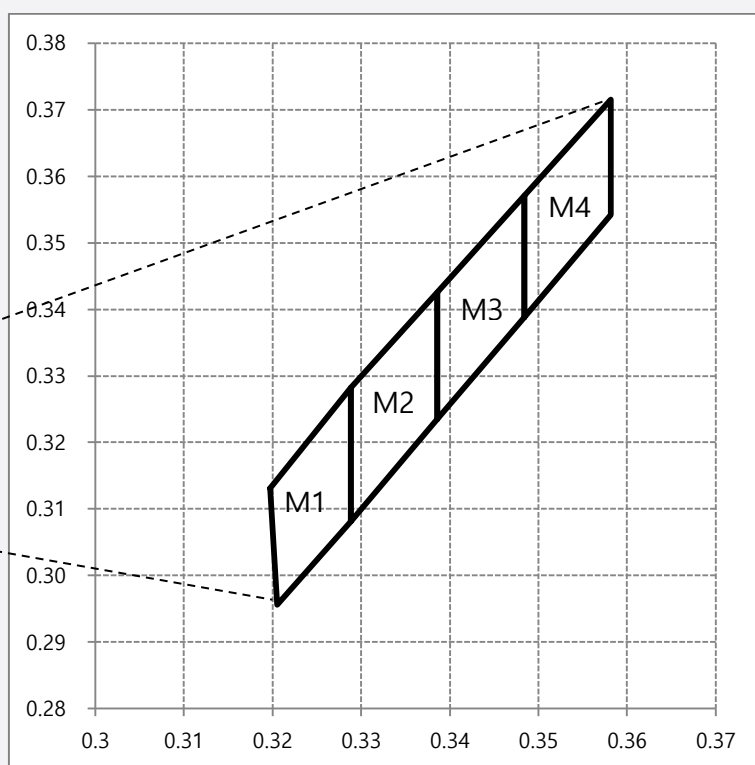
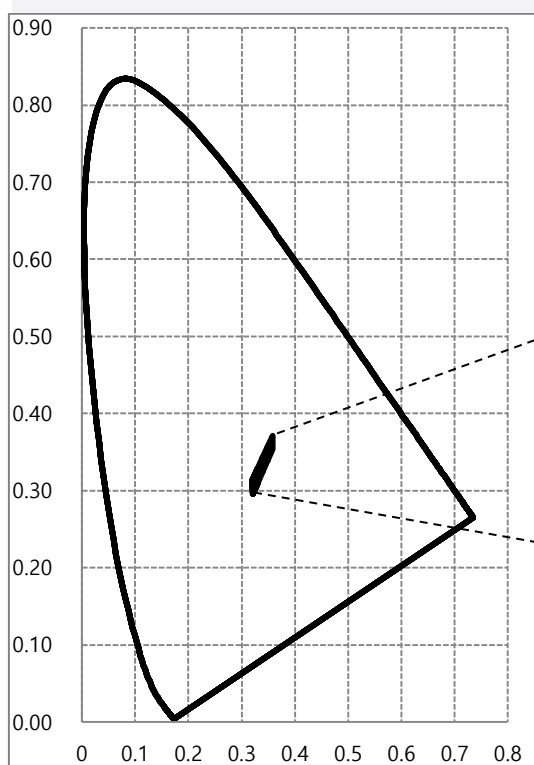

3. Typical Characteristics Graphs

a) Spectrum Distribution ($I_F = 140 \text{ mA}$, $T_s = 25 \text{ }^\circ\text{C}$)^[7]

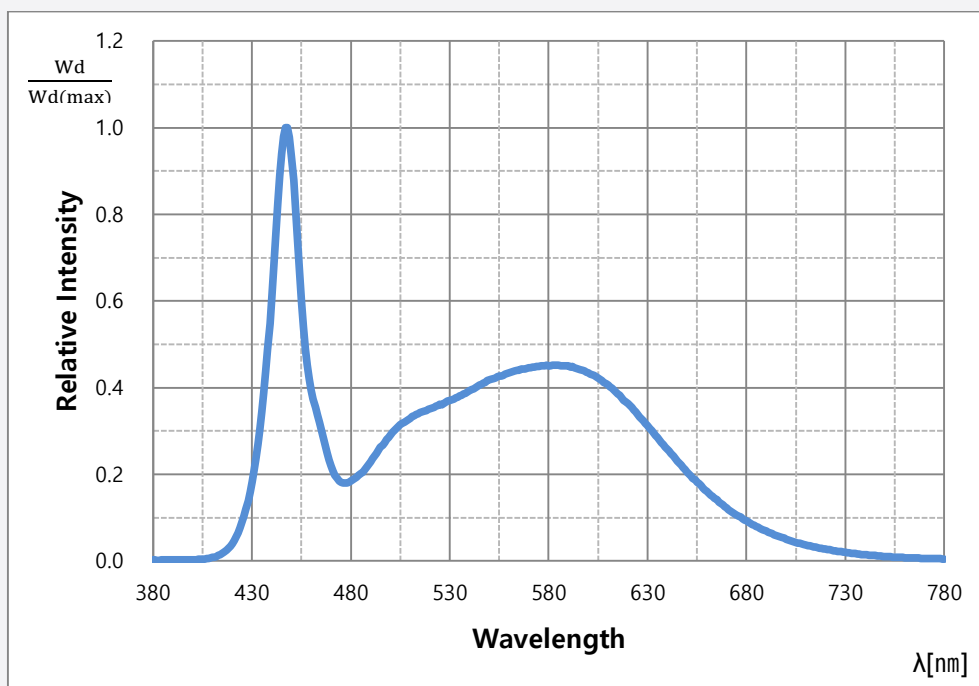

b) Typical Chromaticity Coordinate Shift vs Radiation Angle ($I_F = 140 \text{ mA}$, $T_s = 25 \text{ }^\circ\text{C}$)^[7]

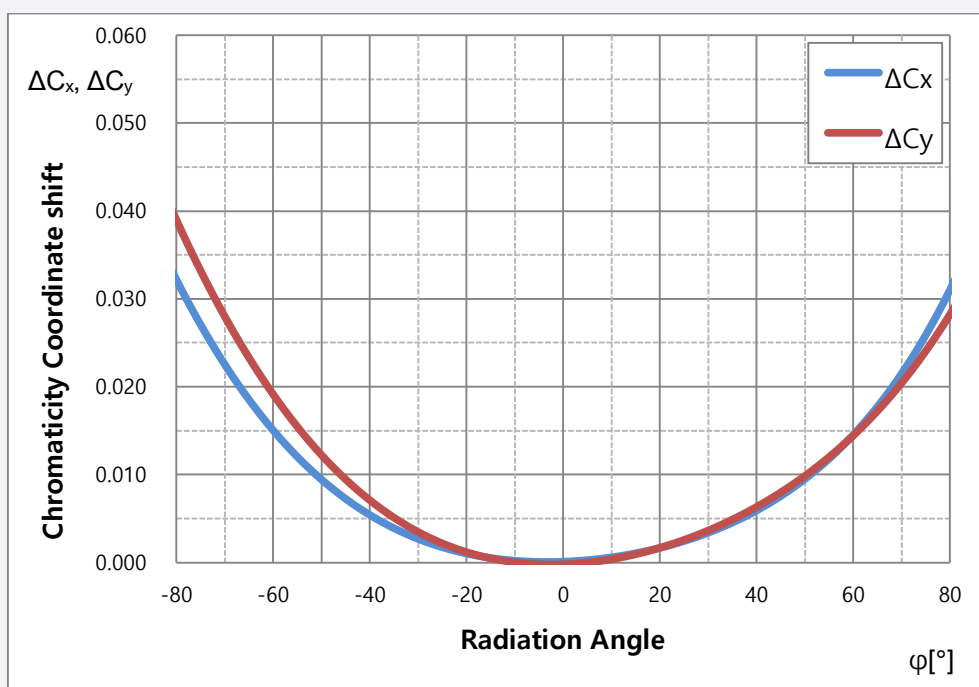

Notes:

[7] The measurement condition means that temperature dependence is excluded by applying pulse current for typically 25ms.

c) Forward Current Characteristics ($T_s = 25\text{ }^\circ\text{C}$) [8]

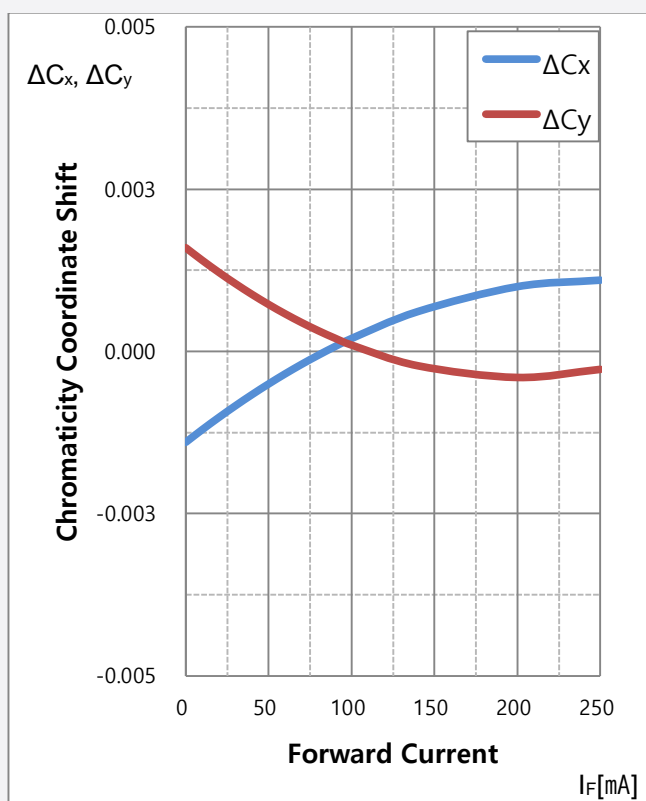
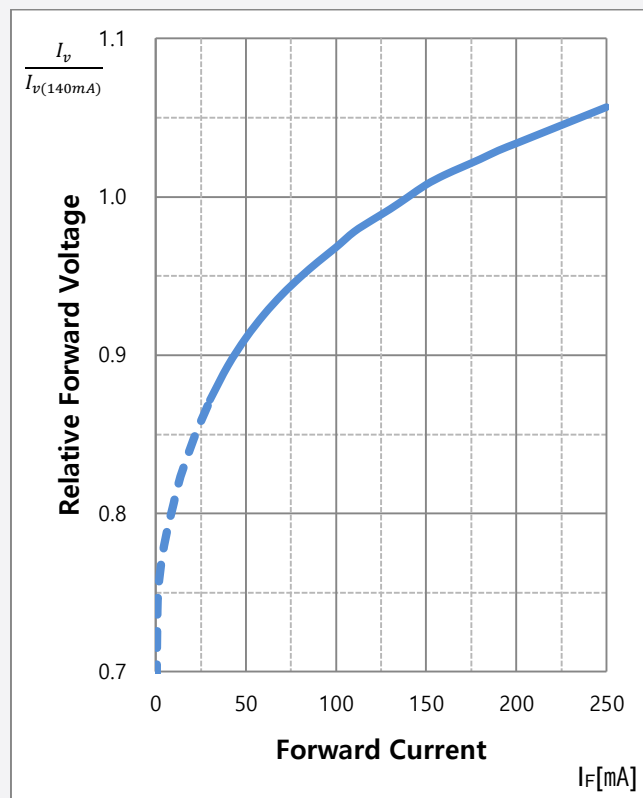
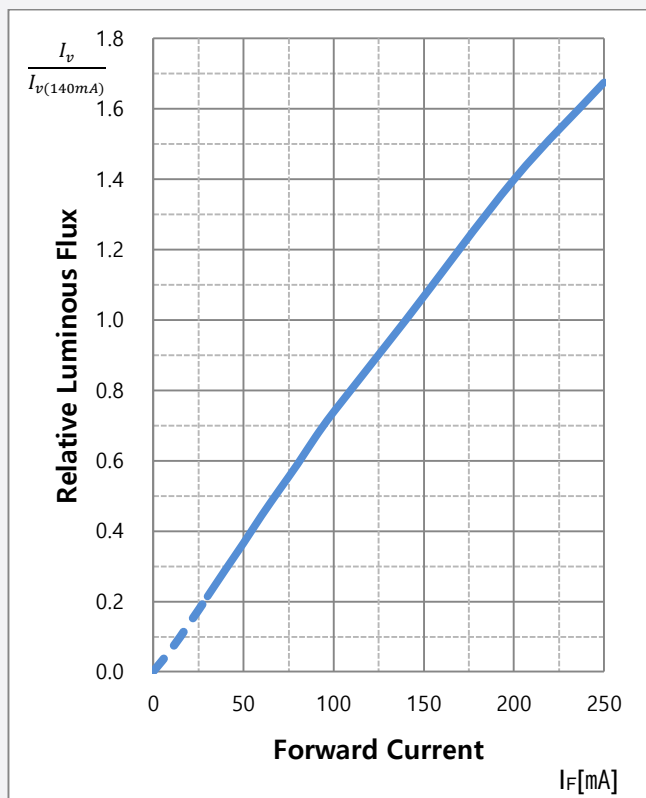

Notes:

[8] The measurement condition means that temperature dependence is excluded by applying pulse current for typically 25ms

d) Temperature Characteristics ($I_f = 140 \text{ mA}$)

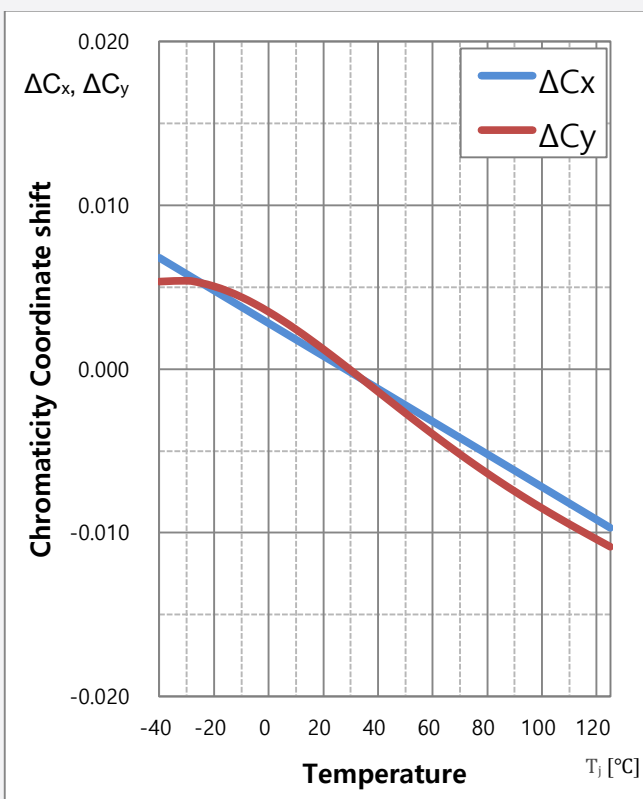
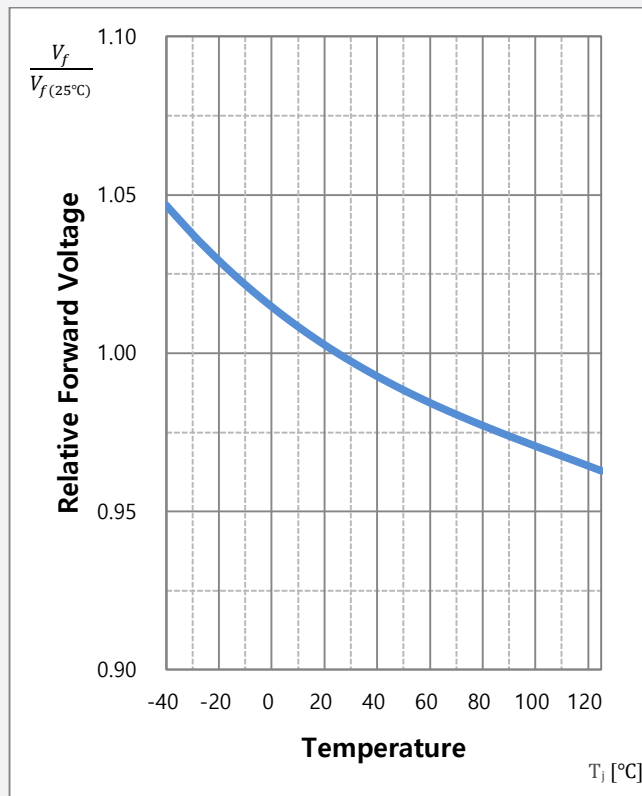
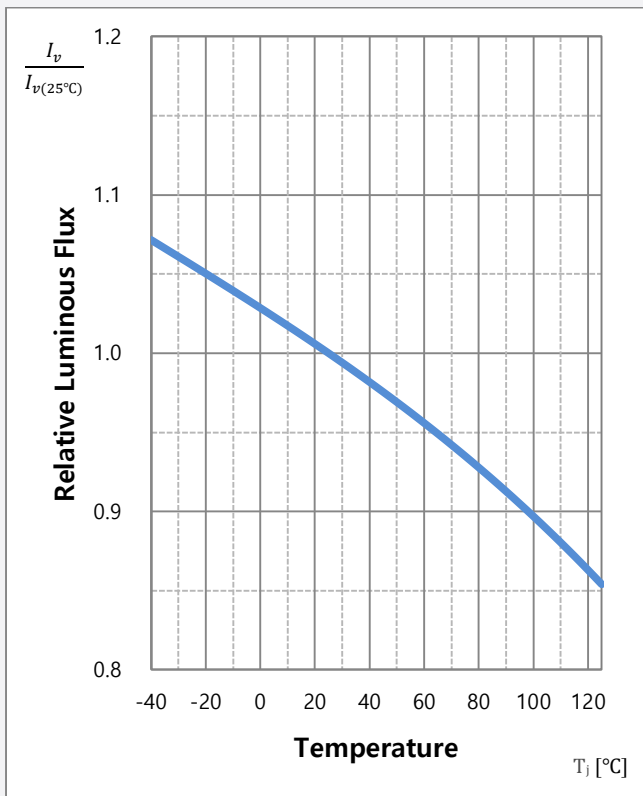

e) Derating Curve ^[9]

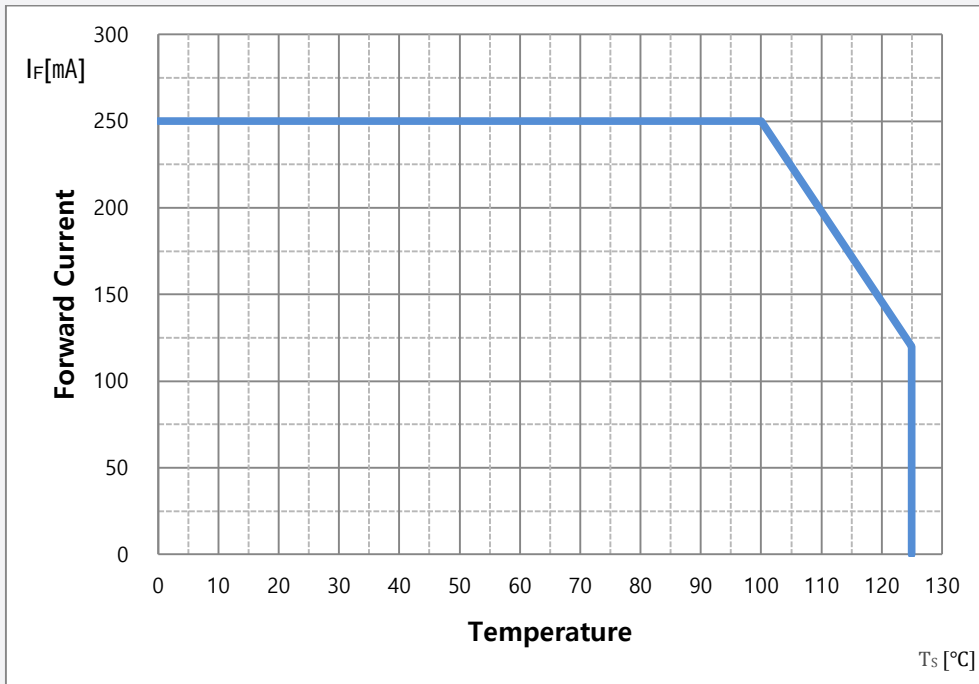

Notes:

[9] The measurement condition means that temperature dependence is excluded by applying pulse current for typically 25ms

f) Permissible Pulse Handling Capability ($I_F = f(t_p)$; D: Duty cycle)

$T_s = 0 \sim 100^\circ\text{C}$

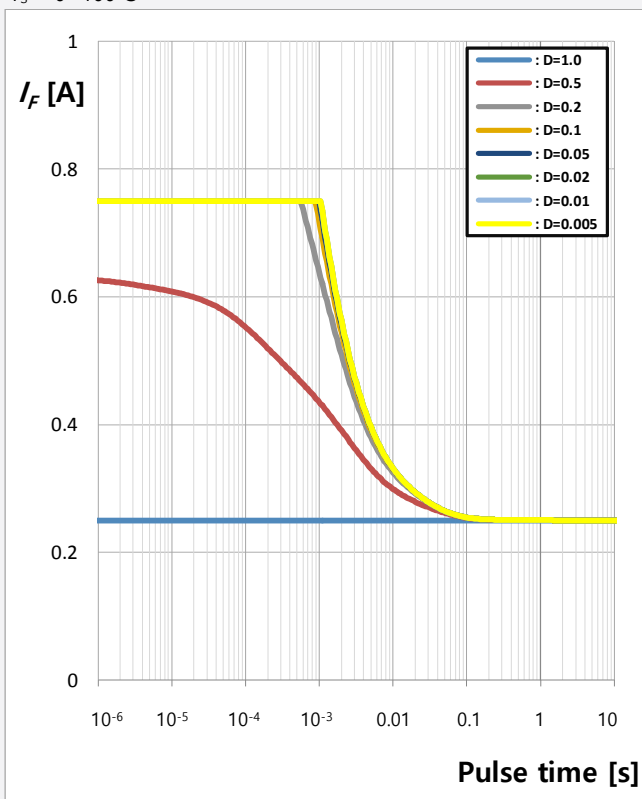

$T_s = 125^\circ\text{C}$

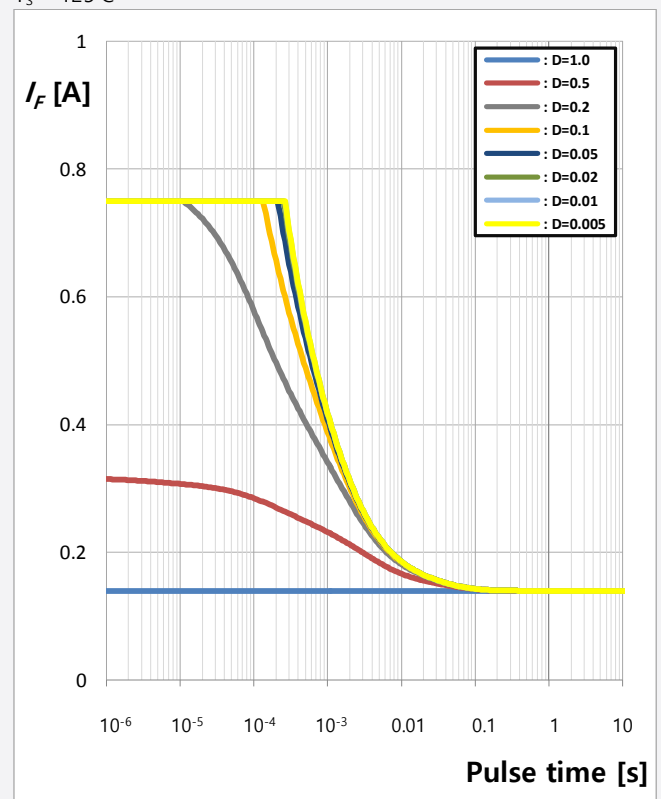

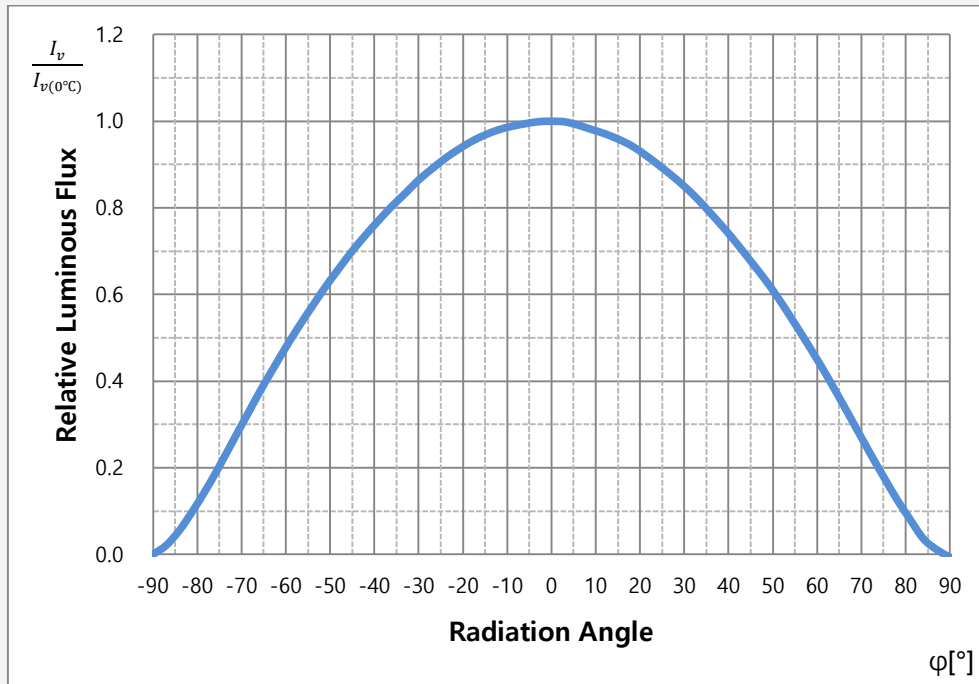
g) Beam Angle Characteristics ($I_F = 140 \text{ mA}$, $T_s = 25 \text{ }^\circ\text{C}$)

4. Soldering Temperature Location

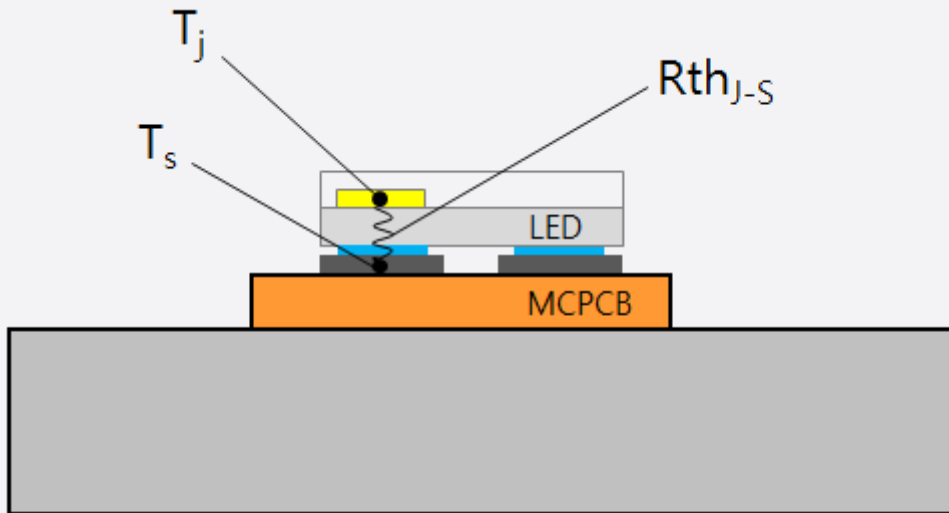

T_j : Temperature of Junction

T_s : Temperature of Solder Pad

$R_{th_{J-S}}$: Thermal Resistance from Junction to Solder Pad

5. Mechanical Dimension

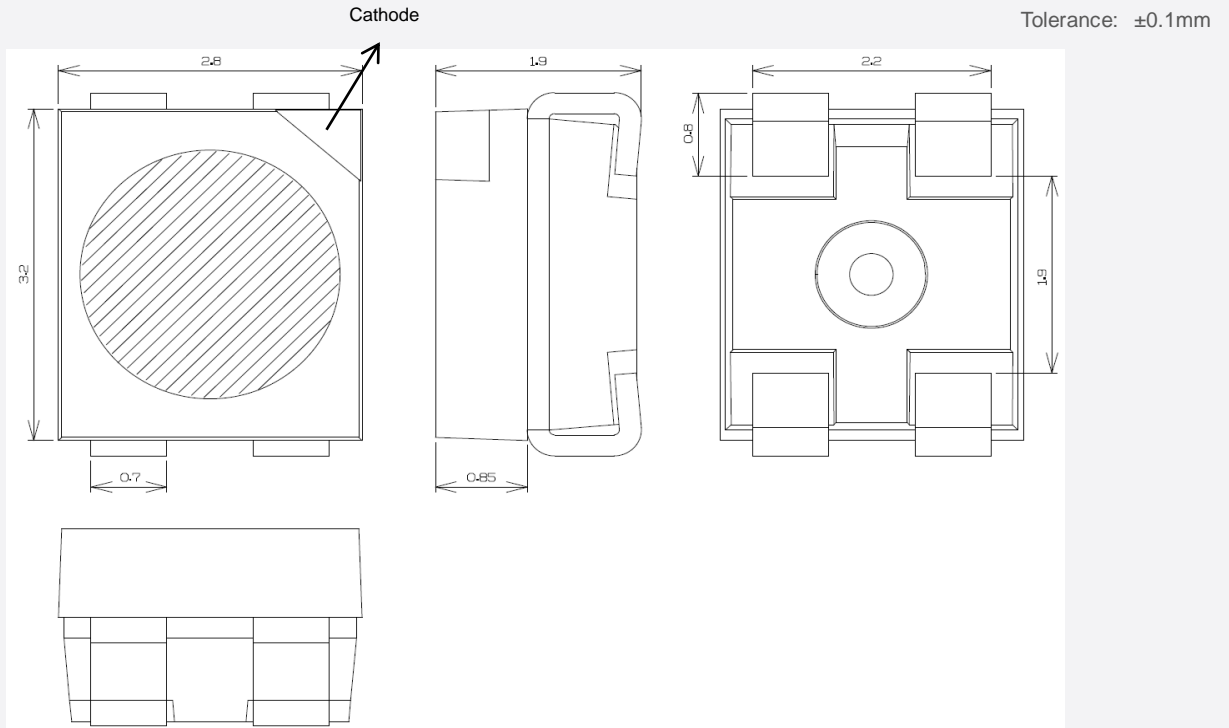

Notes:

Unit: mm, Tolerance: ±0.1mm Approximate Weight : 36mg

a) Pick and Place

Do not place pressure on the resin lens (hatch area).
The maximum compressing force is 15N in the polymer.

b) Electric Schematic Diagram

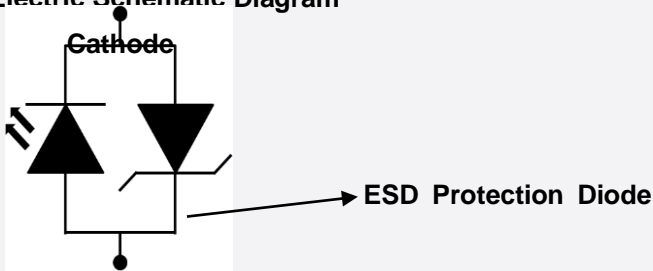

[Circuit]

c) Material Information

Description	Material
Lead Frame	PLCC
LED Die	Epi-up
Wire	Au
Resin Mold	Silicone

6. Soldering Conditions

a) Pad Configuration & Solder Pad Layout

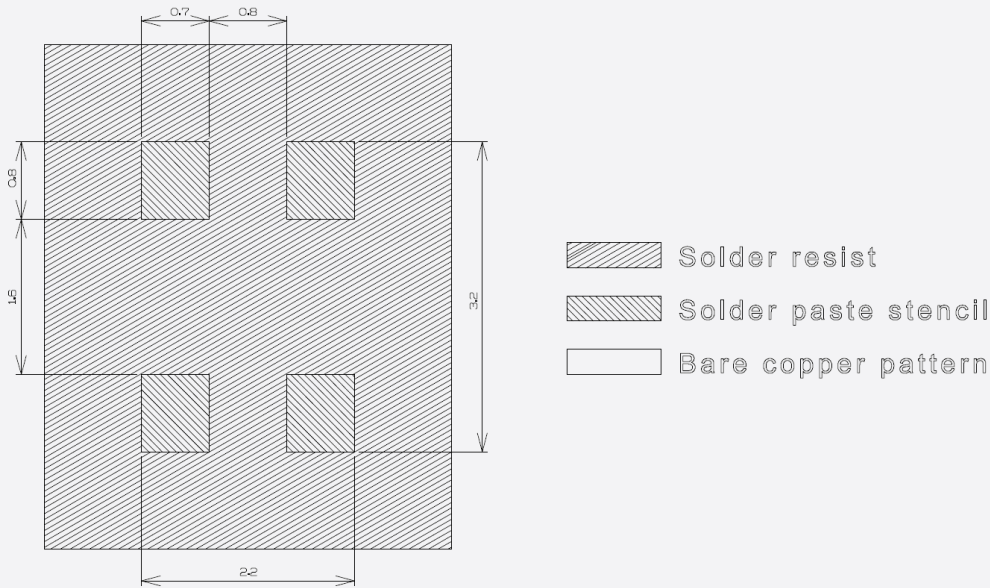

Recommended Solder Pad

Notes:

Unit: mm, Tolerance: ±0.1mm

b) Reflow Conditions (Pb free)

Reflow frequency: 2 times max.

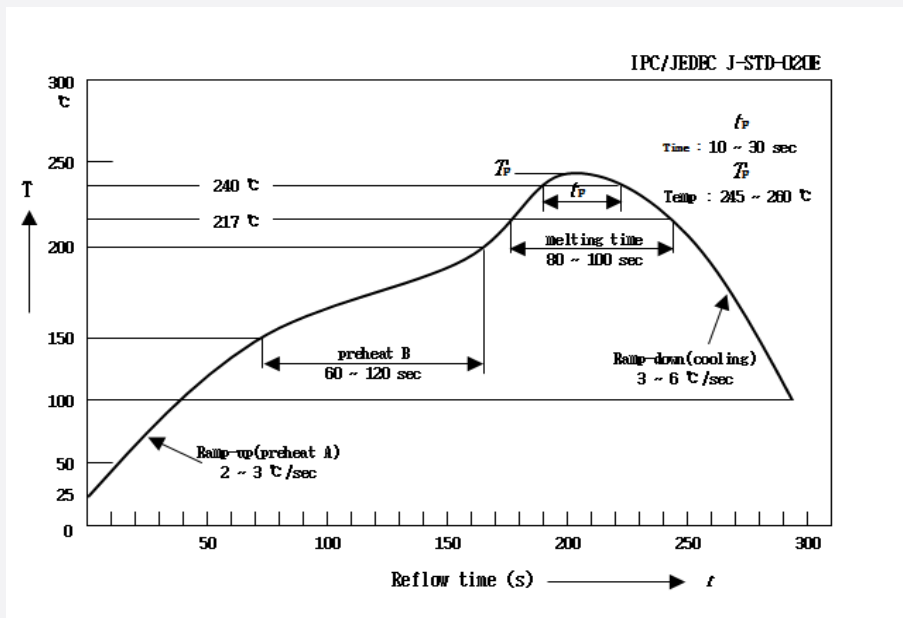

c) Manual Soldering Conditions

Not more than 5 seconds @ max 300 °C, under soldering iron. (One time only)

7. Tape & Reel

a) Taping Dimension

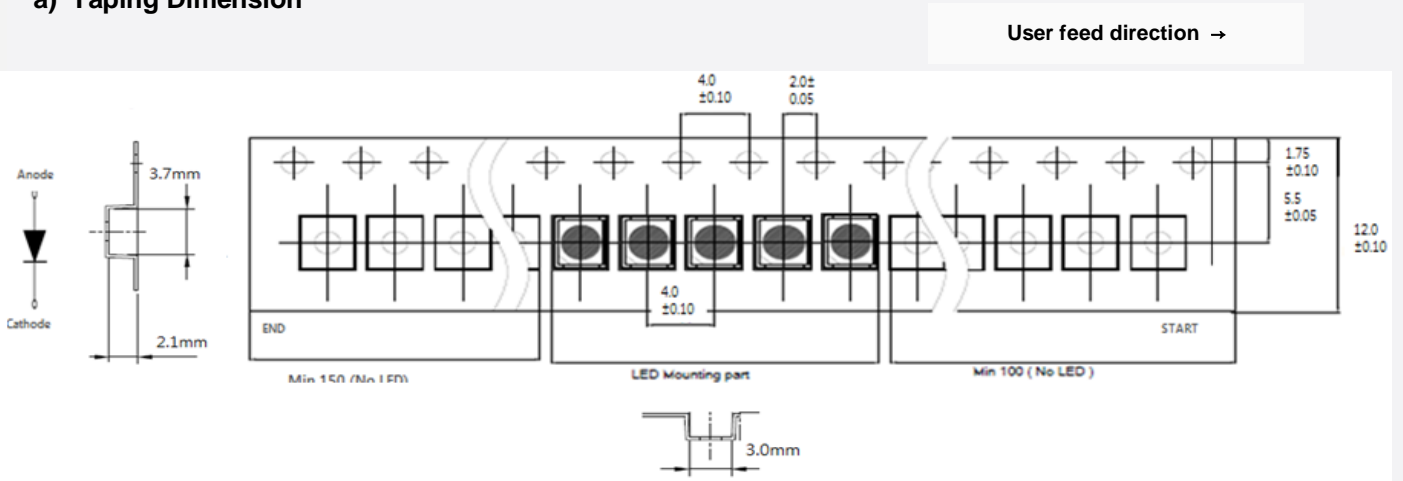

Note:

Unit: mm, LED taping quantity: 2,000EA / Reel

b) Reel Dimension

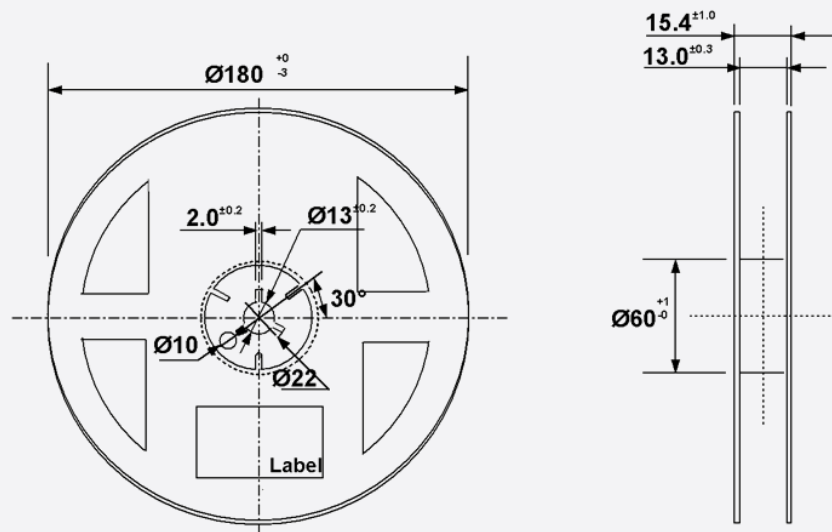

Notes:

Unit: mm, Tolerance: ±0.2mm

8. Label Structure

a) Product Labeling Information



N.B) Denoted rank is the only example.

b) Bin Code Structure

AB: Forward Voltage (V_F) Bin (refer to page. 5)

CD: Color bin (C_x, C_y) (refer to page. 6)

EF: Luminous Flux (I_v) Bin (refer to page. 5)

c) Lot Number Structure

The lot number is composed of the following characters:

No.	Information
1	Production Site : S:SAMSUNG LED, G:GOSIN CHINA
2	LED
3	Product State A :Normality, B :Bulk, C :First Production, R :Reproduction, S :Sample
4	Year : Y:2014, Z:2015, A:2016, B:2017, C:2018 ...
5	Month : 1 ~ 9, A, B
6	Day : 1 ~ 9, A, B ~ V
789	Product number : 1 ~ 999
abc	Reel Number : 1 ~ 999

9. Packing Structure

a) Packing Process

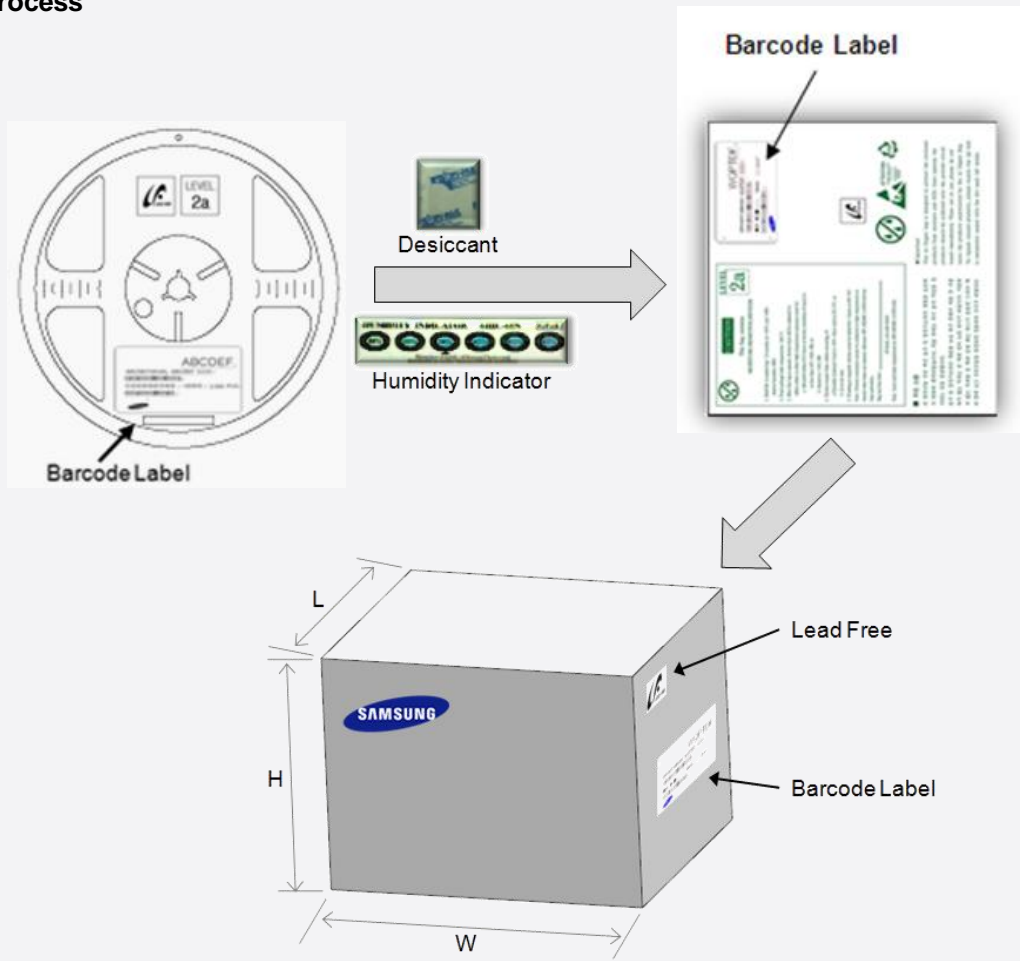

Dimension of Transportation Box in mm

Width	Length	Height
220	245	182

10. Handling and use precautions

- 1) For over-current protection, we recommend the use of resistors to prevent sudden current surges caused by slight shifts in voltage
- 2) LEDs should not be contacted to any type of fluid (i.e. water, oil, organic solvent, etc.). If cleaning is required, only use isopropyl alcohol.
- 3) The maximum ambient temperature must be considered in order for the maximum temperature ratings not to be exceeded.
- 4) LEDs must be stored in a clean environment. If the LEDs are to be stored for 3 months or more after being shipped from Samsung Electronics, they should be packed by a sealed container with nitrogen gas injected. (Shelf life of sealed bags: 12 months, temp. ~40°C, ~90% RH)
- 5) After storage bag is open, LED subjected to soldering, solder reflow, or other high temperature processes must be:
 - a. Mounted within 672 hours (28 days) at an assembly line with a condition of no more than 30°C / 60% RH.
 - b. Stored at <10% RH.
- 6) Repack unused products using anti-moisture packing, fold to close any openings and store in a dry place.
note: May want to add <10% RH or something here, i.e. “store in a dry place with <10% RH” or something like that, even though it’s also stated above in 5b, it should be re-iterated
- 7) LEDs require baking before mounting, if humidity card reading is >60% at 23±5°C.
- 8) If baking is required, LEDs must be baked for 1 day at 60±5°C
- 9) LEDs are sensitive to electrostatic discharge and surges. Applying any voltage exceeding the absolute maximum rating of the LED can cause permanent damage to the device. Damaged LEDs may have some unusual characteristics such as increased leakage current, lower turn-on voltage or may light abnormally at low current. When handling LEDs, using grounding wrist-bands or anti-static gloves is recommended.
- 10) VOCs (volatile organic compounds) present in adhesives, flux, hardeners or organic additives, etc. that are used in luminaires may lead to discoloration of the LED when exposed to heat or light. Note that VOCs can permeate silicone bags. This phenomenon can significantly affect light output from the luminaire. To avoid this issue, please carefully evaluate materials used in your process and/or luminaire to be free of VOCs.
- 11) To avoid risk of sulfurization (or tarnishing), do not use or store LEDs near materials containing sulfur, fluorine, chlorine, bromine, iodine or other halogens or compounds that can potentially react with the LED's silver plated lead frame. Examples of these materials include: various rubbers, paper products, certain solder pastes, cleaning solutions, adhesives, etc. or may be present in certain environments in form of fertilizers, lubricants, etc. This reaction can result into the lead frame darkening when exposed to such compounds, resulting in degradation of intensity, change in forward voltage, chromaticity coordinate shift and it may go as far as becoming an open circuit in more extreme cases.

1.1. Company Information

SAMSUNG

Copyright @1995-2020 All rights reserved
Samsung Electronics LED BUSINESS
 1, Samsung-ro Giheung-gu
 Yongin-si, Gyeonggi-do 17113 Korea

<http://www.samsung.com/led>
Sales Contact : cpim@samsung.com

US

Samsung Semiconductor, Inc.
 11800 Amber park Drive #225 Alpharetta, GA 30004 USA
 Tel : +1 678 892 7385

Europe

Samsung Semiconductor Europe GmbH
 Oskar-Messter-Strasse 29, 85737 Ismaning, Germany
 Tel : +49 6196 66 3902

Japan

Samsung Japan Corporation
 10F, Shinagawa Grand Central Tower 2-16-4, Kounan, Minato-ku, Tokyo
 108-8240, Japan
 Tel : +81 3 6369 6262

China(Shenzhen)

Samsung Electronics Co., Ltd.
 25F/26F, SCC building A, No.88, Haide Yi Road, Nanshan District, 518026,
 Shenzhen China
 Tel : +86 755 8608 5674

China(Shanghai)

Samsung Electronics Co., Ltd.
 Building B, No 1065 Zhongshan RD(W), Changning District, Shanghai,
 China
 Tel : +86 21 2325 3504

India

Samsung Electronics
 Suite #006 Ground Floor, Copia Corporate Suites, Jasola, New Delhi
 110025, India, Delhi, IND
 Tel : +91 9600003320

SAMSUNG

Legal and additional information.

[About Samsung Electronics Co., Ltd.](#)

Samsung inspires the world and shapes the future with transformative ideas and technologies. The company is redefining the worlds of TVs, smartphones, wearable devices, tablets, digital appliances, network systems, and memory, system LSI, foundry and LED solutions. For the latest news, please visit the Samsung Newsroom at news.samsung.com.

Copyright © 2018 Samsung Electronics Co., Ltd. All rights reserved.

Samsung is a registered trademark of Samsung Electronics Co., Ltd.

Specifications and designs are subject to change without notice. Non-metric weights and measurements are approximate. All data were deemed correct at time of creation. Samsung is not liable for errors or omissions. All brand, product, service names and logos are trademarks and/or registered trademarks of their respective owners and are hereby recognized and acknowledged.

Samsung Electronics Co., Ltd.

95, Samsung 2-ro

Giheung-gu

Yongin-si, Gyeonggi-do, 446-711

KOREA

www.samsungled.com

SAMSUNG