



1012GN-800V

800 Watts - 54 Volts, 20us, 6%
1025-1150 MHz

GENERAL DESCRIPTION

The 1012GN-800V is an internally matched, COMMON SOURCE, high power class AB GaN on SiC transistor specifically designed for 20us, 6% duty cycle radar systems. It provides over 19dB gain, 800 Watts of pulsed RF output power using 20us, 6% pulse format at 1025-1150MHz. The transistor has internal pre-match for optimal performance. This transistor is specifically designed for Avionics radar applications and uses gold metallization to provide highest reliability and superior ruggedness.

CASE OUTLINE 55-KR Common Source

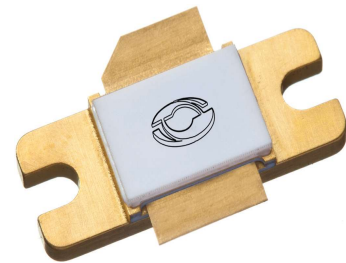

ABSOLUTE MAXIMUM RATINGS

Maximum Power Dissipation

Device Dissipation @ 25°C 1000 W

Maximum Voltage and Current

Drain-Source Voltage (V_{DSS}) 150 V

Gate-Source Voltage (V_{GS}) -8 to +0 V

Maximum Temperatures

Storage Temperature (T_{STG}) -55 to +125 °C

Operating Junction Temperature +200 °C

ELECTRICAL CHARACTERISTICS @ 25°C

Symbol	Characteristics	Test Conditions	Min	Typ	Max	Units
Pout	Output Power	Freq=1025-1150 MHz, 20us, 6%	800	825		W
Gp	Power Gain	Freq=1025-1150 MHz, 20us, 6%	19	19.3		dB
η_d	Drain Efficiency	Freq=1025-1150 MHz, 20us, 6%	53	58		%
R/L	Input Return Loss	Freq=1025-1150 MHz, 20us, 6%	-7	-8		dB
VSWR-T	Load Mismatch Tolerance	Pout=800W, Freq= 1150MHz			3:1	
Θ_{jc}	Thermal Resistance	Pulse Width=20uS, Duty=6%			0.21	°C/W

- Constant Gate Bias Condition: $V_{dd}=+54V$, $I_{dq}=120$ mA ($V_{gs}=-2.0 \sim -4.8V$ typical)

FUNCTIONAL CHARACTERISTICS @ 25°C

Symbol	Characteristics	Test Conditions	Min	Typ	Max	Units
$I_{D(off)}$	50 V Drain leakage current	$V_{gs} = -8V$, $V_D = 50V$			36*	mA
$I_{G(off)}$	Gate leakage current	$V_{gs} = -8V$, $V_D = 0V$			26*	mA
$I_{D(off)}$	150V Drain leakage current	$V_{gs} = -8V$, $V_D = 150V$			50*	mA

- DC parameters pass/failure criteria will be revised after mass production DC parameters distributions have been determined.

Issue April 2013



1012GN-800V

800 Watts - 54 Volts, 20us, 6%
1025-1150 MHz

TYPICAL RF PERFORMANCE DATA

Frequency	Pin (W)	Pout (W)	Id (A)	RL (dB)	Nd (%)	G (dB)	Droop (dB)
1030 MHz	10	841	1.65	-8.5	59.3	19.25	0.2
1090 MHz	10	885	1.64	-14	62.5	19.47	0.2
1150 MHz	10	1.52	-8.9	66.7	19.39	0.2	

Typical RF Performance Plots

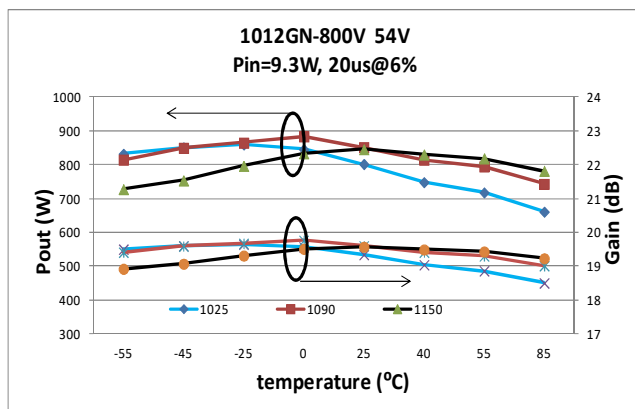
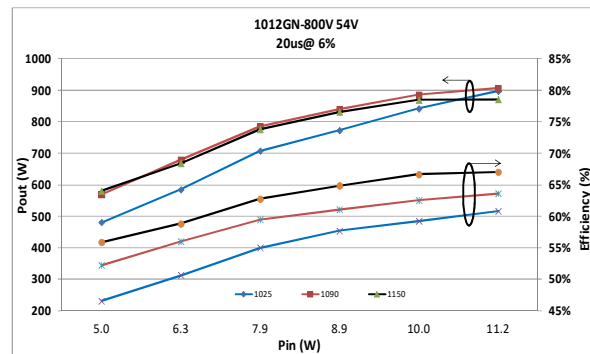
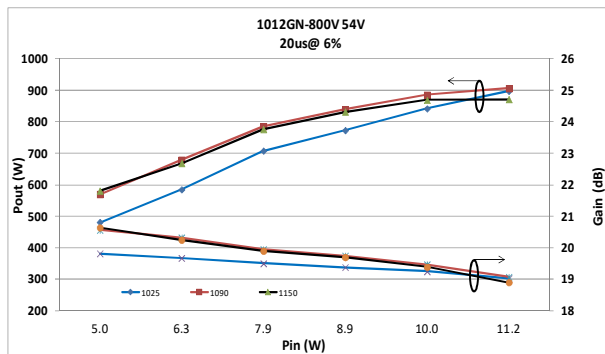



1012GN-800V

800 Watts - 54 Volts, 20us, 6%
1025-1150 MHz

Transistor Impedance Information

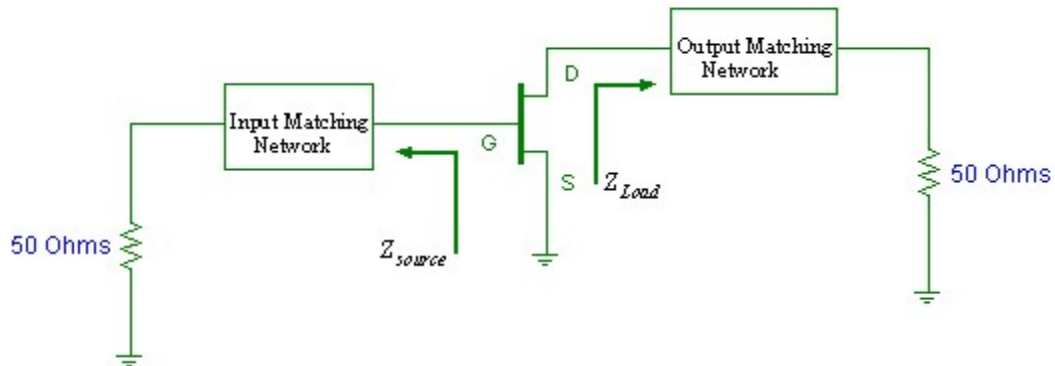

Note: Z_{in} is looking into the input circuit;
 Z_{Load} is looking into the output circuit.

Impedance Data		
Freq (GHz)	Zs	ZI
1.025	1.717 - j1.539	1.241 - j1.306
1.090	1.5 - j1.423	1.104 - j1.088
1.150	1.238 - j1.225	0.965 - j0.852



1012GN-800V

800 Watts - 54 Volts, 20us, 6%
1025-1150 MHz

Test Circuit Diagram

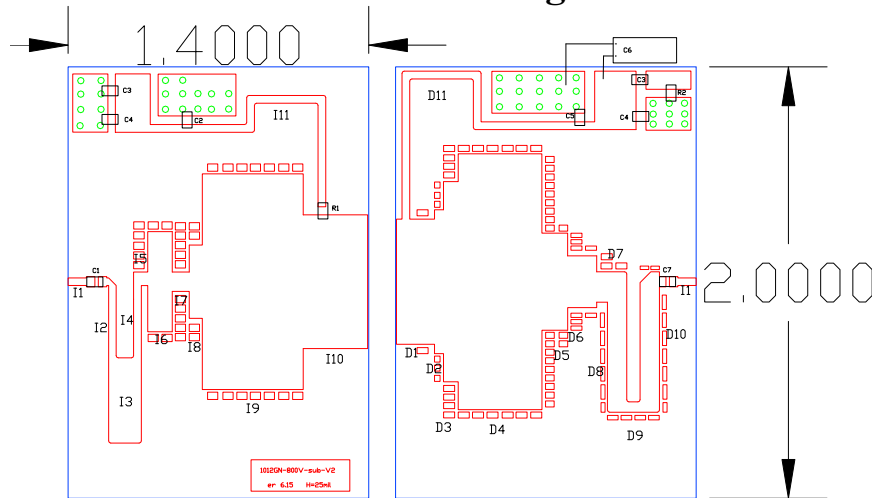

Board Material: Roger Duriod 6006 @ 25 Mil Thickness, Er=6.15

Component List			Input layout			Output layout		
Item	Description	Value	Item	W(mil)	L(mil)	Item	W(mil)	L(mil)
C1	ATC 800A	100pF	I1	36	85	D1	580	178
C2	ATC 100B	100PF	I2	370	36	D2	666	42
C3	ATC 100B	1000pF	I3	395	152	D3	928	69
C4	ATC 100B	1000pF	I4	336	36	D4	1198	390
C5	ATC 100B	91PF	I5	64	66	D5	450	120
C6	Elyctrylic Capacitor (160V)	1000UF	I6	462	114	D6	240	135
C7	ATC 600S	68PF	I7	90	65	D7	140	140
R1	0805	10 ohm	I8	340	60	D8	462	90
R2	0805	2.2ohm	I9	1012	468	D9	48	242
note	C3, C4 X2		I10	620	305	D10	603	90
C6 can be replace by large capacitor such as 6800uF (63V)			I11	36	1315	D11	36	1380-1600



1012GN-800V

800 Watts - 54 Volts, 20us, 6%
1025-1150 MHz

55-KR Package Dimension

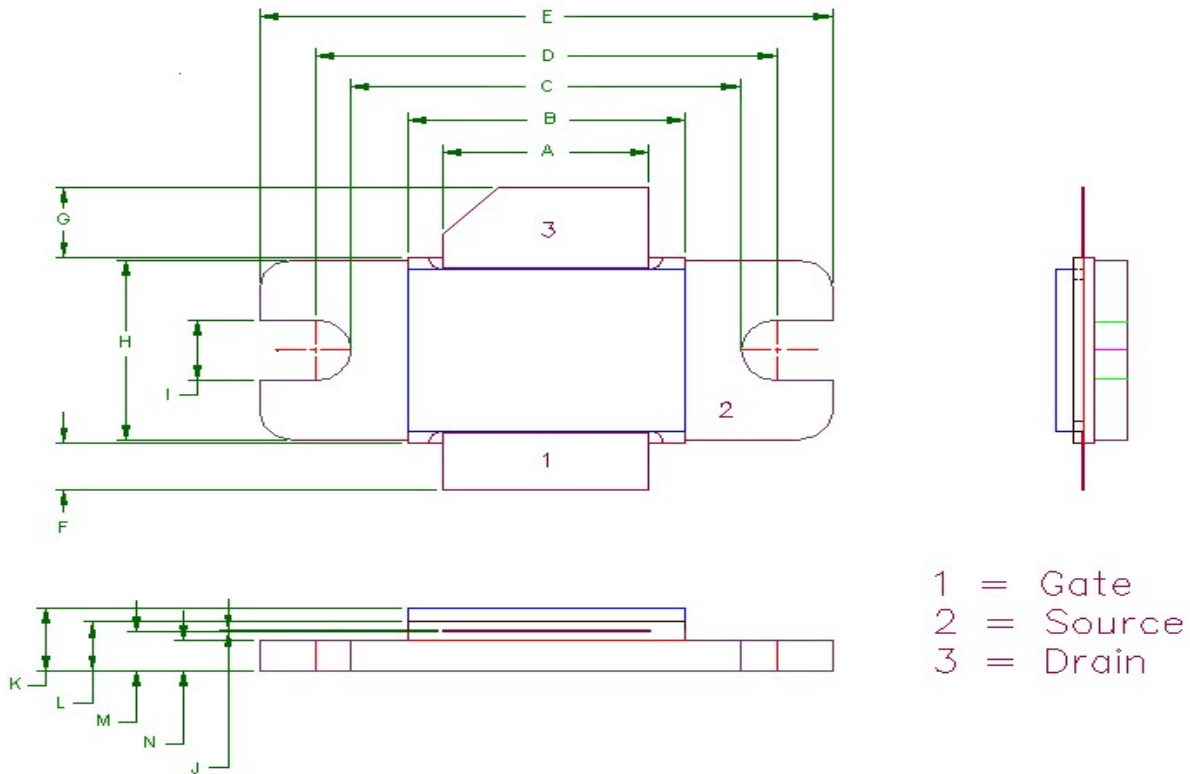

Dimension	Min (mil)	Min (mm)	Max (mil)	Max (mm)
A	370	9.40	372	9.44
B	498	12.65	500	12.7
C	700	17.78	702	17.83
D	830	21.08	832	21.13
E	1030	26.16	1032	26.21
F	101	2.56	102	2.59
G	151	3.84	152	3.86
H	385	9.78	387	9.83
I	130	3.30	132	3.35
J	003	.076	004	0.10
K	135	3.43	137	3.48
L	105	2.67	107	2.72
M	085	2.16	86	2.18
N	065	1.65	66	1.68