

## YASMEEN-30-RS

~11° spot beam. Variant with holder.

### SPECIFICATION:

Dimensions	Ø 32.0 mm
Height	18.9 mm
Fastening	tape, pin
ROHS compliant	yes ⓘ

### MATERIALS:

Component	Type	Material	Colour	Finish
YASMEEN-30-RS	Single lens	PMMA	clear	
OLGA-HLD	Holder	PC	black	
SPUTNIK-TAPE3	Tape	Acrylic foam	black	

### ORDERING INFORMATION:

Component		Qty in box	MOQ	MPQ	Box weight (kg)
CA17181_YASMEEN-30-RS	Single lens	792	132	66	7.7
» Box size: 480 x 280 x 300 mm					



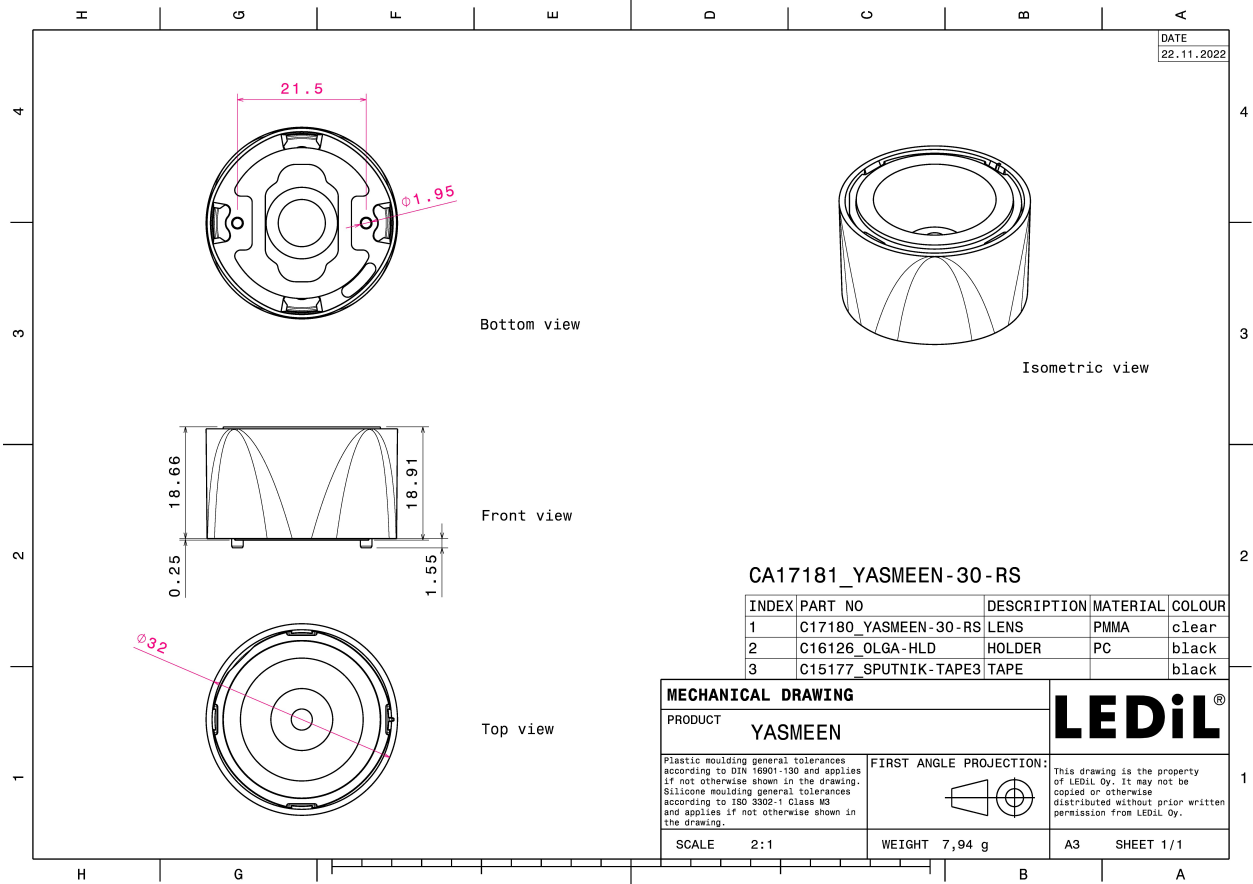

See also our general installation guide: [www.ledil.com/installation\\_guide](http://www.ledil.com/installation_guide)

#### OPTICAL RESULTS (MEASURED):



LED XHP35 HI  
FWHM / FWTM 12.0° / 23.0°  
Efficiency 88 %  
Peak intensity 14.4 cd/lm  
LEDs/each optic 1  
Light colour White  
Required components:

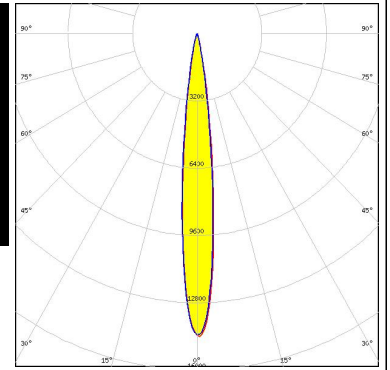
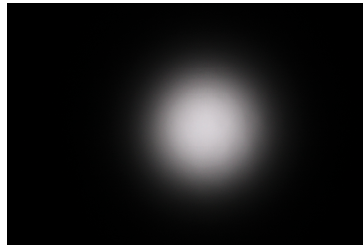

#### OPTICAL RESULTS (SIMULATED):

##### CREE LED

LED XHP35.2 HD  
 FWHM / FWTM 18.0° / 33.0°  
 Efficiency 86 %  
 Peak intensity 7.4 cd/lm  
 LEDs/each optic 1  
 Light colour White  
 Required components:

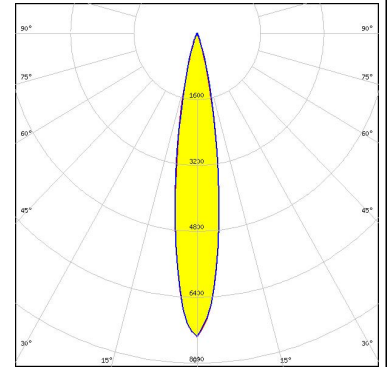

##### CREE LED

LED XHP70  
 FWHM / FWTM 26.0° / 49.0°  
 Efficiency 86 %  
 Peak intensity 3.3 cd/lm  
 LEDs/each optic 1  
 Light colour White  
 Required components:

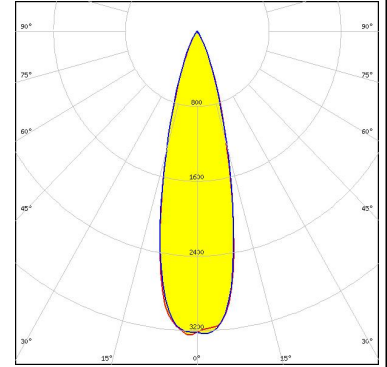

##### CREE LED

LED XHP70.3 HI  
 FWHM / FWTM 18.0° / 38.0°  
 Efficiency 87 %  
 Peak intensity 6 cd/lm  
 LEDs/each optic 1  
 Light colour White  
 Required components:

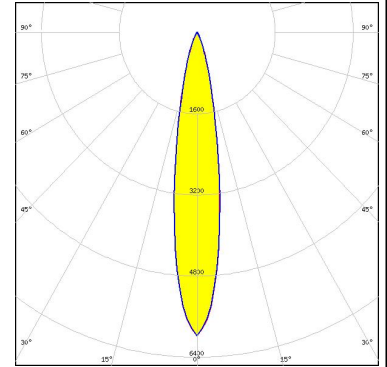

##### CREE LED

LED XM-L  
 FWHM / FWTM 14.0° / 28.0°  
 Efficiency 91 %  
 Peak intensity 11.4 cd/lm  
 LEDs/each optic 1  
 Light colour White  
 Required components:

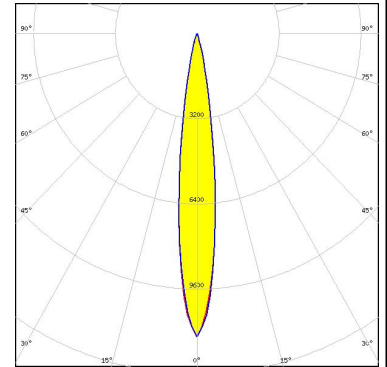

#### OPTICAL RESULTS (SIMULATED):

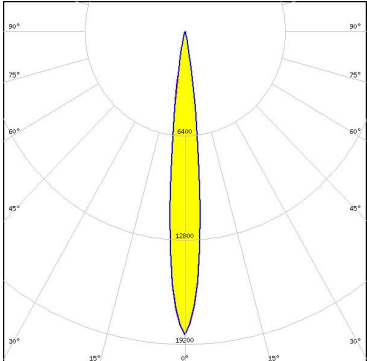
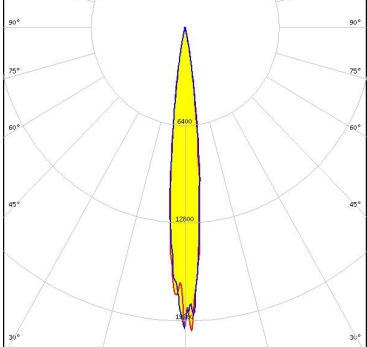
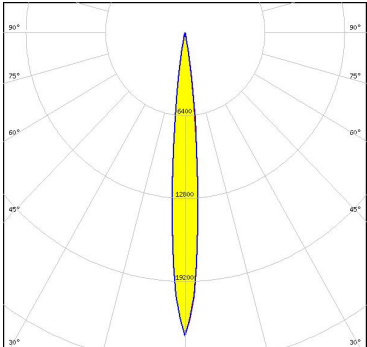
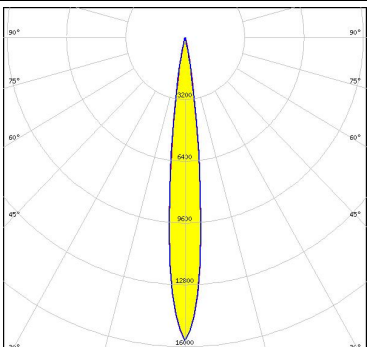
<p><b>CREE</b> LED</p> <p>LED: XP-E2            FWHM / FWTM: 12.0° / 22.0°            Efficiency: 92 %            Peak intensity: 18.6 cd/lm            LEDs/each optic: 1            Light colour: White            Required components:</p>	
<p><b>CREE</b> LED</p> <p>LED: XP-G2            FWHM / FWTM: 11.4° / 20.8°            Efficiency: 92 %            Peak intensity: 22.7 cd/lm            LEDs/each optic: 1            Light colour: White            Required components:</p>	
<p><b>CREE</b> LED</p> <p>LED: XP-P            FWHM / FWTM: 10.0° / 20.0°            Efficiency: 96 %            Peak intensity: 23.4 cd/lm            LEDs/each optic: 1            Light colour: White            Required components:</p>	
<p><b>LUMILEDS</b></p> <p>LED: LUXEON C            FWHM / FWTM: 12.0° / 22.0°            Efficiency: 86 %            Peak intensity: 15.7 cd/lm            LEDs/each optic: 1            Light colour: White            Required components:</p>	

#### OPTICAL RESULTS (SIMULATED):

<p><b>LUMILEDS</b></p> <p>LED: LUXEON CZ            FWHM / FWTM: 11.0° / 20.0°            Efficiency: 92 %            Peak intensity: 19.8 cd/lm            LEDs/each optic: 1            Light colour: White            Required components:</p>	
<p><b>NICHIA</b></p> <p>LED: NCSxE17A            FWHM / FWTM: 10.0° / 24.0°            Efficiency: 88 %            Peak intensity: 14.5 cd/lm            LEDs/each optic: 1            Light colour: White            Required components:</p>	
<p><b>NICHIA</b></p> <p>LED: NV4WB35AM            FWHM / FWTM: 14.0° / 30.0°            Efficiency: 91 %            Peak intensity: 10.1 cd/lm            LEDs/each optic: 1            Light colour: White            Required components:</p>	
<p><b>NICHIA</b></p> <p>LED: NV4WB35AM            FWHM / FWTM: 14.0° / 30.0°            Efficiency: 91 %            Peak intensity: 10.1 cd/lm            LEDs/each optic: 1            Light colour: White            Required components:</p>	

#### OPTICAL RESULTS (SIMULATED):

<p><b>NICHIA</b></p> <p>LED: NV4x144A            FWHM / FWTM: 20.0° / 38.0°            Efficiency: 88 %            Peak intensity: 5.8 cd/lm            LEDs/each optic: 1            Light colour: White            Required components:</p>	
<p><b>NICHIA</b></p> <p>LED: NVSxE21A            FWHM / FWTM: 12.0° / 28.0°            Efficiency: 89 %            Peak intensity: 12.1 cd/lm            LEDs/each optic: 1            Light colour: White            Required components:</p>	
<p><b>OSRAM</b>  <small>Opto Semiconductors</small></p> <p>LED: OSCONIQ P 3737 (3W version)            FWHM / FWTM: 14.0° / 28.0°            Efficiency: 91 %            Peak intensity: 11.8 cd/lm            LEDs/each optic: 1            Light colour: White            Required components:</p>	
<p><b>OSRAM</b>  <small>Opto Semiconductors</small></p> <p>LED: OSOLON Square CSSRM2/CSSRM3            FWHM / FWTM: 12.0° / 24.0°            Efficiency: 91 %            Peak intensity: 15.8 cd/lm            LEDs/each optic: 1            Light colour: White            Required components:</p>	

#### OPTICAL RESULTS (SIMULATED):

### SAMSUNG

LED LH151B  
 FWHM / FWTM 16.0° / 39.0°  
 Efficiency 88 %  
 Peak intensity 6.1 cd/lm  
 LEDs/each optic 4  
 Light colour White  
 Required components:

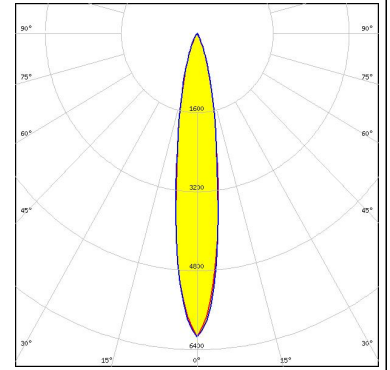

### SAMSUNG

LED LH351C  
 FWHM / FWTM 10.0° / 20.0°  
 Efficiency 94 %  
 Peak intensity 21.7 cd/lm  
 LEDs/each optic 1  
 Light colour White  
 Required components:

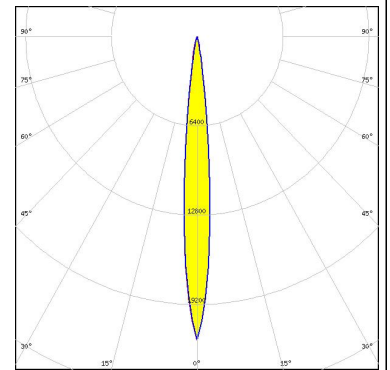

### SAMSUNG

LED LH351D  
 FWHM / FWTM 12.0° / 24.0°  
 Efficiency 92 %  
 Peak intensity 14.2 cd/lm  
 LEDs/each optic 1  
 Light colour White  
 Required components:

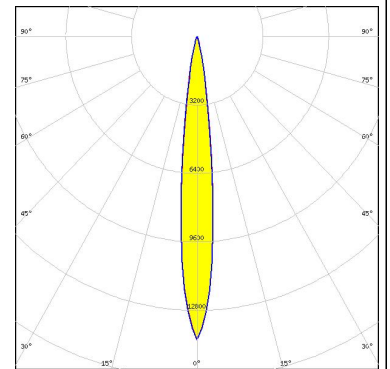



### GENERAL INFORMATION:

NOTE: The typical beam angle will be changed by different color, chip size and chip position tolerance. The typical total beam angle is the full angle measured where the luminous intensity is half of the peak value.

### MATERIALS:

As part of our continuous research and improvement processes, and to ensure the best possible quality and availability of our products, LEDiL reserves the right to change material grades without notice.

### PRODUCT DATA USER AGREEMENT AND DISCLAIMER:

The measured data in the provided downloadable LEDiL Product Datasheets and Mechanical 2D-Drawings is rounded and provided as reference for planning. LEDiL Oy's optical specifications have been verified by conducting performance testing of the products in accordance with the company's quality system. The reported data are averaged results of multiple measurements with typical variation. LEDiL Oy reserves the right to without prior notification make changes and improvements to its products.

LEDiL Oy assumes neither warranty, nor guarantee nor any other liability of any kind for the contents and correctness of the provided data. The provided data has been generated with highest diligence but the provided data may in reality not represent the complete possible variation range of all intrinsic parameters. Therefore, in certain cases a deviation from the provided data could occur.

LEDiL Oy reserves the right to undertake technical changes of its products without further notification which could lead to changes in the provided data. LEDiL Oy assumes no liability of any kind for the possible deviation from any provided data or any other damage resulting from the usage of the provided data.

The user agrees to this disclaimer and user agreement with the download or usage of the provided files.

#### LEDiL Oy

Joensuunkatu 13  
FI-24240 SALO  
Finland

#### LEDiL Inc.

228 West Page Street  
Suite D  
Sycamore IL 60178  
USA

#### Ledil Optics Technology (Shenzhen) Co., Ltd.

# 405 , Block B  
Casic Motor Building  
Shenzhen 518057  
P.R.CHINA

#### Local sales and technical support

[www.ledil.com/  
where\\_to\\_buy](http://www.ledil.com/where_to_buy)

#### Shipping locations

Salo, Finland  
Hong Kong, China

#### Distribution Partners

[www.ledil.com/  
where\\_to\\_buy](http://www.ledil.com/where_to_buy)