

# Silicon Carbide (SiC) Schottky Diode – EliteSiC, 50 A, 1200 V, D3, TO-247-2L

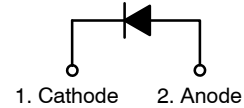

Schottky Diode

## NDSH50120C

### Description

Silicon Carbide (SiC) Schottky Diodes use a completely new technology that provides superior switching performance and higher reliability compared to Silicon. No reverse recovery current, temperature independent switching characteristics, and excellent thermal performance sets Silicon Carbide as the next generation of power semiconductor. System benefits include highest efficiency, faster operating frequency, increased power density, reduced EMI, and reduced system size and cost.

### Features

- Max Junction Temperature 175°C
- Avalanche Rated 380 mJ
- High Surge Current Capacity
- Positive Temperature Coefficient
- Ease of Paralleling
- No Reverse Recovery / No Forward Recovery
- These Devices are Halogen Free/BFR Free and are RoHS Compliant

### Applications

- General Purpose
- SMPS, Solar Inverter, UPS
- Power Switching Circuits

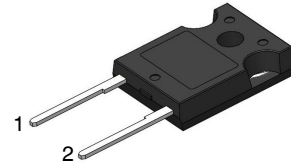

TO-247-2LD  
 CASE 340DA

### MARKING DIAGRAM

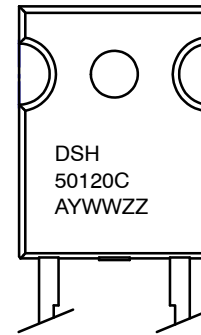

|           |                           |
|-----------|---------------------------|
| DSH50120C | = Specific Device Code    |
| A         | = Assembly Plant Code     |
| YWW       | = Date Code (Year & Week) |
| ZZ        | = Lot Code                |

### ORDERING INFORMATION

See detailed ordering and shipping information on page 2 of this data sheet.

# NDSH50120C

## ABSOLUTE MAXIMUM RATINGS (T<sub>J</sub> = 25°C unless otherwise noted)

| Symbol                            | Parameter   | Value                                    | Unit |   |
|-----------------------------------|---|--|------|---|
| V <sub>RRM</sub>                  | Peak Repetitive Reverse Voltage                               | 1200                                     | V    |   |
| E <sub>AS</sub>                   | Single Pulse Avalanche Energy (Note 1)                        | 380                                      | mJ   |   |
| I <sub>F</sub>                    | Continuous Rectified Forward Current @ T <sub>C</sub> < 139°C | 50                                       | A    |   |
|                                   | Continuous Rectified Forward Current @ T <sub>C</sub> < 135°C | 53                                       |      |   |
| I <sub>F, Max</sub>               | Non-Repetitive Peak Forward Surge Current                     | T <sub>C</sub> = 25°C, 10 μs             | 1568 | A |
|                                   |   | T <sub>C</sub> = 150°C, 10 μs            | 1414 | A |
| I <sub>F, SM</sub>                | Non-Repetitive Forward Surge Current                          | Half-Sine Pulse, t <sub>p</sub> = 8.3 ms | 231  | A |
| I <sub>F, RM</sub>                | Repetitive Forward Surge Current                              | Half-Sine Pulse, t <sub>p</sub> = 8.3 ms | 84   | A |
| P <sub>tot</sub>                  | Power Dissipation   | T <sub>C</sub> = 25°C                    | 375  | W |
|                                   |   | T <sub>C</sub> = 150°C                   | 62.5 | W |
| T <sub>J</sub> , T <sub>STG</sub> | Operating and Storage Temperature Range                       | -55 to +175                              | °C   |   |

Stresses exceeding those listed in the Maximum Ratings table may damage the device. If any of these limits are exceeded, device functionality should not be assumed, damage may occur and reliability may be affected.

1. E<sub>AS</sub> of 380 mJ is based on starting T<sub>J</sub> = 25°C, L = 0.5 mH, I<sub>AS</sub> = 39 A, V = 50 V.

## THERMAL CHARACTERISTICS

| Symbol           | Parameter                                    | Value | Unit |
|------------------|--|-------|------|
| R <sub>θJC</sub> | Thermal Resistance, Junction to Case, Max    | 0.4   | °C/W |
| R <sub>θJA</sub> | Thermal Resistance, Junction to Ambient, Max | 40    | °C/W |

## ELECTRICAL CHARACTERISTICS (T<sub>J</sub> = 25°C unless otherwise noted)

| Symbol         | Parameter               | Test Condition                                  | Min | Typ  | Max  | Unit |
|----------------|-------------------------|---|-----|------|------|------|
| V <sub>F</sub> | Forward Voltage         | I <sub>F</sub> = 50 A, T <sub>J</sub> = 25°C    | -   | 1.4  | 1.75 | V    |
|                |                         | I <sub>F</sub> = 50 A, T <sub>J</sub> = 125°C   | -   | 1.63 | -    |      |
|                |                         | I <sub>F</sub> = 50 A, T <sub>J</sub> = 175°C   | -   | 1.84 | -    |      |
| I <sub>R</sub> | Reverse Current         | V <sub>R</sub> = 1200 V, T <sub>J</sub> = 25°C  | -   | 12.2 | 200  | μA   |
|                |                         | V <sub>R</sub> = 1200 V, T <sub>J</sub> = 125°C | -   | 30   | 200  |      |
|                |                         | V <sub>R</sub> = 1200 V, T <sub>J</sub> = 175°C | -   | 61.5 | 200  |      |
| Q <sub>C</sub> | Total Capacitive Charge | V = 800 V                                       | -   | 246  | -    | nC   |
| C              | Total Capacitance       | V <sub>R</sub> = 1 V, f = 100 kHz               | -   | 3691 | -    | pF   |
|                |                         | V <sub>R</sub> = 400 V, f = 100 kHz             | -   | 198  | -    |      |
|                |                         | V <sub>R</sub> = 800 V, f = 100 kHz             | -   | 143  | -    |      |

Product parametric performance is indicated in the Electrical Characteristics for the listed test conditions, unless otherwise noted. Product performance may not be indicated by the Electrical Characteristics if operated under different conditions.

## ORDERING INFORMATION

| Part Number | Top Marking | Package                                | Shipping        |
|-------------|-------------|--|-----------------|
| NDSH50120C  | DSH50120C   | TO-247-2LD<br>(Pb-Free / Halogen Free) | 30 Units / Tube |

TYPICAL CHARACTERISTICS ( $T_J = 25^\circ\text{C}$  UNLESS OTHERWISE NOTED)

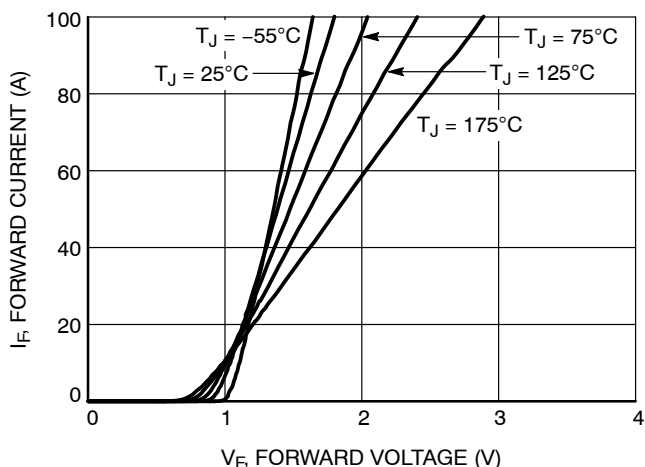

Figure 1. Forward Characteristics

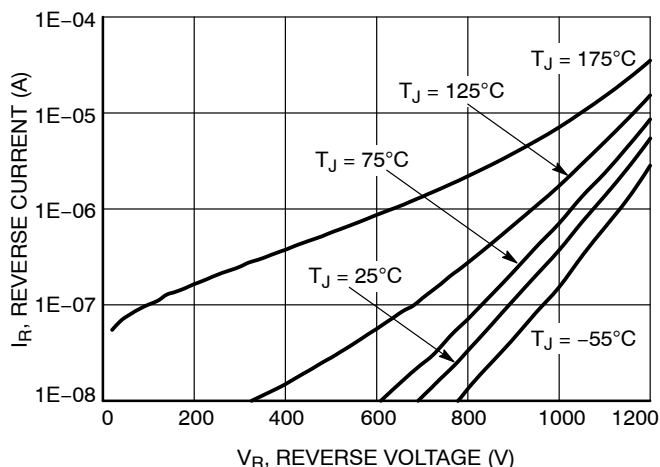

Figure 2. Reverse Characteristics

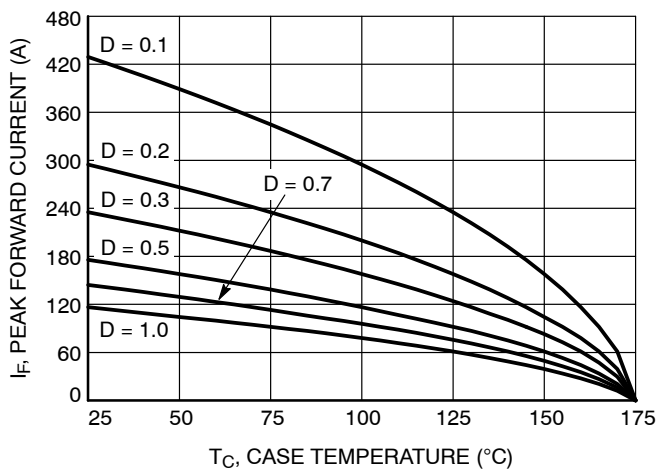

Figure 3. Current Derating

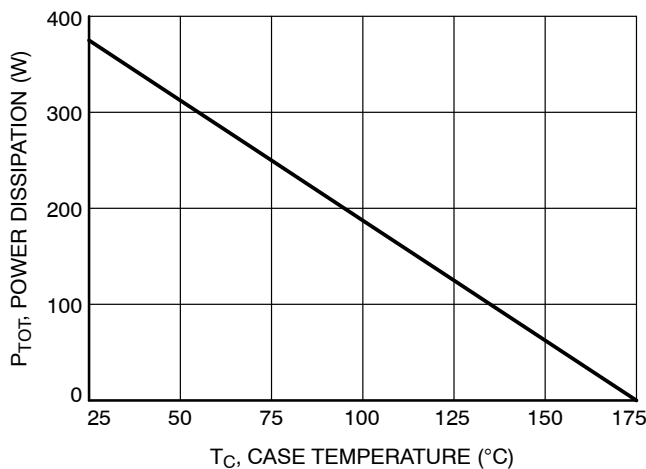

Figure 4. Power Derating

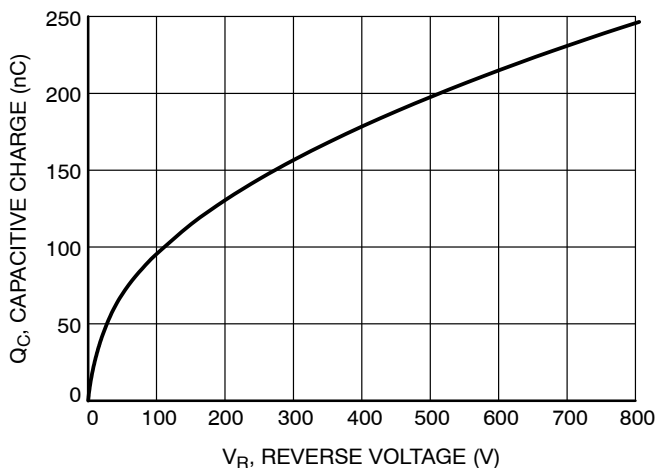

Figure 5. Capacitive Charge vs. Reverse Voltage

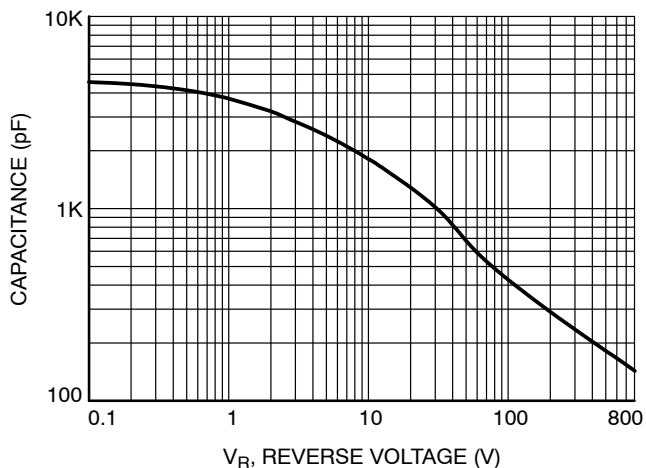

Figure 6. Capacitive vs. Reverse Voltage

TYPICAL CHARACTERISTICS ( $T_J = 25^\circ\text{C}$  UNLESS OTHERWISE NOTED)

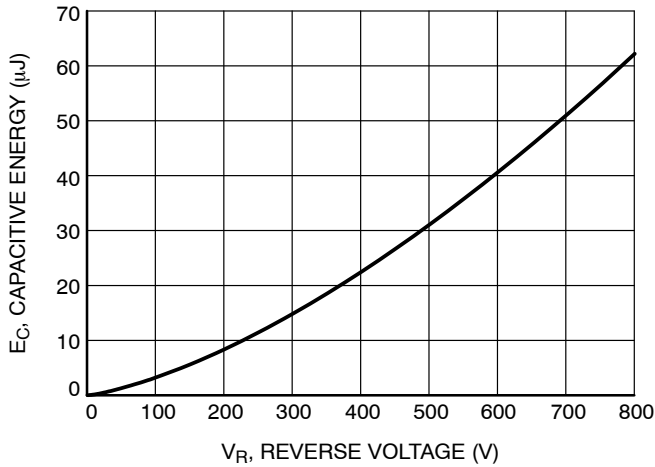

Figure 7. Capacitance Stored Energy

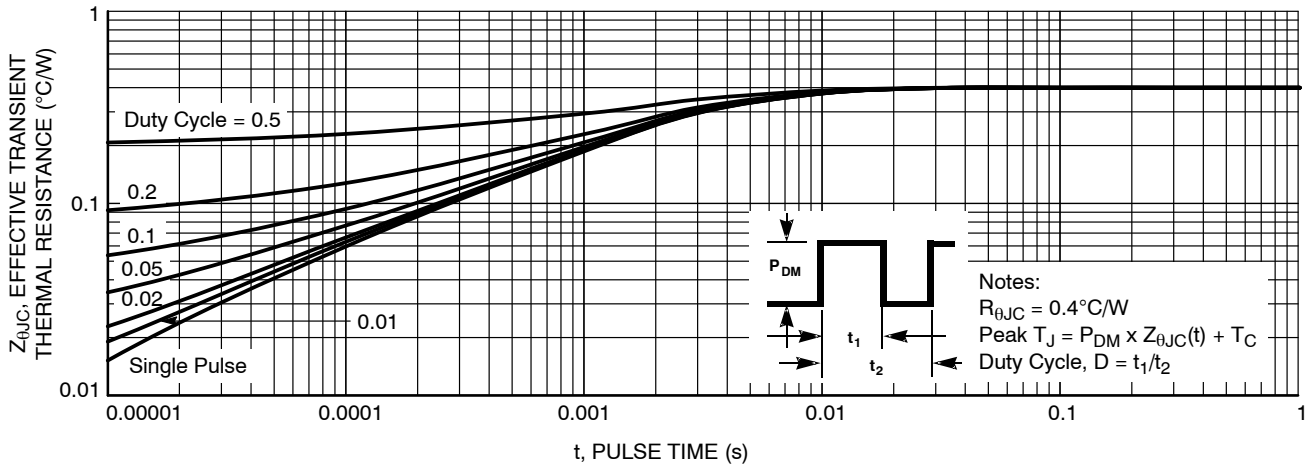

Figure 8. Junction-to-Case Transient Thermal Response Curve

# MECHANICAL CASE OUTLINE

## PACKAGE DIMENSIONS

ON Semiconductor®



### TO-247-2LD CASE 340DA ISSUE A

DATE 27 FEB 2019

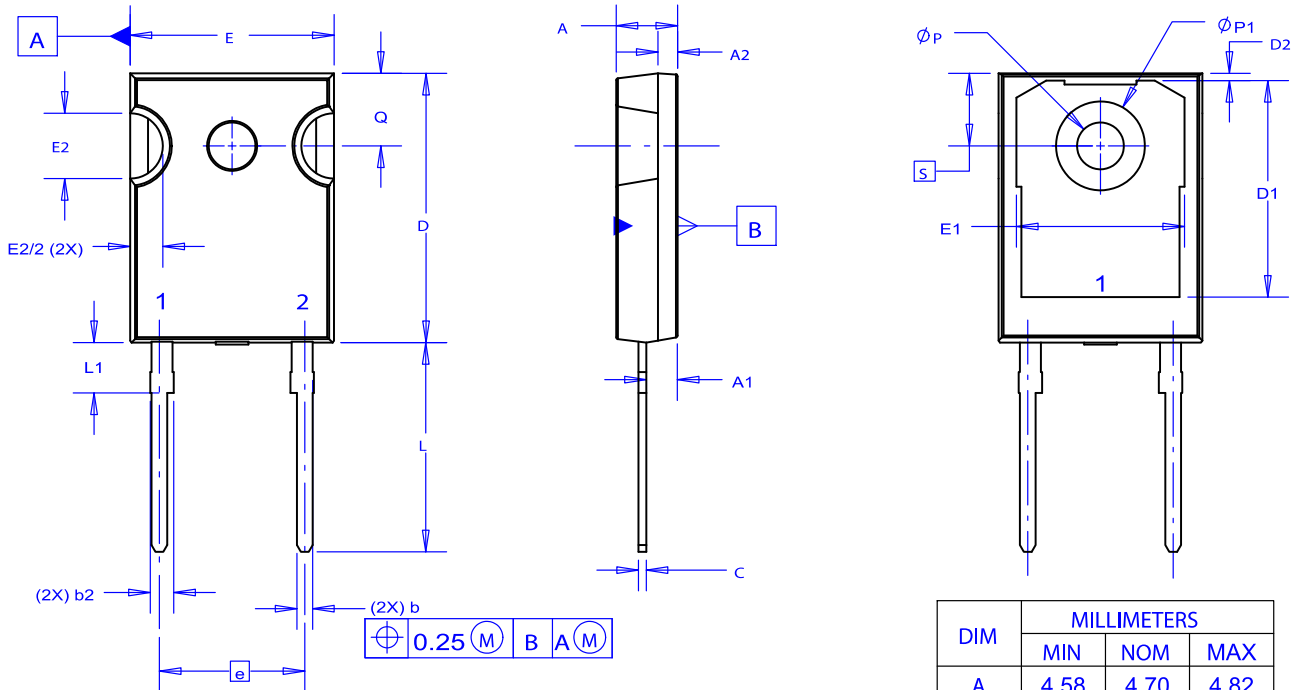

NOTES: UNLESS OTHERWISE SPECIFIED.

- A. DIMENSIONS ARE EXCLUSIVE OF BURRS, MOLD FLASH, AND TIE BAR EXTRUSIONS.
- B. ALL DIMENSIONS ARE IN MILLIMETERS.
- C. DRAWING CONFORMS TO ASME Y14.5 - 2009.
- D. DIMENSION A1 TO BE MEASURED IN THE REGION DEFINED BY L1.
- E. LEAD FINISH IS UNCONTROLLED IN THE REGION DEFINED BY L1.

| DIM | MILLIMETERS |       |       |
|-----|-------------|-------|-------|
|     | MIN         | NOM   | MAX   |
| A   | 4.58        | 4.70  | 4.82  |
| A1  | 2.20        | 2.40  | 2.60  |
| A2  | 1.40        | 1.50  | 1.60  |
| b   | 1.17        | 1.26  | 1.35  |
| b2  | 1.53        | 1.65  | 1.77  |
| c   | 0.51        | 0.61  | 0.71  |
| D   | 20.32       | 20.57 | 20.82 |
| D1  | 13.08       | ~     | ~     |
| D2  | 0.51        | 0.93  | 1.35  |
| E   | 15.37       | 15.62 | 15.87 |
| E1  | 12.81       | ~     | ~     |
| E2  | 4.96        | 5.08  | 5.20  |
| e   | ~           | 11.12 | ~     |
| L   | 15.75       | 16.00 | 16.25 |
| L1  | 3.69        | 3.81  | 3.93  |
| ØP  | 3.51        | 3.58  | 3.65  |
| ØP1 | 6.60        | 6.80  | 7.00  |
| Q   | 5.34        | 5.46  | 5.58  |
| S   | 5.34        | 5.46  | 5.58  |

### GENERIC MARKING DIAGRAM\*

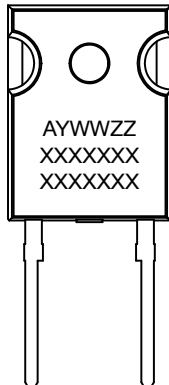

- XXXXX = Specific Device Code
- A = Assembly Location
- Y = Year
- WW = Work Week
- ZZ = Assembly Lot Code

\*This information is generic. Please refer to device data sheet for actual part marking. Pb-Free indicator, "G" or microdot "•", may or may not be present. Some products may not follow the Generic Marking.

|                         |                    |  |
|-------------------------|--------------------|--|
| <b>DOCUMENT NUMBER:</b> | <b>98AON00714H</b> | Electronic versions are uncontrolled except when accessed directly from the Document Repository. Printed versions are uncontrolled except when stamped "CONTROLLED COPY" in red. |
| <b>DESCRIPTION:</b>     | <b>TO-247-2LD</b>  | <b>PAGE 1 OF 1</b>   |

ON Semiconductor and are trademarks of Semiconductor Components Industries, LLC dba ON Semiconductor or its subsidiaries in the United States and/or other countries. ON Semiconductor reserves the right to make changes without further notice to any products herein. ON Semiconductor makes no warranty, representation or guarantee regarding the suitability of its products for any particular purpose, nor does ON Semiconductor assume any liability arising out of the application or use of any product or circuit, and specifically disclaims any and all liability, including without limitation special, consequential or incidental damages. ON Semiconductor does not convey any license under its patent rights nor the rights of others.

**onsemi**, **Onsemi**, and other names, marks, and brands are registered and/or common law trademarks of Semiconductor Components Industries, LLC dba "**onsemi**" or its affiliates and/or subsidiaries in the United States and/or other countries. **onsemi** owns the rights to a number of patents, trademarks, copyrights, trade secrets, and other intellectual property. A listing of **onsemi**'s product/patent coverage may be accessed at [www.onsemi.com/site/pdf/Patent-Marking.pdf](http://www.onsemi.com/site/pdf/Patent-Marking.pdf). **onsemi** reserves the right to make changes at any time to any products or information herein, without notice. The information herein is provided "as-is" and **onsemi** makes no warranty, representation or guarantee regarding the accuracy of the information, product features, availability, functionality, or suitability of its products for any particular purpose, nor does **onsemi** assume any liability arising out of the application or use of any product or circuit, and specifically disclaims any and all liability, including without limitation special, consequential or incidental damages. Buyer is responsible for its products and applications using **onsemi** products, including compliance with all laws, regulations and safety requirements or standards, regardless of any support or applications information provided by **onsemi**. "Typical" parameters which may be provided in **onsemi** data sheets and/or specifications can and do vary in different applications and actual performance may vary over time. All operating parameters, including "Typicals" must be validated for each customer application by customer's technical experts. **onsemi** does not convey any license under any of its intellectual property rights nor the rights of others. **onsemi** products are not designed, intended, or authorized for use as a critical component in life support systems or any FDA Class 3 medical devices or medical devices with a same or similar classification in a foreign jurisdiction or any devices intended for implantation in the human body. Should Buyer purchase or use **onsemi** products for any such unintended or unauthorized application, Buyer shall indemnify and hold **onsemi** and its officers, employees, subsidiaries, affiliates, and distributors harmless against all claims, costs, damages, and expenses, and reasonable attorney fees arising out of, directly or indirectly, any claim of personal injury or death associated with such unintended or unauthorized use, even if such claim alleges that **onsemi** was negligent regarding the design or manufacture of the part. **onsemi** is an Equal Opportunity/Affirmative Action Employer. This literature is subject to all applicable copyright laws and is not for resale in any manner.

## ADDITIONAL INFORMATION

### TECHNICAL PUBLICATIONS:

Technical Library: [www.onsemi.com/design/resources/technical-documentation](http://www.onsemi.com/design/resources/technical-documentation)  
onsemi Website: [www.onsemi.com](http://www.onsemi.com)

### ONLINE SUPPORT: [www.onsemi.com/support](http://www.onsemi.com/support)

For additional information, please contact your local Sales Representative at [www.onsemi.com/support/sales](http://www.onsemi.com/support/sales)