

# Si/SiC Hybrid Module – EliteSiC, Split T-Type NPC Inverter, Q2 Package

## NXH200T120H3Q2F2STNG

The NXH200T120H3Q2F2STNG is a power module containing a split T-type neutral point clamped three-level inverter. The integrated field stop trench IGBTs and SiC Diodes provide lower conduction losses and switching losses, enabling designers to achieve high efficiency and superior reliability.

### Features

- Split T-type Neutral Point Clamped Three-level Inverter Module
- 1200 V Ultra Field Stop IGBTs & 650 V FS4 IGBTs
- 650 V SiC Diodes
- Low Inductive Layout
- Solderable Pins
- Thermistor
- Pre-applied Thermal Interface Material (TIM) (optional)
- Nickel Plated DBC

### Typical Applications

- Solar Inverters
- Uninterruptible Power Supplies

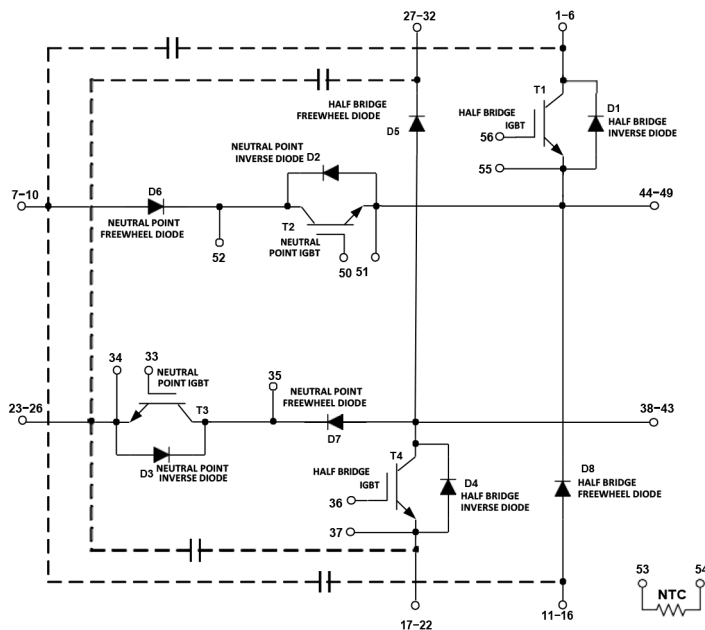
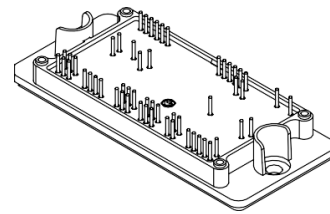
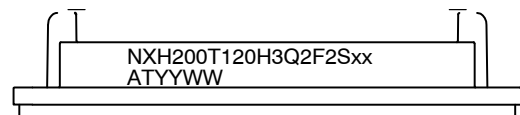

Figure 1. NXH200T120H3Q2F2STNG Schematic Diagram



PIM56, 93x47 (SOLDER PIN)  
CASE 180AK

### MARKING DIAGRAM



NXH200T120H3Q2F2Sxxx = Device Code  
YYWW = Year and Work Week Code  
A = Assembly Site Code  
T = Test Side Code  
G = Pb-Free Package

### PIN CONNECTIONS

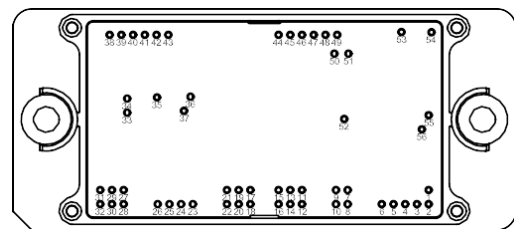

### ORDERING INFORMATION

See detailed ordering and shipping information on page 6 of this data sheet.

# NXH200T120H3Q2F2STNG

**Table 1. ABSOLUTE MAXIMUM RATINGS** (Note 1) ( $T_J = 25^\circ\text{C}$  unless otherwise noted)

Rating	Symbol	Value	Unit
<b>HALF BRIDGE IGBT</b>			
Collector–Emitter Voltage	V <sub>CES</sub>	1200	V
Gate–Emitter Voltage	V <sub>GE</sub>	±20	V
Continuous Collector Current @ $T_C = 25^\circ\text{C}$	I <sub>C</sub>	330	A
Continuous Collector Current @ $T_C = 80^\circ\text{C}$ ( $T_J = 175^\circ\text{C}$ )		256	
Pulsed Collector Current ( $T_J = 175^\circ\text{C}$ )	I <sub>Cpulse</sub>	768	A
Maximum Power Dissipation @ $T_C = 80^\circ\text{C}$ ( $T_J = 175^\circ\text{C}$ )	P <sub>tot</sub>	679	W
Minimum Operating Junction Temperature	T <sub>JMIN</sub>	–40	°C
Maximum Operating Junction Temperature	T <sub>JMAX</sub>	175	°C
<b>NEUTRAL POINT IGBT</b>			
Collector–Emitter Voltage	V <sub>CES</sub>	650	V
Gate–Emitter Voltage	V <sub>GE</sub>	±20	V
Continuous Collector Current @ $T_C = 80^\circ\text{C}$ ( $T_J = 175^\circ\text{C}$ )	I <sub>C</sub>	128	A
Pulsed Collector Current ( $T_J = 175^\circ\text{C}$ )	I <sub>Cpulse</sub>	384	A
Maximum Power Dissipation @ $T_C = 80^\circ\text{C}$ ( $T_J = 175^\circ\text{C}$ )	P <sub>tot</sub>	264	W
Minimum Operating Junction Temperature	T <sub>JMIN</sub>	–40	°C
Maximum Operating Junction Temperature	T <sub>JMAX</sub>	175	°C
<b>HALF BRIDGE FREEWHEEL DIODE</b>			
Peak Repetitive Reverse Voltage	V <sub>RRM</sub>	1200	V
Continuous Forward Current @ $T_C = 80^\circ\text{C}$ ( $T_J = 175^\circ\text{C}$ )	I <sub>F</sub>	94	A
Repetitive Peak Forward Current ( $T_J = 175^\circ\text{C}$ , $t_p$ limited by $T_{Jmax}$ )	I <sub>FRM</sub>	282	A
Maximum Power Dissipation @ $T_C = 80^\circ\text{C}$ ( $T_J = 175^\circ\text{C}$ )	P <sub>tot</sub>	232	W
Minimum Operating Junction Temperature	T <sub>JMIN</sub>	–40	°C
Maximum Operating Junction Temperature	T <sub>JMAX</sub>	175	°C
<b>HALF BRIDGE INVERSE DIODE</b>			
Peak Repetitive Reverse Voltage	V <sub>RRM</sub>	1200	V
Continuous Forward Current @ $T_C = 80^\circ\text{C}$ ( $T_J = 175^\circ\text{C}$ )	I <sub>F</sub>	18	A
Repetitive Peak Forward Current ( $T_J = 175^\circ\text{C}$ , $t_p$ limited by $T_{Jmax}$ )	I <sub>FRM</sub>	54	A
Maximum Power Dissipation @ $T_C = 80^\circ\text{C}$ ( $T_J = 175^\circ\text{C}$ )	P <sub>tot</sub>	62	W
Minimum Operating Junction Temperature	T <sub>JMIN</sub>	–40	°C
Maximum Operating Junction Temperature	T <sub>JMAX</sub>	175	°C
<b>NEUTRAL POINT FREEWHEEL DIODE</b>			
Peak Repetitive Reverse Voltage	V <sub>RRM</sub>	650	V
Continuous Forward Current @ $T_C = 80^\circ\text{C}$ ( $T_J = 175^\circ\text{C}$ )	I <sub>F</sub>	75	A
Repetitive Peak Forward Current ( $T_J = 175^\circ\text{C}$ , $t_p$ limited by $T_{Jmax}$ )	I <sub>FRM</sub>	225	A
Maximum Power Dissipation @ $T_C = 80^\circ\text{C}$ ( $T_J = 175^\circ\text{C}$ )	P <sub>tot</sub>	216	W
Minimum Operating Junction Temperature	T <sub>JMIN</sub>	–40	°C
Maximum Operating Junction Temperature	T <sub>JMAX</sub>	175	°C

# NXH200T120H3Q2F2STNG

**Table 1. ABSOLUTE MAXIMUM RATINGS** (Note 1) ( $T_J = 25^\circ\text{C}$  unless otherwise noted) (continued)

Rating	Symbol	Value	Unit
<b>NEUTRAL POINT INVERSE DIODE</b>			
Peak Repetitive Reverse Voltage	$V_{RRM}$	650	V
Continuous Forward Current @ $T_C = 80^\circ\text{C}$ ( $T_J = 175^\circ\text{C}$ )	$I_F$	36	A
Repetitive Peak Forward Current ( $T_J = 175^\circ\text{C}$ , $t_p$ limited by $T_{Jmax}$ )	$I_{FRM}$	108	A
Maximum Power Dissipation @ $T_C = 80^\circ\text{C}$ ( $T_J = 175^\circ\text{C}$ )	$P_{tot}$	90	W
Minimum Operating Junction Temperature	$T_{JMIN}$	-40	$^\circ\text{C}$
Maximum Operating Junction Temperature	$T_{JMAX}$	175	$^\circ\text{C}$

**THERMAL PROPERTIES**

Storage Temperature range	$T_{stg}$	-40 to 125	$^\circ\text{C}$
---------------------------	-----------	------------	------------------

**INSULATION PROPERTIES**

Isolation Test Voltage, $t = 2$ sec, 50 Hz	$V_{is}$	4000	$V_{RMS}$
Creepage Distance		12.7	mm

Stresses exceeding those listed in the Maximum Ratings table may damage the device. If any of these limits are exceeded, device functionality should not be assumed, damage may occur and reliability may be affected.

1. Refer to ELECTRICAL CHARACTERISTICS, RECOMMENDED OPERATING RANGES and/or APPLICATION INFORMATION for Safe Operating parameters.

**Table 2. RECOMMENDED OPERATING RANGES**

Rating	Symbol	Min	Max	Unit
Module Operating Junction Temperature	$T_J$	-40	( $T_{Jmax} - 25$ )	$^\circ\text{C}$

Functional operation above the stresses listed in the Recommended Operating Ranges is not implied. Extended exposure to stresses beyond the Recommended Operating Ranges limits may affect device reliability.

**Table 3. ELECTRICAL CHARACTERISTICS** ( $T_J = 25^\circ\text{C}$  unless otherwise noted)

Parameter	Test Conditions	Symbol	Min	Typ	Max	Unit
<b>HALF BRIDGE IGBT CHARACTERISTICS</b>						
Collector-Emitter Cutoff Current	$V_{GE} = 0\text{ V}$ , $V_{CE} = 1200\text{ V}$	$I_{CES}$	-	-	500	$\mu\text{A}$
Collector-Emitter Saturation Voltage	$V_{GE} = 15\text{ V}$ , $I_C = 200\text{ A}$ , $T_J = 25^\circ\text{C}$	$V_{CE(sat)}$	1.40	1.86	2.30	V
	$V_{GE} = 15\text{ V}$ , $I_C = 200\text{ A}$ , $T_J = 175^\circ\text{C}$		-	2.00	-	
Gate-Emitter Threshold Voltage	$V_{GE} = V_{CE}$ , $I_C = 6\text{ mA}$	$V_{GE(TH)}$	4.80	5.52	6.50	V
Gate Leakage Current	$V_{GE} = 20\text{ V}$ , $V_{CE} = 0\text{ V}$	$I_{GES}$	-	-	500	nA
Breakdown Voltage	$V_{GE} = 0\text{ V}$ , $I_C = 1\text{ mA}$	$B_{V_{CES}}$	1200	1400	1450	V
Turn-on Delay Time	$T_J = 25^\circ\text{C}$ $V_{CE} = 350\text{ V}$ , $I_C = 170\text{ A}$ , $V_{GE} = -5/+15\text{ V}$ , $R_G = 10\ \Omega$	$t_{d(on)}$	-	302	-	ns
Rise Time		$t_r$	-	102	-	
Turn-off Delay Time		$t_{d(off)}$	-	923	-	
Fall Time		$t_f$	-	59	-	
Turn-on Switching Loss per Pulse		$E_{on}$	-	5.1	-	mJ
Turn-off Switching Loss per Pulse		$E_{off}$	-	5.4	-	

# NXH200T120H3Q2F2STNG

**Table 3. ELECTRICAL CHARACTERISTICS** ( $T_J = 25^\circ\text{C}$  unless otherwise noted) (continued)

Parameter	Test Conditions	Symbol	Min	Typ	Max	Unit
<b>HALF BRIDGE IGBT CHARACTERISTICS</b>						
Turn-on Delay Time	$T_J = 125^\circ\text{C}$ $V_{CE} = 350\text{ V}, I_C = 170\text{ A}, V_{GE} = -5/+15\text{ V},$ $R_G = 10\ \Omega$	$t_{d(on)}$	–	276	–	ns
Rise Time		$t_r$	–	97	–	
Turn-off Delay Time		$t_{d(off)}$	–	997	–	
Fall Time		$t_f$	–	99	–	
Turn-on Switching Loss per Pulse		$E_{on}$	–	5.4	–	mJ
Turn-off Switching Loss per Pulse		$E_{off}$	–	7.9	–	
Input Capacitance	$V_{CE} = 25\text{ V}, V_{GE} = 0\text{ V}$ $f = 100\text{ kHz}$	$C_{ies}$	–	35615	–	pF
Output Capacitance		$C_{oes}$	–	700	–	
Reverse Transfer Capacitance		$C_{res}$	–	530	–	
Total Gate Charge	$V_{CE} = 600\text{ V}, I_C = 200\text{ A}, V_{GE} = 15\text{ V}$	$Q_g$	–	1706.4	–	nC
Thermal Resistance – chip-to-heatsink	Thermal grease, Thickness < 100 $\mu\text{m}$ , $\lambda = 2.87\text{ W/mK}$	$R_{thJH}$	–	0.21	–	$^\circ\text{C/W}$
Thermal Resistance – chip-to-case		$R_{thJC}$	–	0.14	–	$^\circ\text{C/W}$

### NEUTRAL POINT FREEWHEEL DIODE CHARACTERISTICS

Diode Reverse Leakage Current	$V_R = 650\text{ V}$	$I_R$	–	–	100	$\mu\text{A}$	
Diode Forward Voltage	$I_F = 100\text{ A}, T_J = 25^\circ\text{C}$	$V_F$	1.2	1.48	2.7	V	
	$I_F = 100\text{ A}, T_J = 175^\circ\text{C}$		–	1.90	–		
Reverse Recovery Time	$T_J = 25^\circ\text{C}$ $V_{CE} = 350\text{ V}, I_C = 170\text{ A}, V_{GE} = -5/+15\text{ V},$ $R_G = 10\ \Omega$	$t_{rr}$	–	26.6	–	ns	
Reverse Recovery Charge		$Q_{rr}$	–	308	–	nC	
Peak Reverse Recovery Current		$I_{RRM}$	–	16.8	–	A	
Peak Rate of Fall of Recovery Current		$di/dt$	–	1659	–	$\text{A}/\mu\text{s}$	
Reverse Recovery Energy		$E_{rr}$	–	34.5	–	$\mu\text{J}$	
Reverse Recovery Time		$T_J = 125^\circ\text{C}$ $V_{CE} = 350\text{ V}, I_C = 170\text{ A}$ $V_{GE} = -5/+15\text{ V}, R_G = 10\ \Omega$	$t_{rr}$	–	25.8	–	ns
Reverse Recovery Charge			$Q_{rr}$	–	294	–	nC
Peak Reverse Recovery Current	$I_{RRM}$		–	18.0	–	A	
Peak Rate of Fall of Recovery Current	$di/dt$		–	1672	–	$\text{A}/\mu\text{s}$	
Reverse Recovery Energy	$E_{rr}$		–	35.2	–	$\mu\text{J}$	
Thermal Resistance – chip-to-heatsink	Thermal grease, Thickness < 100 $\mu\text{m}$ , $\lambda = 2.87\text{ W/mK}$	$R_{thJH}$	–	0.66	–	$^\circ\text{C/W}$	
Thermal Resistance – chip-to-case		$R_{thJC}$	–	0.55	–	$^\circ\text{C/W}$	

### NEUTRAL POINT IGBT CHARACTERISTICS

Collector-Emitter Cutoff Current	$V_{GE} = 0\text{ V}, V_{CE} = 650\text{ V}$	$I_{CES}$	–	–	300	$\mu\text{A}$
Collector-Emitter Saturation Voltage	$V_{GE} = 15\text{ V}, I_C = 150\text{ A}, T_J = 25^\circ\text{C}$	$V_{CE(sat)}$	0.8	1.36	2.05	V
	$V_{GE} = 15\text{ V}, I_C = 150\text{ A}, T_J = 175^\circ\text{C}$		–	1.50	–	
Gate-Emitter Threshold Voltage	$V_{GE} = V_{CE}, I_C = 1.2\text{ mA}$	$V_{GE(TH)}$	3.5	4.03	6.4	V
Gate Leakage Current	$V_{GE} = 20\text{ V}, V_{CE} = 0\text{ V}$	$I_{GES}$	–	–	300	nA
Breakdown Voltage	$V_{GE} = 0\text{ V}, I_C = 1\text{ mA}$	$B_{V_{CES}}$	650	–	–	V

# NXH200T120H3Q2F2STNG

**Table 3. ELECTRICAL CHARACTERISTICS** ( $T_J = 25^\circ\text{C}$  unless otherwise noted) (continued)

Parameter	Test Conditions	Symbol	Min	Typ	Max	Unit
<b>NEUTRAL POINT IGBT CHARACTERISTICS</b>						
Turn-on Delay Time	$T_J = 25^\circ\text{C}$ $V_{CE} = 350\text{ V}$ , $I_C = 170\text{ A}$ , $V_{GE} = -5/+15\text{ V}$ , $R_G = 10\ \Omega$	$t_{d(on)}$	–	94	–	ns
Rise Time		$t_r$	–	45	–	
Turn-off Delay Time		$t_{d(off)}$	–	224	–	
Fall Time		$t_f$	–	22	–	
Turn-on Switching Loss per Pulse		$E_{on}$	–	3.1	–	mJ
Turn off Switching Loss per Pulse		$E_{off}$	–	2.4	–	
Turn-on Delay Time	$T_J = 125^\circ\text{C}$ $V_{CE} = 350\text{ V}$ , $I_C = 170\text{ A}$ , $V_{GE} = -5/+15\text{ V}$ , $R_G = 10\ \Omega$	$t_{d(on)}$	–	92	–	ns
Rise Time		$t_r$	–	51	–	
Turn-off Delay Time		$t_{d(off)}$	–	244	–	
Fall Time		$t_f$	–	19	–	
Turn-on Switching Loss per Pulse		$E_{on}$	–	4.7	–	mJ
Turn off Switching Loss per Pulse		$E_{off}$	–	3.0	–	
Input Capacitance	$V_{CE} = 25\text{ V}$ , $V_{GE} = 0\text{ V}$ , $f = 100\text{ kHz}$	$C_{ies}$	–	9316	–	pF
Output Capacitance		$C_{oes}$	–	249	–	
Reverse Transfer Capacitance		$C_{res}$	–	34	–	
Total Gate Charge	$V_{CE} = 480\text{ V}$ , $I_C = 80\text{ A}$ , $V_{GE} = 15\text{ V}$	$Q_g$	–	300.9	–	nC
Thermal Resistance – chip-to-heatsink	Thermal grease, Thickness < 100 $\mu\text{m}$ , $\lambda = 2.87\text{ W/mK}$	$R_{thJH}$	–	0.50	–	$^\circ\text{C/W}$
Thermal Resistance – chip-to-case		$R_{thJC}$	–	0.37	–	$^\circ\text{C/W}$
<b>HALF BRIDGE FREEWHEEL DIODE CHARACTERISTICS</b>						
Diode Reverse Leakage Current	$V_R = 1200\text{ V}$	$I_R$	–	–	100	$\mu\text{A}$
Diode Forward Voltage	$I_F = 150\text{ A}$ , $T_J = 25^\circ\text{C}$	$V_F$	1.6	2.71	3.6	V
	$I_F = 150\text{ A}$ , $T_J = 175^\circ\text{C}$		–	2.00	–	
Reverse Recovery Time	$T_J = 25^\circ\text{C}$ $V_{CE} = 350\text{ V}$ , $I_C = 170\text{ A}$ , $V_{GE} = -5/+15\text{ V}$ , $R_G = 10\ \Omega$	$t_{rr}$	–	62	–	ns
Reverse Recovery Charge		$Q_{rr}$	–	4700	–	nC
Peak Reverse Recovery Current		$I_{RRM}$	–	144	–	A
Peak Rate of Fall of Recovery Current		$di/dt$	–	4017	–	$\text{A}/\mu\text{s}$
Reverse Recovery Energy		$E_{rr}$	–	849	–	$\mu\text{J}$
Reverse Recovery Time		$T_J = 125^\circ\text{C}$ $V_{CE} = 350\text{ V}$ , $I_C = 170\text{ A}$ , $V_{GE} = -5/+15\text{ V}$ , $R_G = 10\ \Omega$	$t_{rr}$	–	107	–
Reverse Recovery Charge	$Q_{rr}$		–	12510	–	nC
Peak Reverse Recovery Current	$I_{RRM}$		–	216	–	A
Peak Rate of Fall of Recovery Current	$di/dt$		–	3815	–	$\text{A}/\mu\text{s}$
Reverse Recovery Energy	$E_{rr}$		–	2647	–	$\mu\text{J}$
Thermal Resistance – chip-to-heatsink	Thermal grease, Thickness < 100 $\mu\text{m}$ , $\lambda = 2.87\text{ W/mK}$		$R_{thJH}$	–	0.49	–
Thermal Resistance – chip-to-case		$R_{thJC}$	–	0.38	–	$^\circ\text{C/W}$

# NXH200T120H3Q2F2STNG

**Table 3. ELECTRICAL CHARACTERISTICS** ( $T_J = 25^\circ\text{C}$  unless otherwise noted) (continued)

Parameter	Test Conditions	Symbol	Min	Typ	Max	Unit
<b>HALF BRIDGE INVERSE DIODE CHARACTERISTICS</b>						
Diode Forward Voltage	$I_F = 7\text{ A}, T_J = 25^\circ\text{C}$	$V_F$	1.05	1.93	2.80	V
	$I_F = 7\text{ A}, T_J = 175^\circ\text{C}$		–	1.29	–	
Thermal Resistance – chip-to-heatsink	Thermal grease, Thickness < 100 $\mu\text{m}$ , $\lambda = 2.87\text{ W/mK}$	$R_{thJH}$	–	1.35	–	$^\circ\text{C/W}$
Thermal Resistance – chip-to-case		$R_{thJC}$	–	1.24	–	$^\circ\text{C/W}$
<b>NEUTRAL POINT INVERSE DIODE CHARACTERISTICS</b>						
Diode Forward Voltage	$I_F = 30\text{ A}, T_J = 25^\circ\text{C}$	$V_F$	1.3	2.35	3.2	V
	$I_F = 30\text{ A}, T_J = 175^\circ\text{C}$		–	1.50	–	
Thermal Resistance – chip-to-heatsink	Thermal grease, Thickness 100 $\mu\text{m}$ , $\lambda = 2.87\text{ W/mK}$	$R_{thJH}$	–	1.03	–	$^\circ\text{C/W}$
Thermal Resistance – chip-to-case		$R_{thJC}$	–	0.91	–	$^\circ\text{C/W}$
<b>THERMISTOR CHARACTERISTICS</b>						
Nominal resistance		$R_{25}$	–	22	–	k $\Omega$
Nominal resistance	$T = 100^\circ\text{C}$	$R_{100}$	–	1486	–	$\Omega$
Deviation of $R_{25}$		R/R	–5	–	5	%
Power dissipation		$P_D$	–	200	–	mW
Power dissipation constant			–	2	–	mW/K
B-value	$B(25/50)$ , tolerance $\pm 3\%$		–	3950	–	K
B-value	$B(25/100)$ , tolerance $\pm 3\%$		–	3998	–	K

Product parametric performance is indicated in the Electrical Characteristics for the listed test conditions, unless otherwise noted. Product performance may not be indicated by the Electrical Characteristics if operated under different conditions.

## ORDERING INFORMATION

Device	Marking	Package	Shipping
NXH200T120H3Q2F2STNG	NXH200T120H3Q2F2STNG	Q2PACK – Case 180AK with pre-applied thermal interface material (TIM) (Pb-Free and Halide-Free)	12 Units / Blister Tray

# NXH200T120H3Q2F2STNG

## TYPICAL CHARACTERISTICS – HALF BRIDGE IGBT AND NEUTRAL POINT DIODE

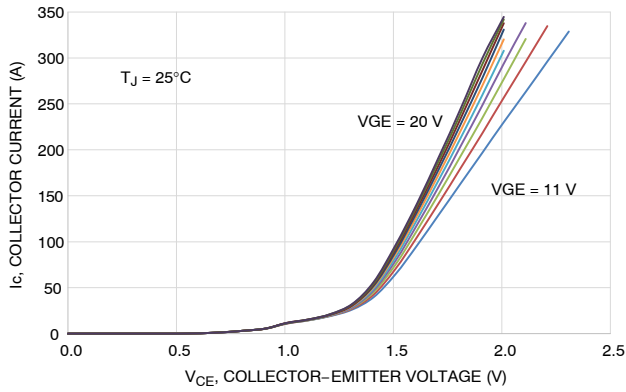

Figure 2. Typical Output Characteristics

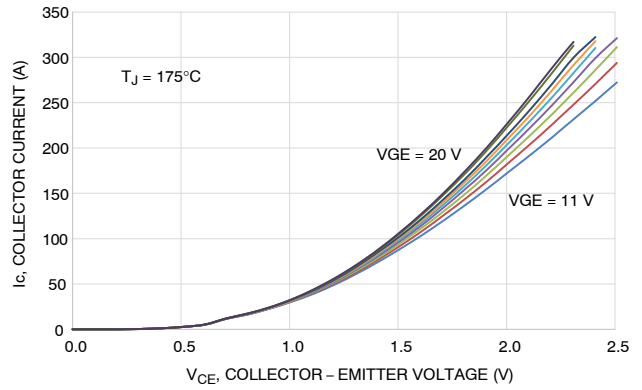

Figure 3. Typical Output Characteristics

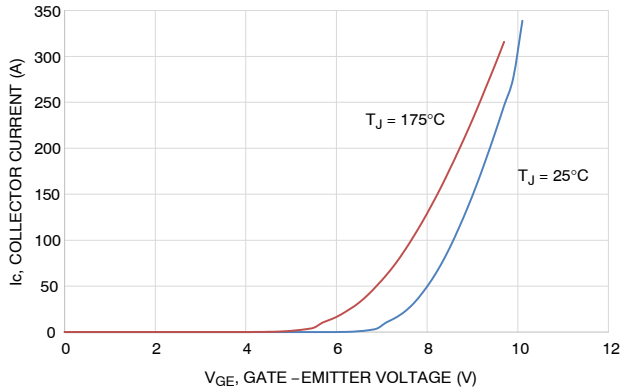

Figure 4. Typical Transfer Characteristics

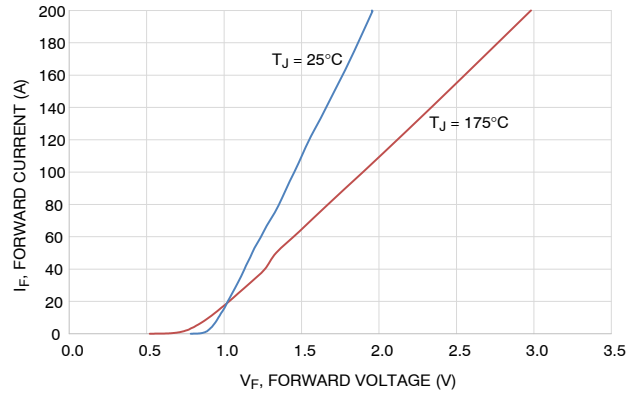

Figure 5. Typical Diode Forward Characteristics

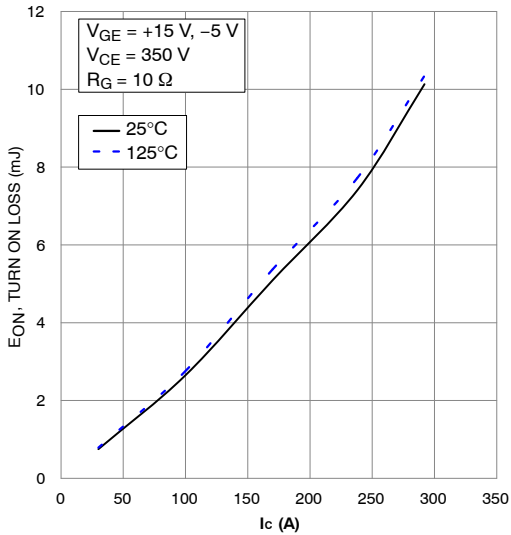

Figure 6. Typical Turn ON Loss vs.  $I_C$

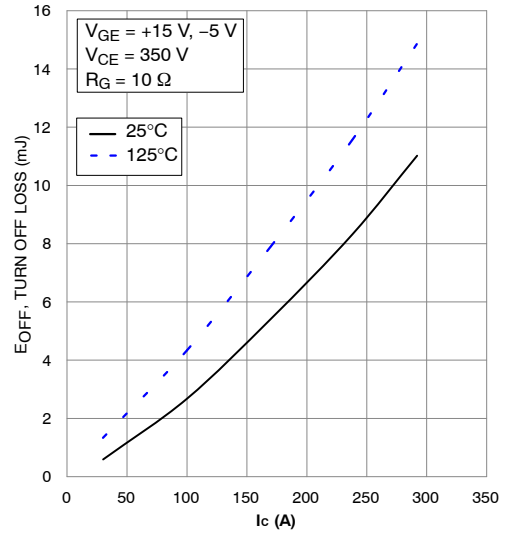

Figure 7. Typical Turn OFF Loss vs.  $I_C$

# NXH200T120H3Q2F2STNG

## TYPICAL CHARACTERISTICS – HALF BRIDGE IGBT AND NEUTRAL POINT DIODE

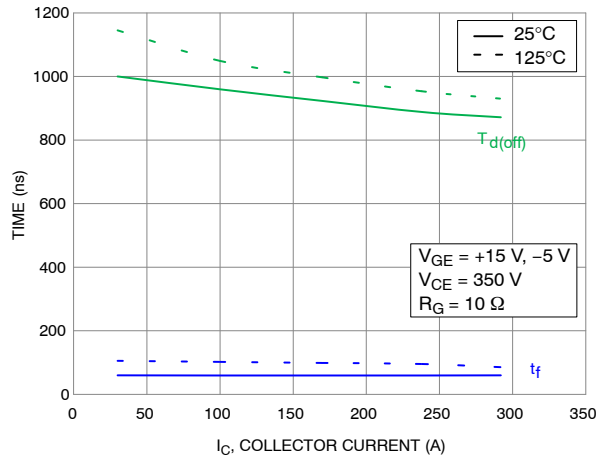

Figure 8. Typical Turn-Off Switching Time vs.  $I_C$

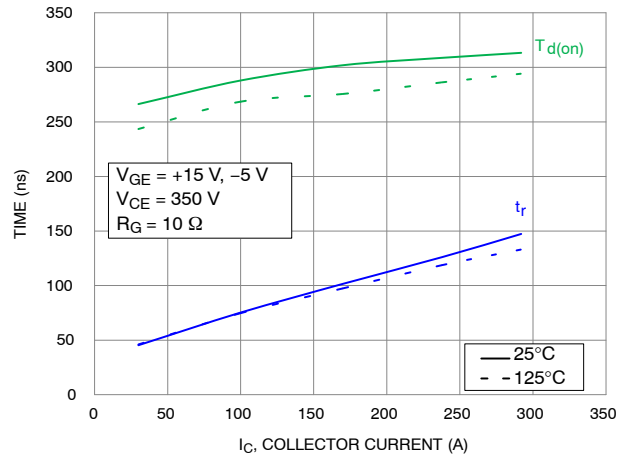

Figure 9. Typical Turn-On Switching Time vs.  $I_C$

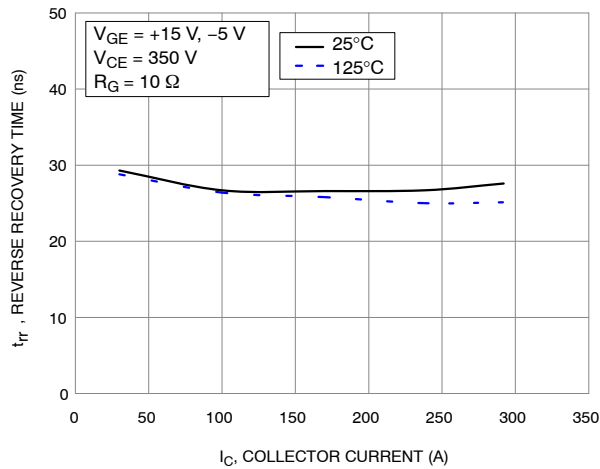

Figure 10. Typical Reverse Recovery Time vs.  $I_C$

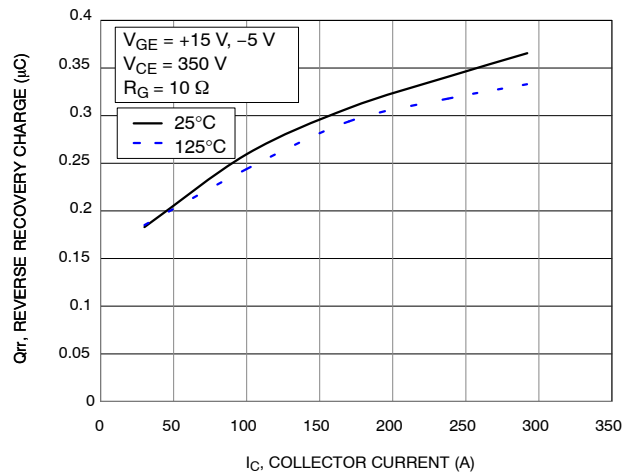

Figure 11. Typical Reverse Recovery Charge vs.  $I_C$

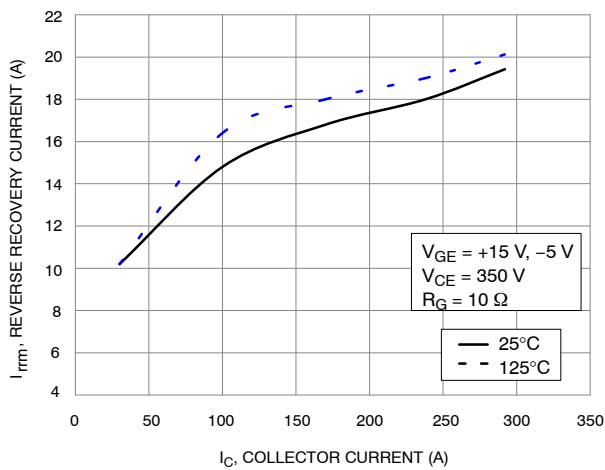

Figure 12. Typical Reverse Recovery Peak Current vs.  $I_C$

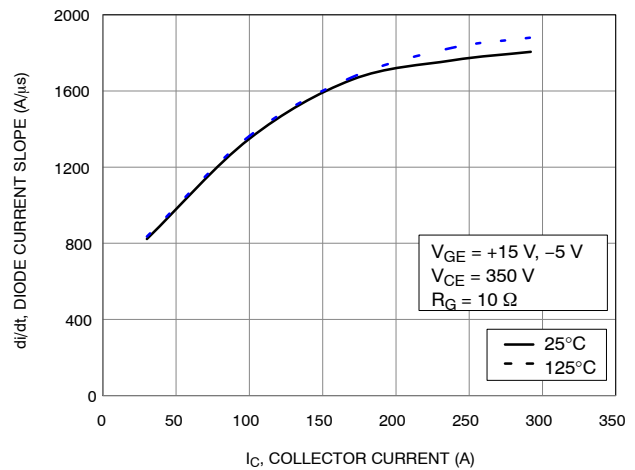

Figure 13. Typical Diode Current Slope vs.  $I_C$



# NXH200T120H3Q2F2STNG

## TYPICAL CHARACTERISTICS – HALF BRIDGE IGBT AND NEUTRAL POINT DIODE

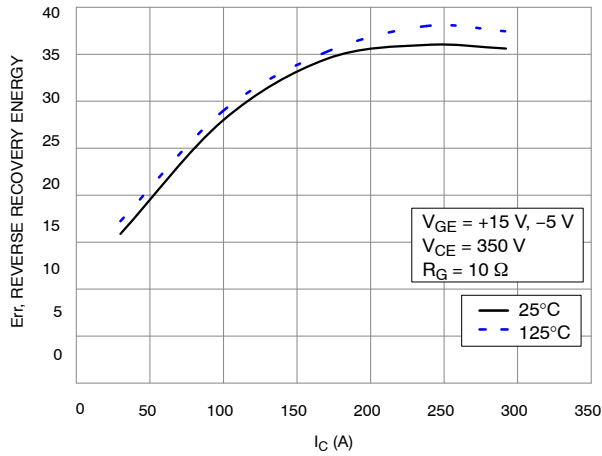

Figure 14. Typical Reverse Recovery Energy vs.  $I_C$

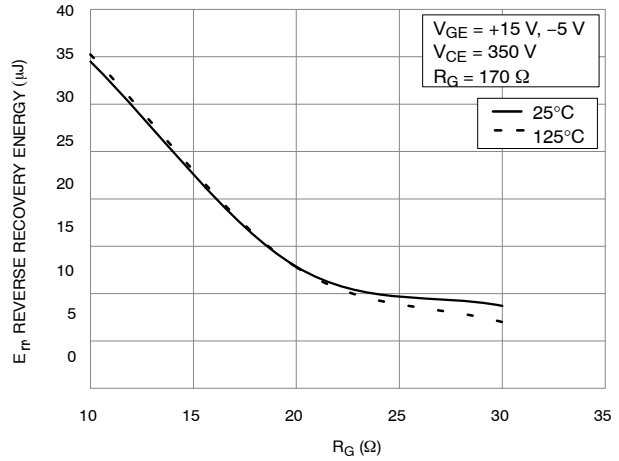

Figure 15. Typical Reverse Recovery Energy Loss vs.  $R_G$

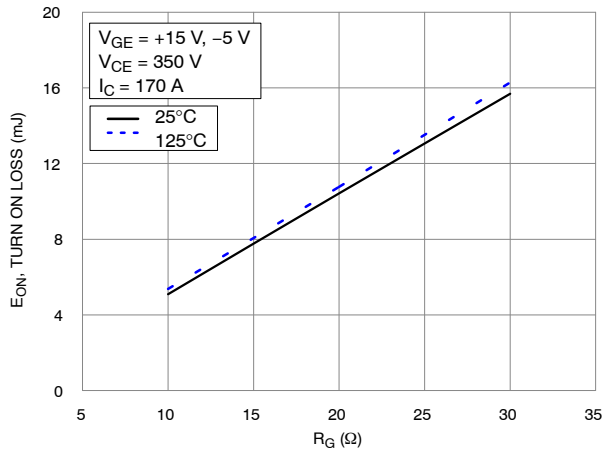

Figure 16. Typical Turn ON Loss vs.  $R_G$

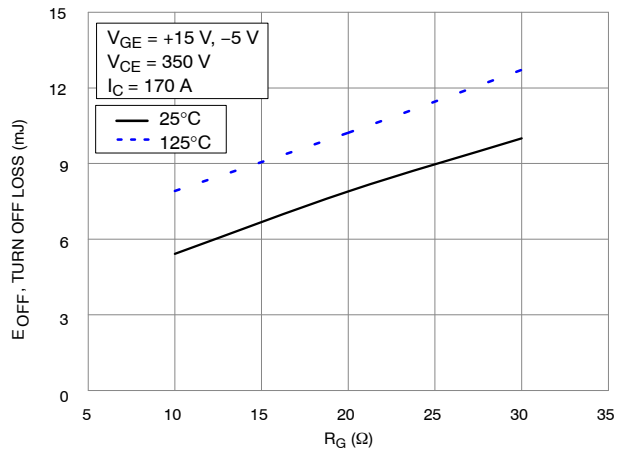

Figure 17. Typical Turn OFF vs.  $R_G$

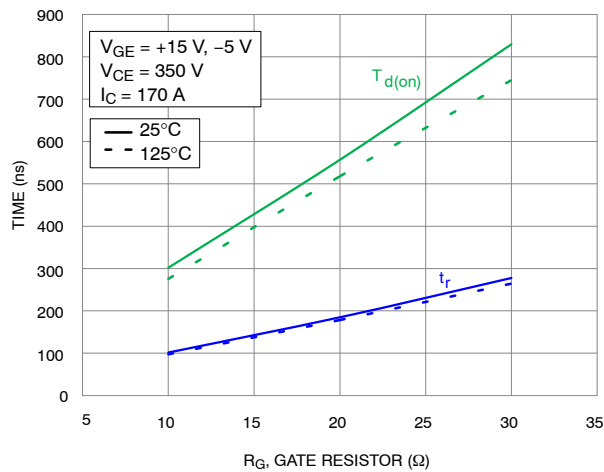

Figure 18. Typical Turn ON Switching Time vs.  $R_G$

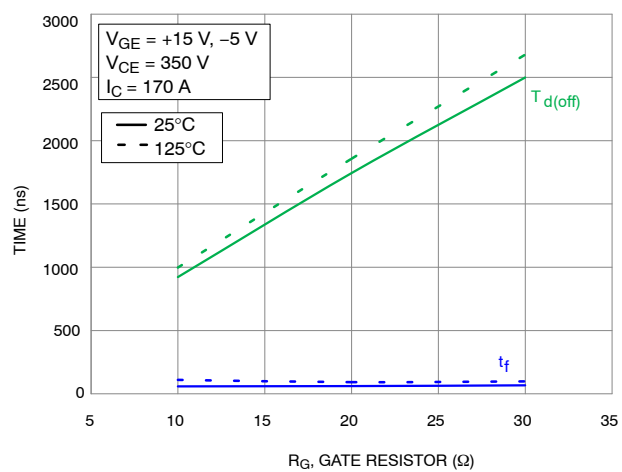

Figure 19. Typical Turn OFF Switching Time vs.  $R_G$

# NXH200T120H3Q2F2STNG

## TYPICAL CHARACTERISTICS – HALF BRIDGE IGBT AND NEUTRAL POINT DIODE

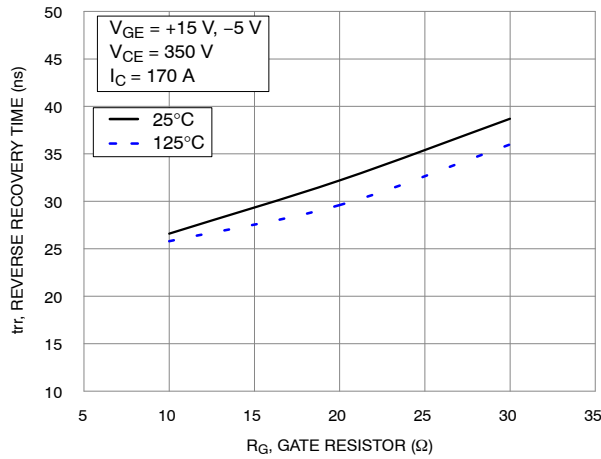

Figure 20. Typical Reverse Recovery Energy vs.  $I_C$

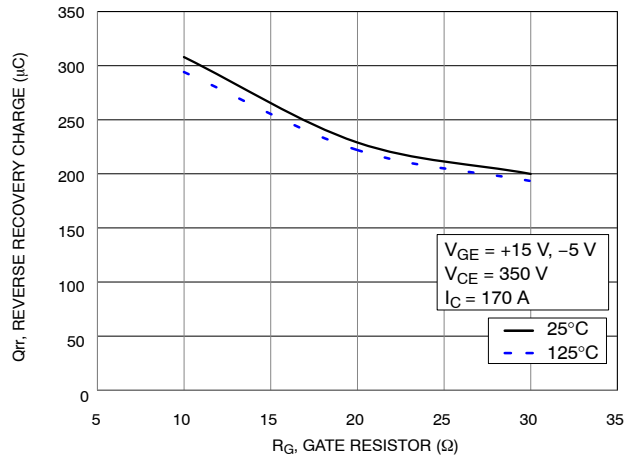

Figure 21. Typical Reverse Recovery Energy Loss vs.  $R_G$

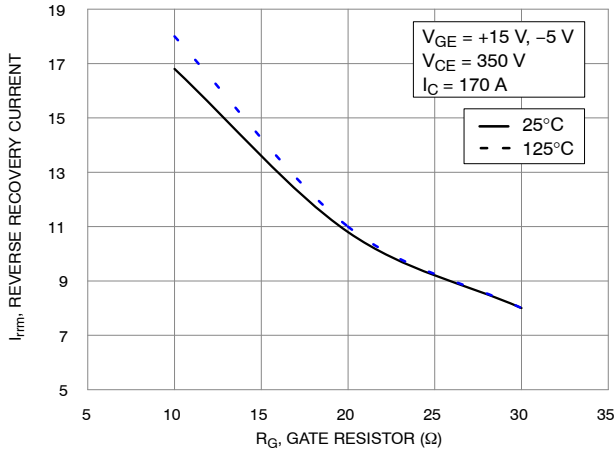

Figure 22. Typical Turn ON Loss vs.  $R_G$

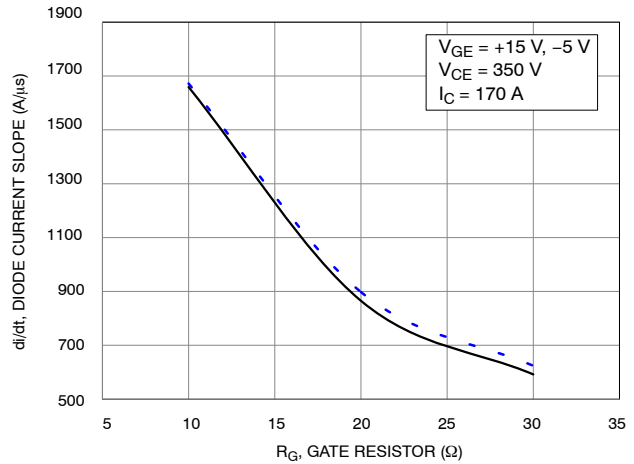

Figure 23. Typical Turn OFF vs.  $R_G$

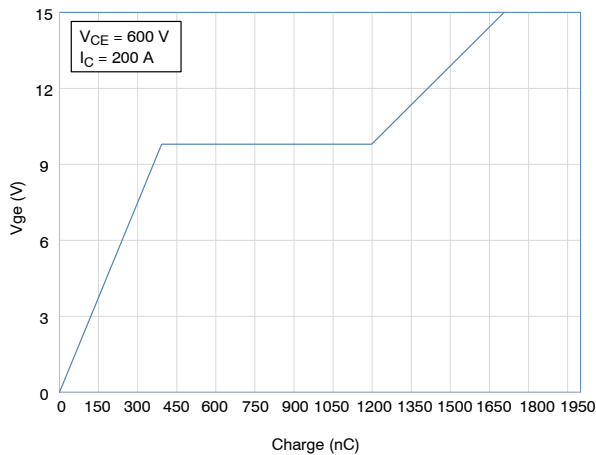

Figure 24. Gate Voltage vs. Gate Charge

# NXH200T120H3Q2F2STNG

## TYPICAL CHARACTERISTICS – HALF BRIDGE IGBT AND NEUTRAL POINT DIODE

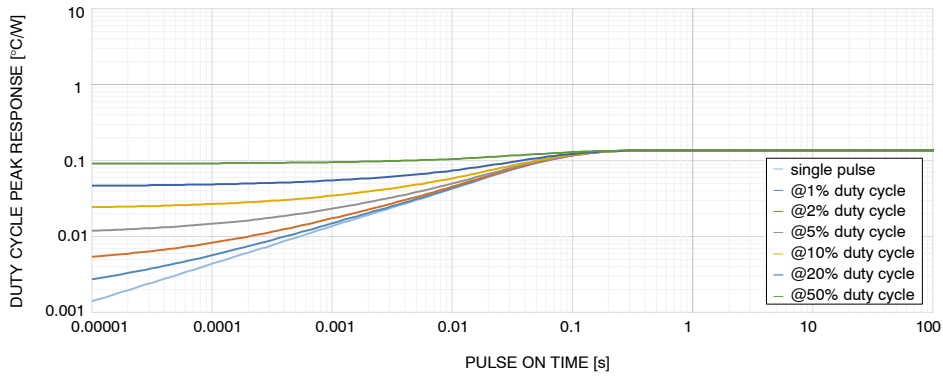

Figure 25. IGBT Transient Thermal Impedance

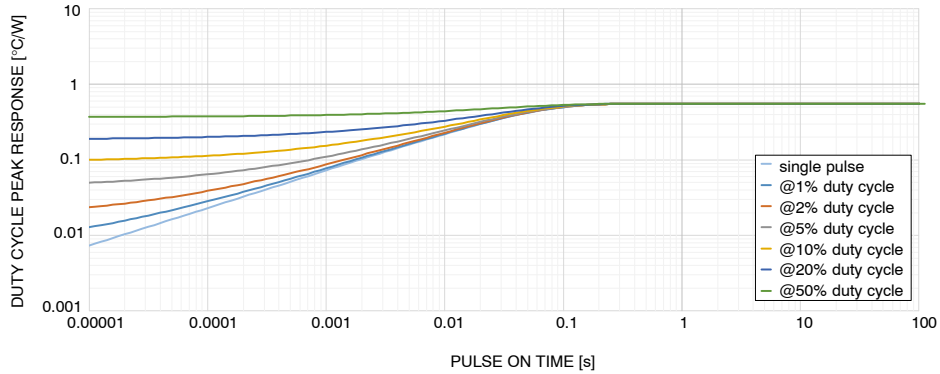

Figure 26. Diode Transient Thermal Impedance

## TYPICAL CHARACTERISTICS – HALF BRIDGE IGBT AND NEUTRAL POINT DIODE

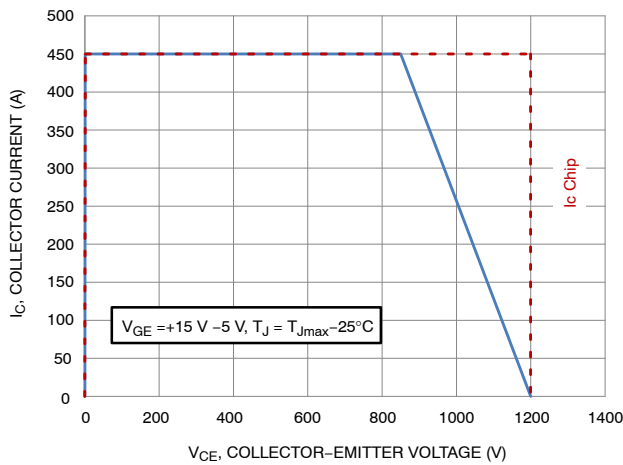

Figure 27. HB IGBT RBSOA

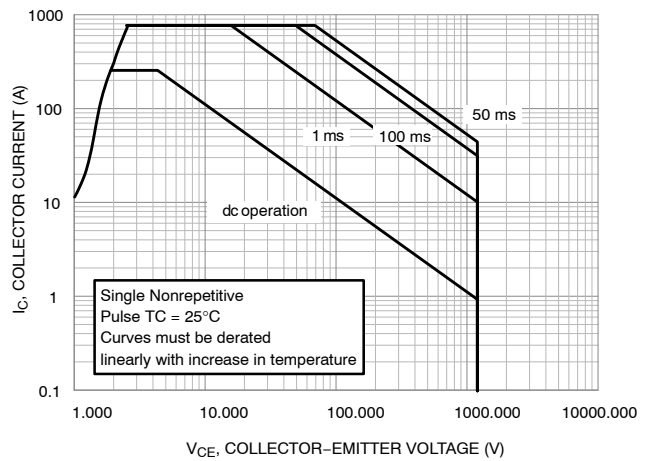

Figure 28. HB IGBT FBSOA

# NXH200T120H3Q2F2STNG

## TYPICAL CHARACTERISTICS – NEUTRAL POINT IGBT AND HALF BRIDGE DIODE

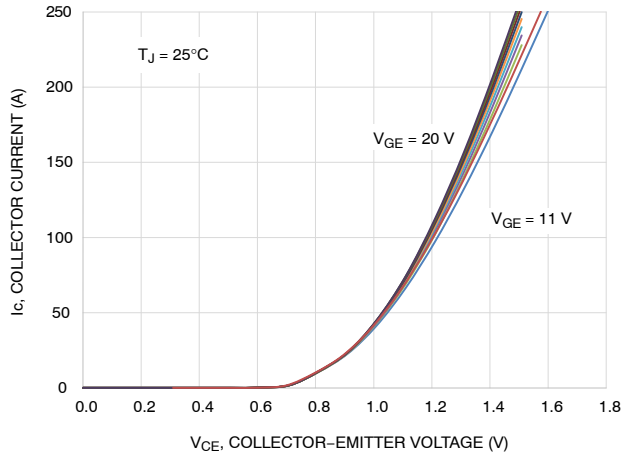

Figure 29. Typical Output Characteristics

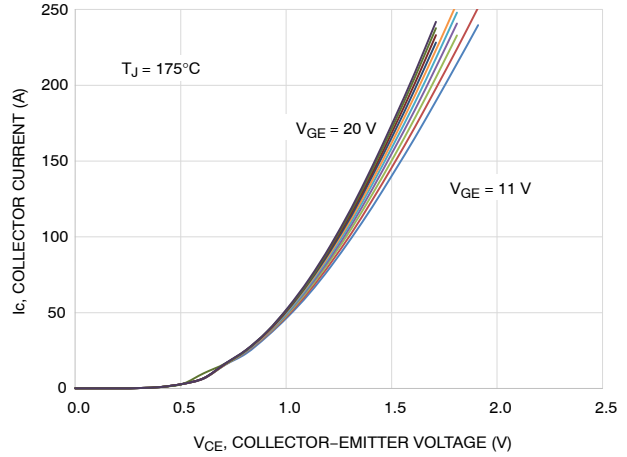

Figure 30. Typical Output Characteristics

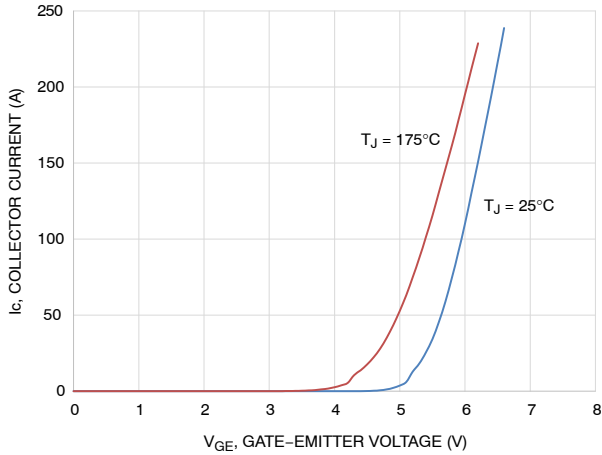

Figure 31. Typical Transfer Characteristics

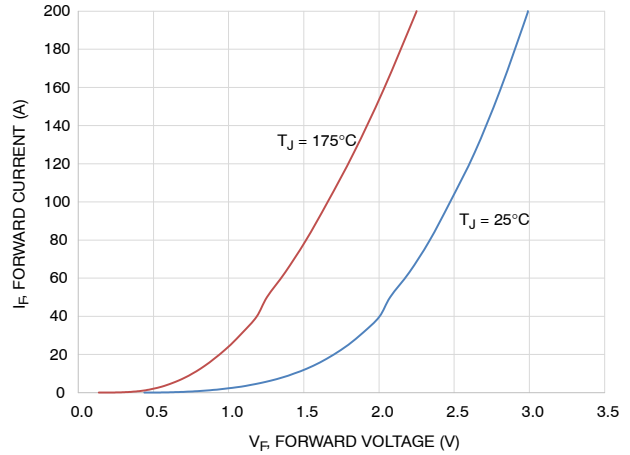
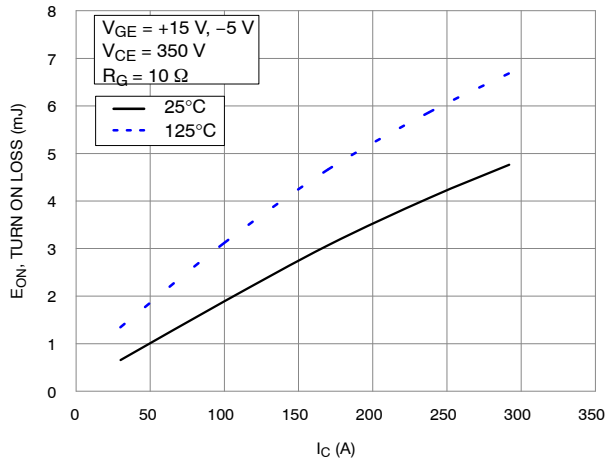

Figure 32. Typical Diode Forward Characteristics

# NXH200T120H3Q2F2STNG

## TYPICAL CHARACTERISTICS – NEUTRAL POINT IGBT AND HALF BRIDGE DIODE



**Figure 33. Typical Turn ON Loss vs.  $I_C$**

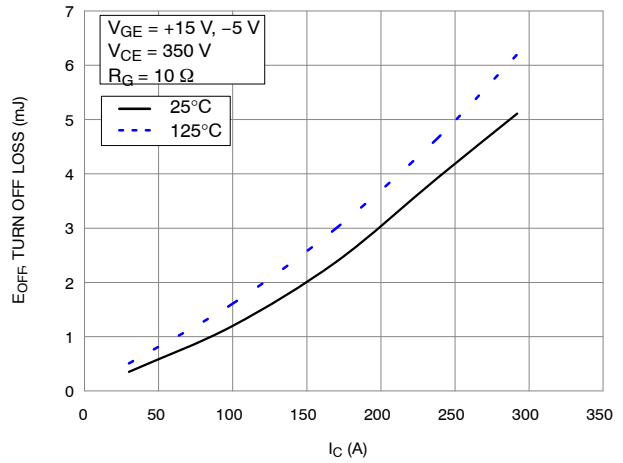

**Figure 34. Typical Turn OFF Loss vs.  $I_C$**

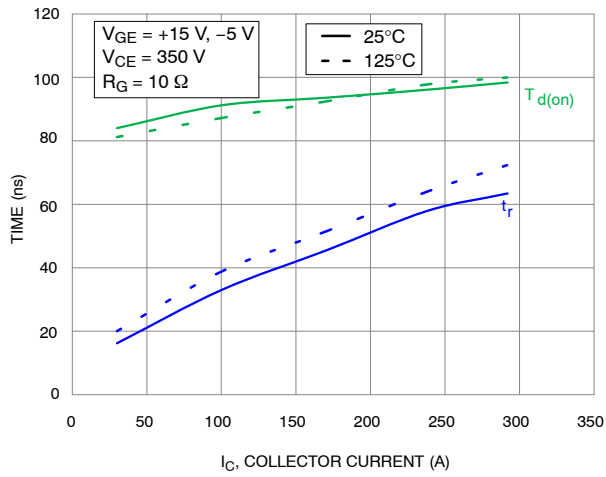

**Figure 35. Typical Turn ON Switching Time vs.  $I_C$**

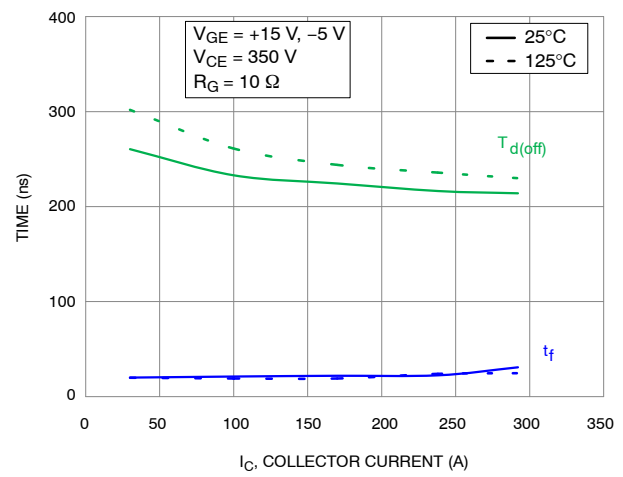

**Figure 36. Typical Turn OFF Switching Time vs.  $I_C$**

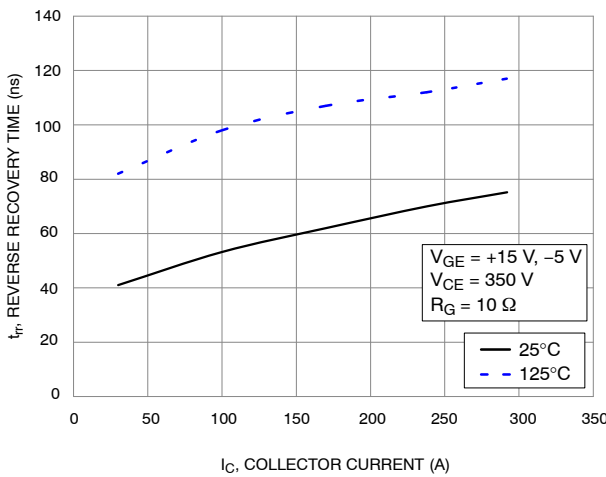

**Figure 37. Typical Reverse Recovery Time vs.  $I_C$**

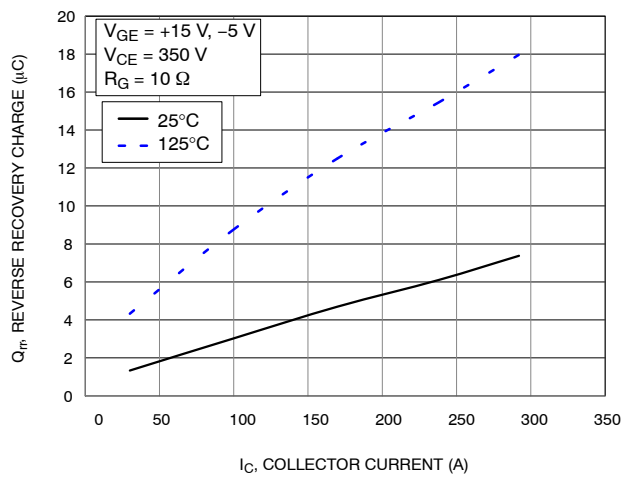

**Figure 38. Typical Reverse Recovery Charge vs.  $I_C$**

# NXH200T120H3Q2F2STNG

## TYPICAL CHARACTERISTICS – NEUTRAL POINT IGBT AND HALF BRIDGE DIODE

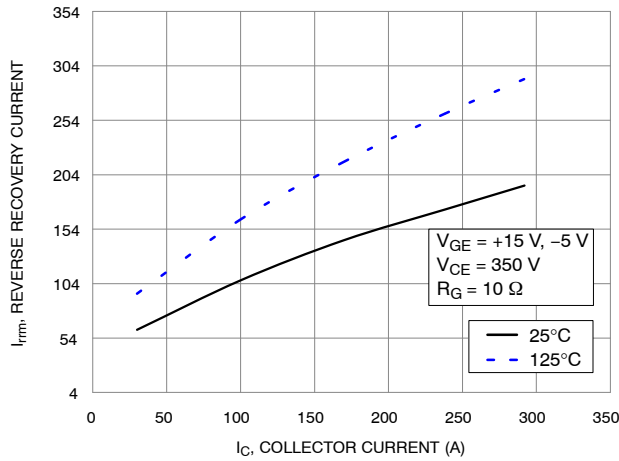

Figure 39. Typical Turn ON Loss vs.  $I_C$

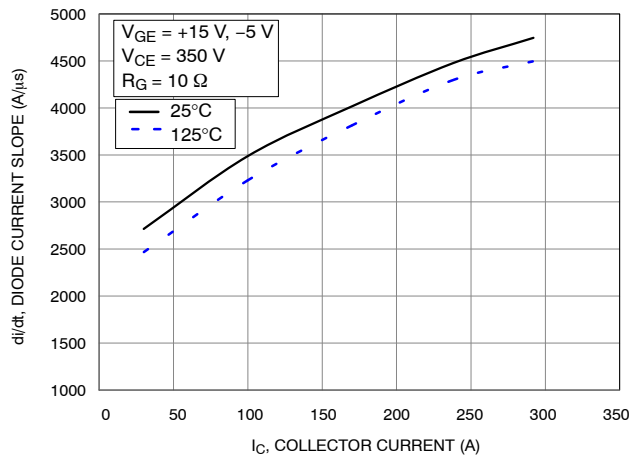

Figure 40. Typical Turn OFF Loss vs.  $I_C$

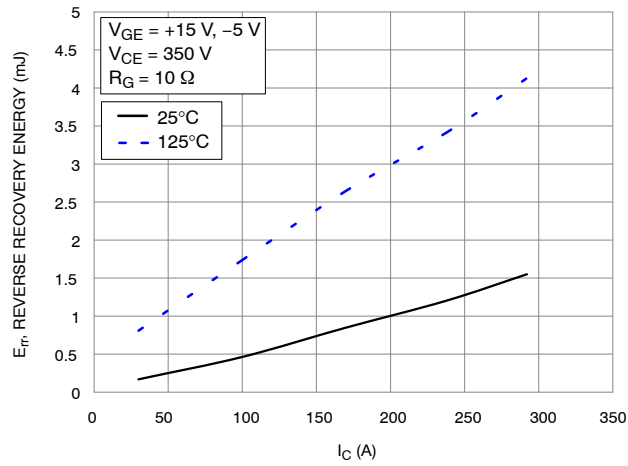

Figure 41. Typical Turn ON Switching Time vs.  $I_C$

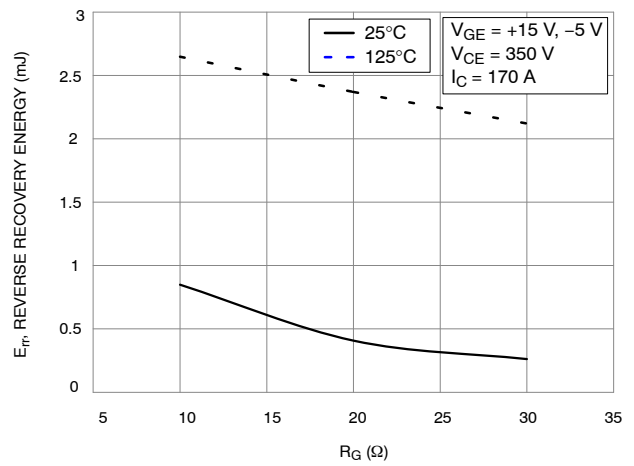

Figure 42. Typical Turn OFF Switching Time vs.  $I_C$

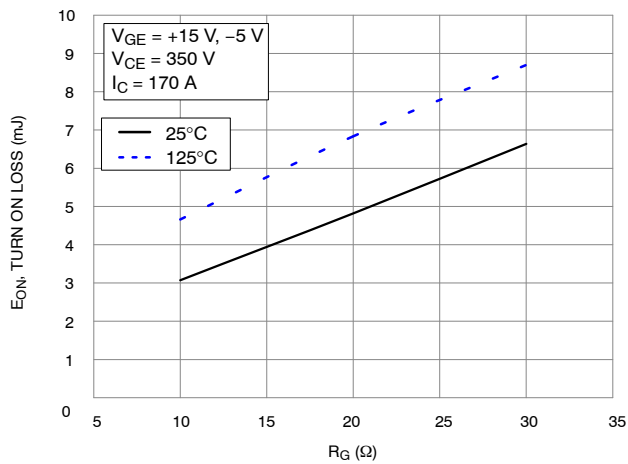

Figure 43. Typical Turn ON Loss vs.  $R_G$

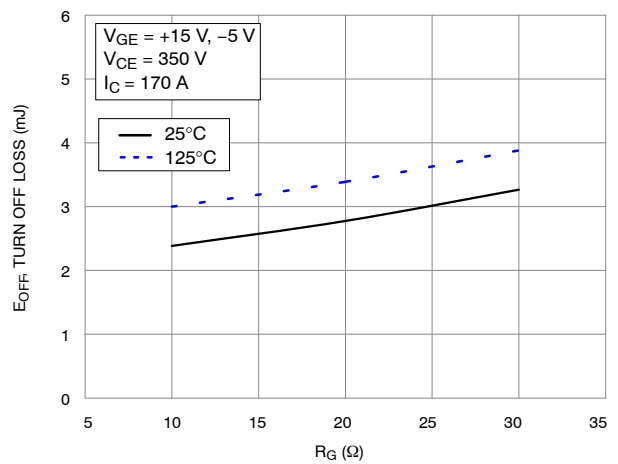

Figure 44. Typical Turn OFF vs.  $R_G$

# NXH200T120H3Q2F2STNG

## TYPICAL CHARACTERISTICS – NEUTRAL POINT IGBT AND HALF BRIDGE DIODE

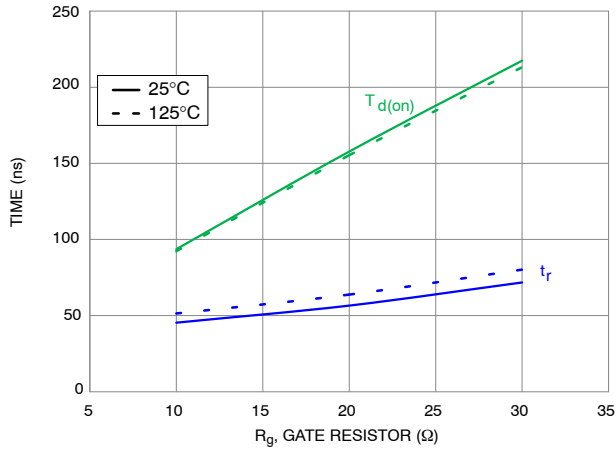

Figure 45. Typical Turn ON Switching Time vs.  $R_G$

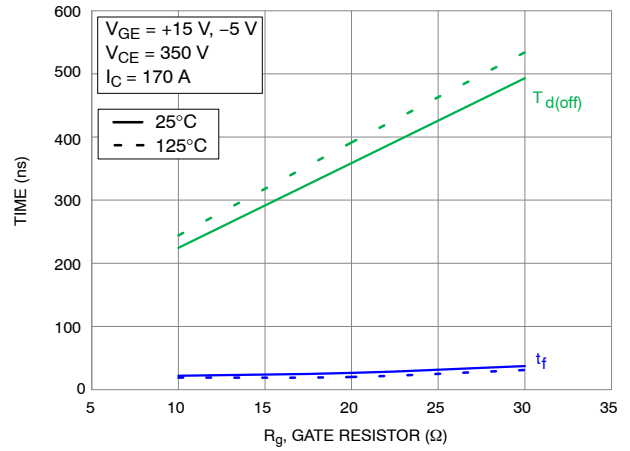

Figure 46. Typical Turn OFF Switching Time vs.  $R_G$

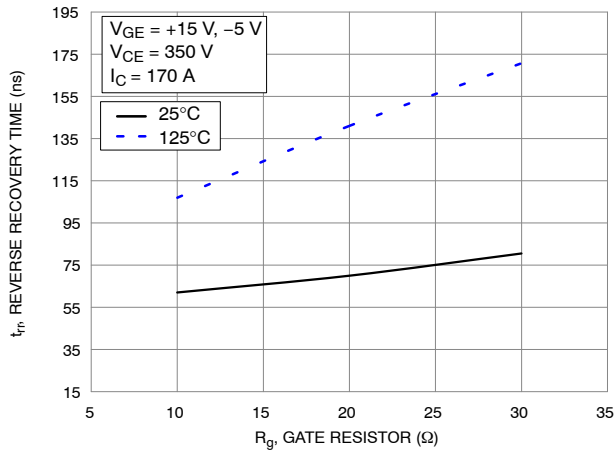

Figure 47. Typical Reverse Recovery Time vs.  $R_G$

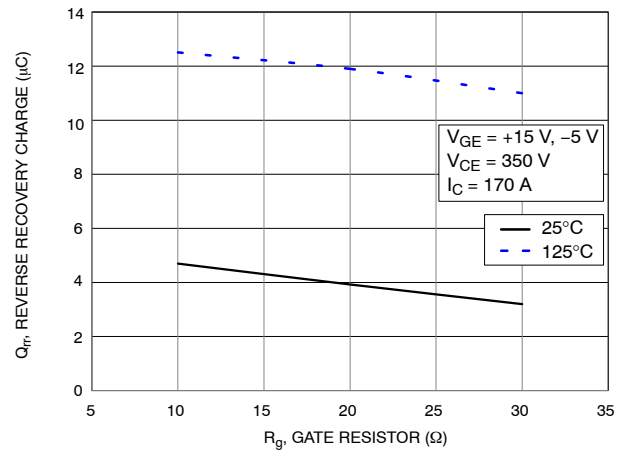

Figure 48. Typical Reverse Recovery Charge vs.  $R_G$

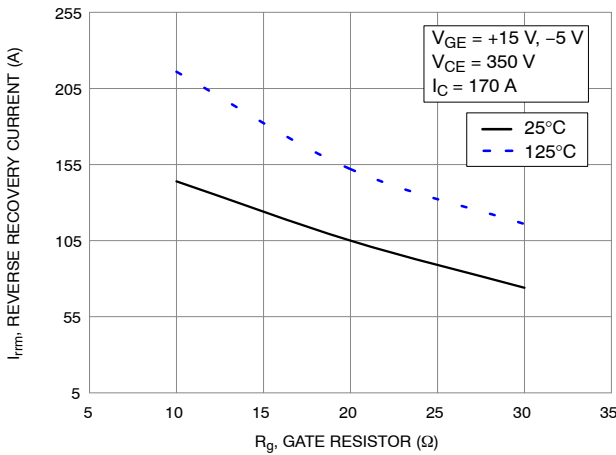

Figure 49. Typical Reverse Recovery Peak Current vs.  $R_G$

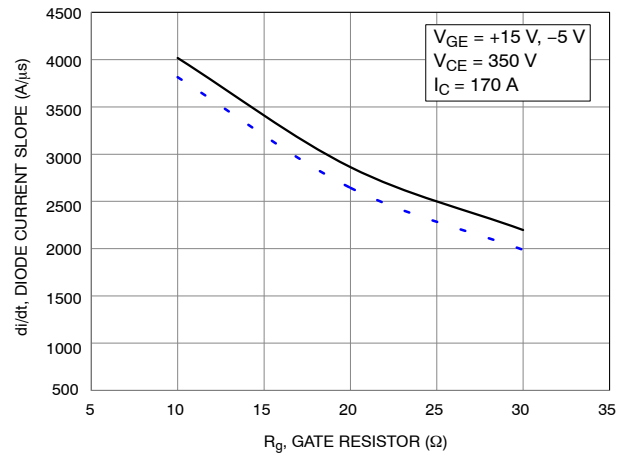

Figure 50. Typical Di/Dt vs.  $R_G$

# NXH200T120H3Q2F2STNG

## TYPICAL CHARACTERISTICS – NEUTRAL POINT IGBT AND HALF BRIDGE DIODE

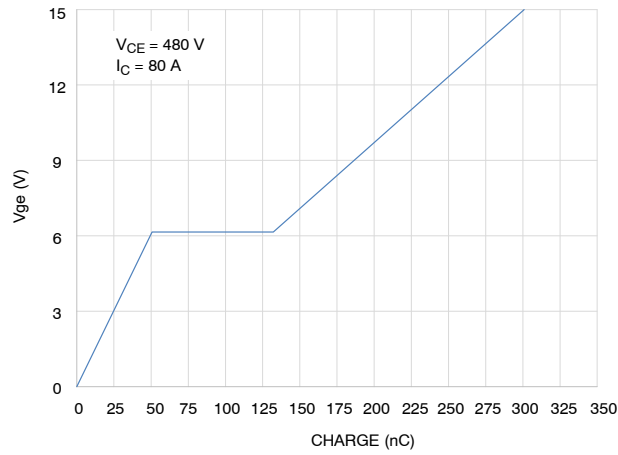

Figure 51. Gate Voltage vs. Gate Charge

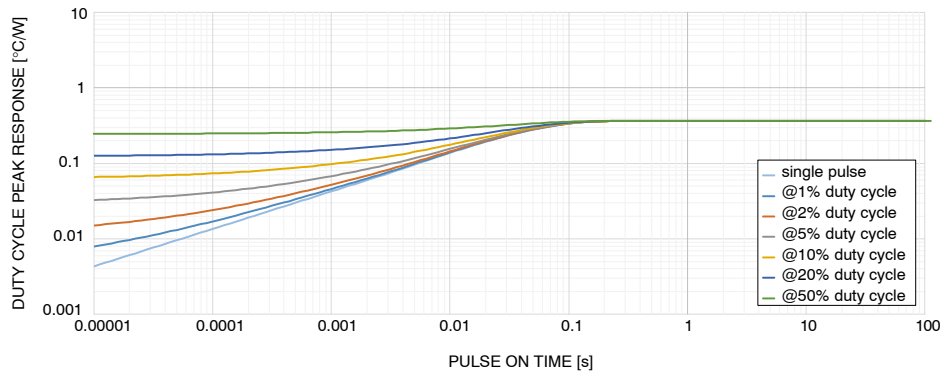

Figure 52. IGBT Transient Thermal Impedance

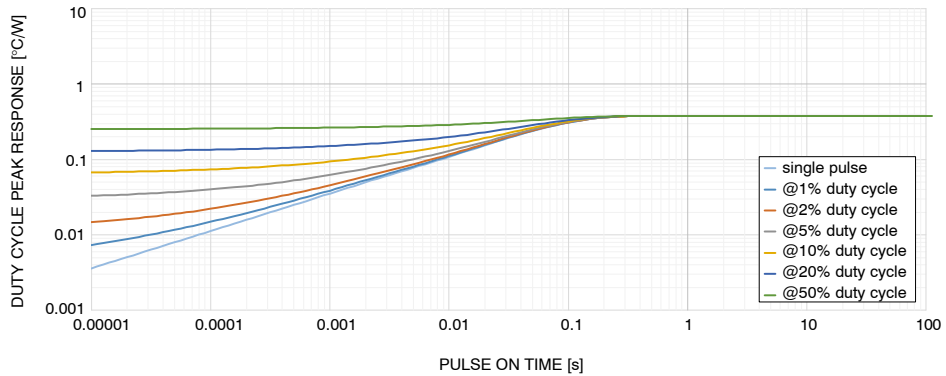

Figure 53. Diode Transient Thermal Impedance



# NXH200T120H3Q2F2STNG

## TYPICAL CHARACTERISTICS – NEUTRAL POINT IGBT AND HALF BRIDGE DIODE

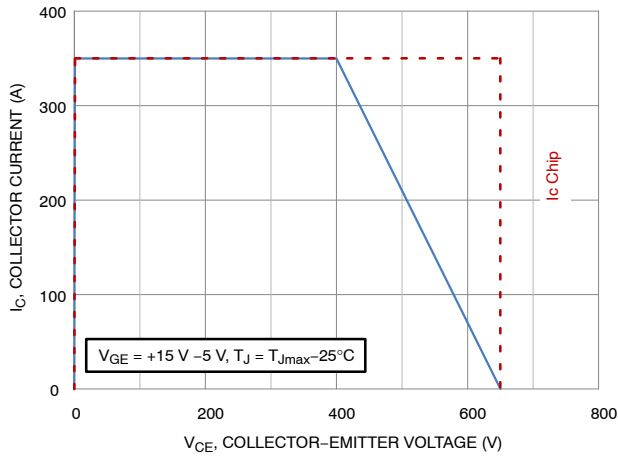

Figure 54. NP IGBT RBSOA

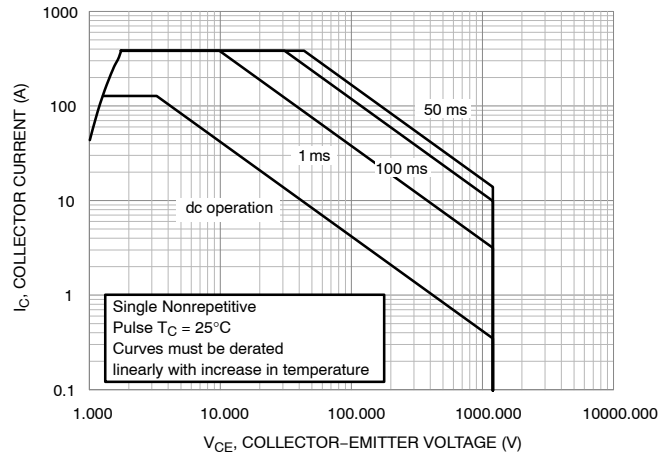

Figure 55. NP IGBT FBSOA

## TYPICAL CHARACTERISTICS – HALF BRIDGE INVERSE DIODE

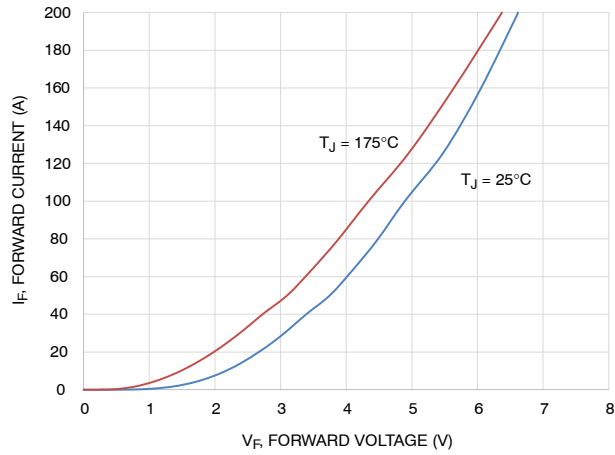

Figure 56. Diode Forward Characteristic

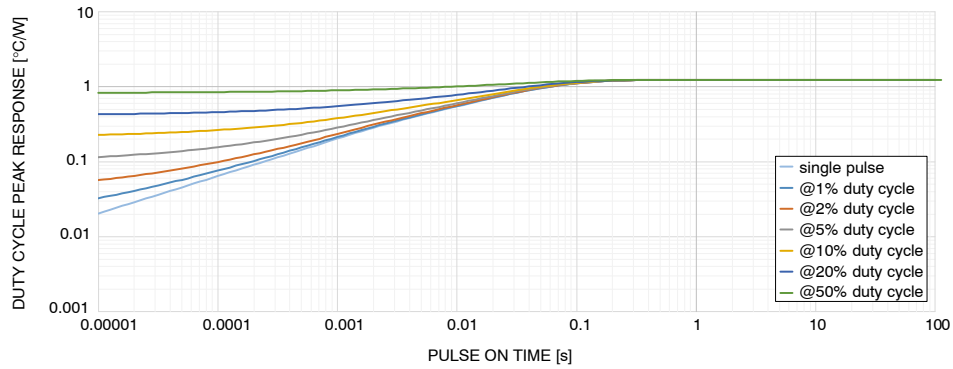

Figure 57. Diode Transient Thermal Impedance

# NXH200T120H3Q2F2STNG

## TYPICAL CHARACTERISTICS – NEUTRAL POINT INVERSE DIODE

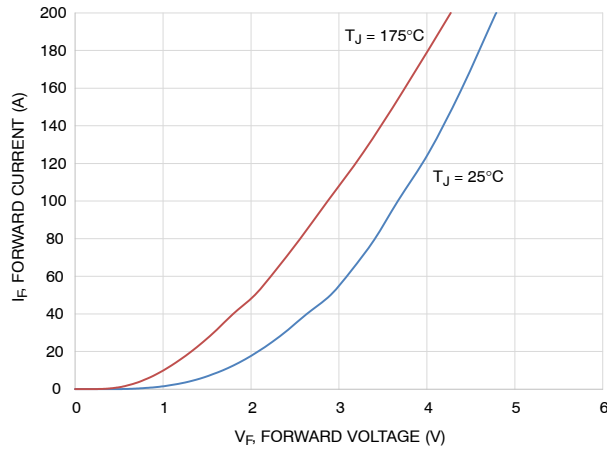

Figure 58. Diode Forward Characteristic

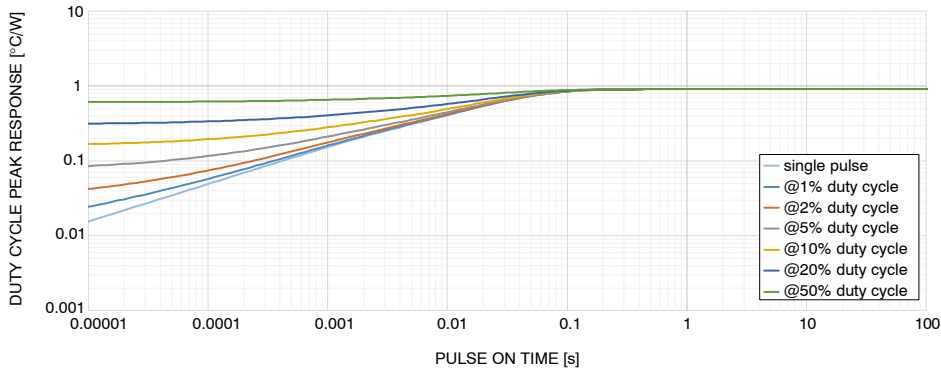

Figure 59. Diode Transient Thermal Impedance

## TYPICAL CHARACTERISTICS – THERMISTOR

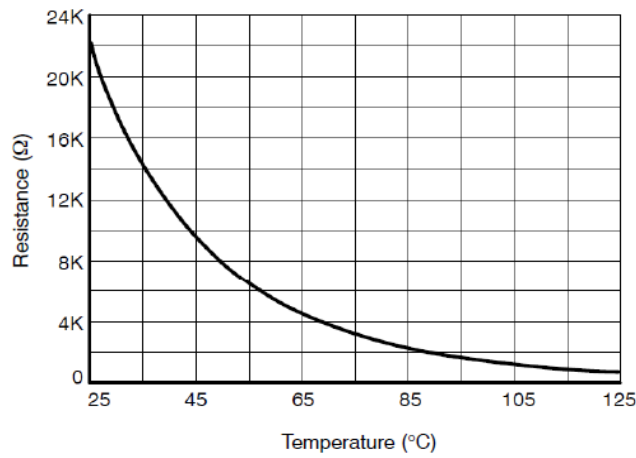

Figure 60. Thermistor Characteristics

# MECHANICAL CASE OUTLINE PACKAGE DIMENSIONS

ON Semiconductor®



## PIM56, 93x47 (SOLDER PIN) CASE 180AK ISSUE B

DATE 08 NOV 2017

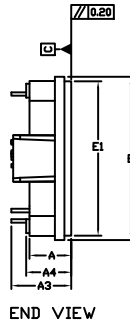
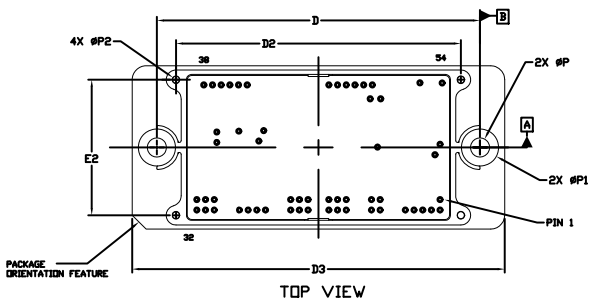
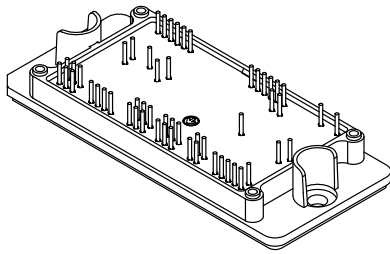

NOTES:

- DIMENSIONING AND TOLERANCING PER ASME Y14.5M, 2009.
- CONTROLLING DIMENSION= MILLIMETERS
- DIMENSIONS b APPLIES TO THE PLATED TERMINALS AND IS MEASURED BETWEEN 1.00 AND 3.00 FROM THE TERMINAL TIP.
- POSITION OF THE CENTER OF THE TERMINALS IS DETERMINED FROM DATUM B THE CENTER OF DIMENSION D, X DIRECTION, AND FROM DATUM A, Y DIRECTION. POSITIONAL TOLERANCE, AS NOTED IN DRAWING, APPLIES TO EACH TERMINAL IN BOTH DIRECTIONS.
- PACKAGE MARKING IS LOCATED AS SHOWN ON THE SIDE WITH THE PACKAGE ORIENTATION FEATURE.

		MILLIMETERS	
DIM	MIN.	MAX.	
A	11.80	12.20	
A1	4.50	4.90	
A2	16.50	16.90	
A3	16.70	17.70	
A4	12.80	13.20	
b	0.95	1.05	
D	92.80	93.20	
D1	104.60	104.90	
D2	81.80	82.20	
D3	106.90	107.50	
E	46.75	47.25	
E1	44.30	44.50	
E2	38.80	39.20	
P	5.40	5.60	
P1	10.60	10.80	
P2	2.20	2.40	

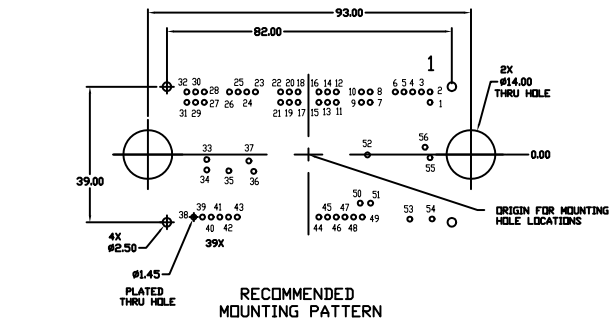
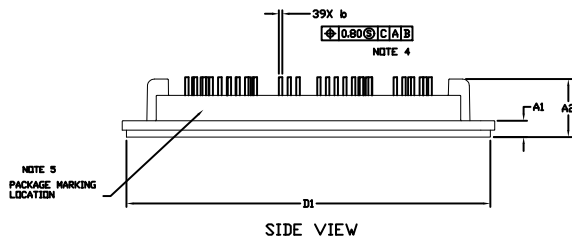

NOTE 4

PIN	PIN POSITION		PIN	PIN POSITION	
	X	Y		X	Y
1	35.00	-15.00	29	-32.50	-15.00
2	35.00	-18.00	30	-32.50	-18.00
3	32.50	-18.00	31	-35.00	-15.00
4	30.00	-18.00	32	-35.00	-18.00
5	27.50	-18.00	33	-29.25	1.45
6	25.00	-18.00	34	-29.25	4.45
7	17.75	-15.00	35	-22.90	4.70
8	17.75	-18.00	36	-15.75	4.85
9	15.25	-15.00	37	-17.15	1.85
10	15.25	-18.00	38	-33.00	18.00
11	8.00	-15.00	39	-30.50	18.00
12	8.00	-18.00	40	-28.00	18.00
13	5.50	-15.00	41	-25.50	18.00
14	5.50	-18.00	42	-23.00	18.00
15	3.00	-15.00	43	-20.50	18.00
16	3.00	-18.00	44	3.00	18.00
17	-3.00	-15.00	45	5.50	18.00
18	-3.00	-18.00	46	8.00	18.00
19	-5.50	-15.00	47	10.50	18.00
20	-5.50	-18.00	48	13.00	18.00
21	-8.00	-15.00	49	15.50	18.00
22	-8.00	-18.00	50	14.90	14.00
23	-15.25	-18.00	51	17.90	14.00
24	-17.75	-18.00	52	17.00	0.10
25	-20.25	-18.00	53	29.20	18.60
26	-22.75	-18.00	54	35.60	18.55
27	-30.00	-15.00	55	35.00	0.90
28	-30.00	-18.00	56	33.55	-2.10

MOUNTING HOLE POSITION

PIN	PIN POSITION		PIN	PIN POSITION	
	X	Y		X	Y
1	35.00	15.00	29	-32.50	15.00
2	35.00	18.00	30	-32.50	18.00
3	32.50	18.00	31	-35.00	15.00
4	30.00	18.00	32	-35.00	18.00
5	27.50	18.00	33	-29.25	-1.45
6	25.00	18.00	34	-29.25	-4.45
7	17.75	15.00	35	-22.90	-4.70
8	17.75	18.00	36	-15.75	-4.85
9	15.25	15.00	37	-17.15	-1.85
10	15.25	18.00	38	-33.00	-18.00
11	8.00	15.00	39	-30.50	-18.00
12	8.00	18.00	40	-28.00	-18.00
13	5.50	15.00	41	-25.50	-18.00
14	5.50	18.00	42	-23.00	-18.00
15	3.00	15.00	43	-20.50	-18.00
16	3.00	18.00	44	3.00	-18.00
17	-3.00	15.00	45	5.50	-18.00
18	-3.00	18.00	46	8.00	-18.00
19	-5.50	15.00	47	10.50	-18.00
20	-5.50	18.00	48	13.00	-18.00
21	-8.00	15.00	49	15.50	-18.00
22	-8.00	18.00	50	14.90	-14.00
23	-15.25	18.00	51	17.90	-14.00
24	-17.75	18.00	52	17.00	-0.10
25	-20.25	18.00	53	29.20	-18.60
26	-22.75	18.00	54	35.60	-18.55
27	-30.00	15.00	55	35.00	-0.90
28	-30.00	18.00	56	33.55	2.10

### GENERIC MARKING DIAGRAM\*

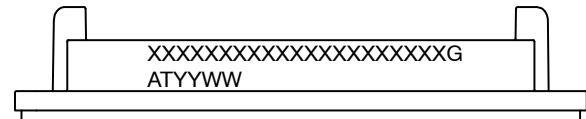

XXXXX = Specific Device Code  
G = Pb-Free Package  
AT = Assembly & Test Site Code  
YYWW = Year and Work Week Code

\*This information is generic. Please refer to device data sheet for actual part marking. Pb-Free indicator, "G" or microdot "▪", may or may not be present. Some products may not follow the Generic Marking.

DOCUMENT NUMBER:	98AON63482G	Electronic versions are uncontrolled except when accessed directly from the Document Repository. Printed versions are uncontrolled except when stamped "CONTROLLED COPY" in red.
DESCRIPTION:	PIM56 93X47 (SOLDER PIN)	PAGE 1 OF 1

ON Semiconductor and ON are trademarks of Semiconductor Components Industries, LLC dba ON Semiconductor or its subsidiaries in the United States and/or other countries. ON Semiconductor reserves the right to make changes without further notice to any products herein. ON Semiconductor makes no warranty, representation or guarantee regarding the suitability of its products for any particular purpose, nor does ON Semiconductor assume any liability arising out of the application or use of any product or circuit, and specifically disclaims any and all liability, including without limitation special, consequential or incidental damages. ON Semiconductor does not convey any license under its patent rights nor the rights of others.

**onsemi**, **Onsemi**, and other names, marks, and brands are registered and/or common law trademarks of Semiconductor Components Industries, LLC dba "**onsemi**" or its affiliates and/or subsidiaries in the United States and/or other countries. **onsemi** owns the rights to a number of patents, trademarks, copyrights, trade secrets, and other intellectual property. A listing of **onsemi**'s product/patent coverage may be accessed at [www.onsemi.com/site/pdf/Patent-Marking.pdf](http://www.onsemi.com/site/pdf/Patent-Marking.pdf). **onsemi** reserves the right to make changes at any time to any products or information herein, without notice. The information herein is provided "as-is" and **onsemi** makes no warranty, representation or guarantee regarding the accuracy of the information, product features, availability, functionality, or suitability of its products for any particular purpose, nor does **onsemi** assume any liability arising out of the application or use of any product or circuit, and specifically disclaims any and all liability, including without limitation special, consequential or incidental damages. Buyer is responsible for its products and applications using **onsemi** products, including compliance with all laws, regulations and safety requirements or standards, regardless of any support or applications information provided by **onsemi**. "Typical" parameters which may be provided in **onsemi** data sheets and/or specifications can and do vary in different applications and actual performance may vary over time. All operating parameters, including "Typicals" must be validated for each customer application by customer's technical experts. **onsemi** does not convey any license under any of its intellectual property rights nor the rights of others. **onsemi** products are not designed, intended, or authorized for use as a critical component in life support systems or any FDA Class 3 medical devices or medical devices with a same or similar classification in a foreign jurisdiction or any devices intended for implantation in the human body. Should Buyer purchase or use **onsemi** products for any such unintended or unauthorized application, Buyer shall indemnify and hold **onsemi** and its officers, employees, subsidiaries, affiliates, and distributors harmless against all claims, costs, damages, and expenses, and reasonable attorney fees arising out of, directly or indirectly, any claim of personal injury or death associated with such unintended or unauthorized use, even if such claim alleges that **onsemi** was negligent regarding the design or manufacture of the part. **onsemi** is an Equal Opportunity/Affirmative Action Employer. This literature is subject to all applicable copyright laws and is not for resale in any manner.

## ADDITIONAL INFORMATION

### TECHNICAL PUBLICATIONS:

Technical Library: [www.onsemi.com/design/resources/technical-documentation](http://www.onsemi.com/design/resources/technical-documentation)  
onsemi Website: [www.onsemi.com](http://www.onsemi.com)

### ONLINE SUPPORT: [www.onsemi.com/support](http://www.onsemi.com/support)

For additional information, please contact your local Sales Representative at [www.onsemi.com/support/sales](http://www.onsemi.com/support/sales)