

Overview

The KEMET SS coils are common mode chokes with a wide variety of characteristics. These gear type coils are designed with our proprietary ferrite cores and are useful in various noise countermeasure fields.

Applications

- Audio-visual equipment
- Office automation equipment
- Digital appliances
- Power supplies

Benefits

- Proprietary 5H and 10H ferrite materials and equivalents
- Suitable for ≥ 150 kHz range
- Wide variety of sizes and specifications
- Operating temperature range from -25°C to $+120^{\circ}\text{C}$
- UL 94 V-0 flame retardant rated base and bobbin



Part Number System

SS	30	V-	R	08	0960
Series	Core Size Code	Core Orientation	Core Type	Rated Current (A)	Inductance (mH) Minimum
SS	30	V = Vertical	Blank = Standard R = High permeability	0x = 0.x A xx = x.x A Examples: 08 = 0.8 A 25 = 2.5 A	0xxx = xx mH 00xx = x.x mH Examples: 0960 = 96 mH 0028 = 2.8 mH

Magnetic Permeability of Ferrite Material

In order to achieve most efficient noise reduction, it is important to select the material according to the target frequency band. Depending on its magnetic permeability, a particular ferrite material will be effective in a certain frequency band. A schematic representation of the relationship between the magnetic permeability of each material and the corresponding effective band range is shown in Figure 1. Materials with higher magnetic permeability are effective in the lower frequency range, while those with lower magnetic permeability are effective in the higher frequency range. Thus, Mn-Zn products are mainly used for reducing conduction noise, while Ni-Zn products are commonly used for radiation noise countermeasures.

The effective frequency range varies depending on core shape, size and number of windings. This frequency dependence of the magnetic permeability as shown in the figure serves for reference purposes only and it should be tested on the actual device to determine its effectiveness.

S18H, S15H, 10H, 7H, 5H, 1400L and 700L are KEMET's proprietary ferrite material names. Other materials can also be available on request.

Figure 1 - Relationship between the magnetic permeability of each material and its effective frequency range



Dimensions – Millimeters

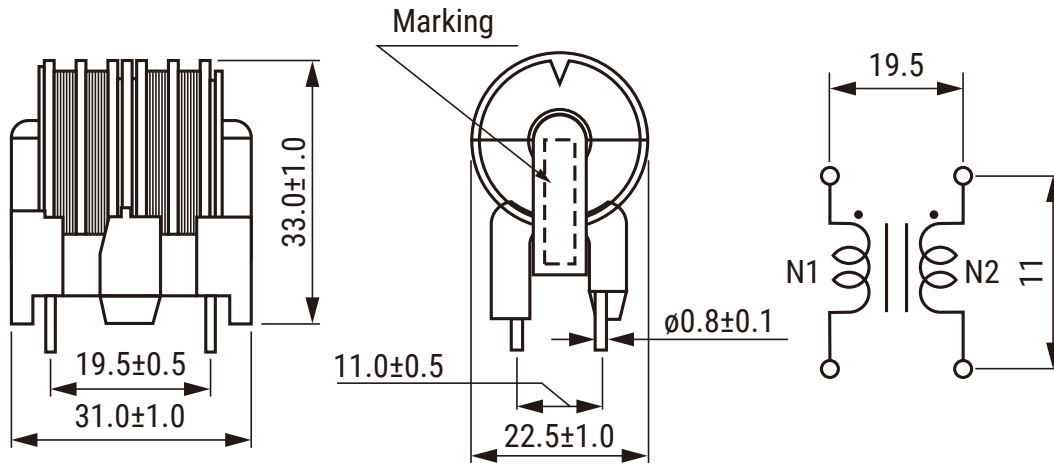

Environmental Compliance

All KEMET AC Line Filters are RoHS Compliant.



Performance Characteristics

Item	Performance Characteristics
Rated Voltage	250 VAC
Withstanding Voltage	2,400 VAC (2 seconds, between lines)
Insulation Resistance	> 100 MΩ at 500 VDC (between lines)
Rated Current Range	0.8 – 4.5 A
Rated Inductance Range	1.3 – 96.0 mH minimum
Inductance Measurement Condition	1 kHz
Thermal Class	E (120°C)
Operating Temperature Range	-25°C to +120°C (include self temperature rise)

Table 1 – Ratings & Part Number Reference

Part Number	Rated Current (A)	Inductance (mH) Minimum	DC Resistance/ Line (Ω) Maximum	Temperature Rise (K) Maximum	Marking	Weight (g) Approximate
SS30V-080730	0.8	73.0	1.50	50	08 Lot No.	35.1
SS30V-100530	1.0	53.0	1.10	50	10 Lot No.	36.8
SS30V-120290	1.2	29.0	0.60	45	12 Lot No.	35.0
SS30V-150200	1.5	20.0	0.50	45	15 Lot No.	35.3
SS30V-180145	1.8	14.5	0.23	50	18 Lot No.	35.2
SS30V-200100	2.0	10.0	0.21	45	20 Lot No.	34.9
SS30V-250070	2.5	7.0	0.16	45	25 Lot No.	34.1
SS30V-300054	3.0	5.4	0.12	45	30 Lot No.	34.6
SS30V-350036	3.5	3.6	0.10	50	35 Lot No.	30.6
SS30V-400021	4.0	2.1	0.07	50	40 Lot No.	29.0
SS30V-450013	4.5	1.3	0.06	50	45 Lot No.	26.1
SS30V-R080960	0.8	96.0	1.50	50	R08 Lot No.	35.1
SS30V-R100700	1.0	70.0	1.10	50	R10 Lot No.	36.8
SS30V-R120380	1.2	38.0	0.60	45	R12 Lot No.	35.0
SS30V-R150270	1.5	27.0	0.50	45	R15 Lot No.	35.3
SS30V-R180190	1.8	19.0	0.23	50	R18 Lot No.	35.2
SS30V-R200132	2.0	13.2	0.21	45	R20 Lot No.	34.9
SS30V-R250092	2.5	9.2	0.16	45	R25 Lot No.	34.1
SS30V-R300071	3.0	7.1	0.12	45	R30 Lot No.	34.6
SS30V-R350047	3.5	4.7	0.10	50	R35 Lot No.	30.6
SS30V-R400028	4.0	2.8	0.07	50	R40 Lot No.	29.0
SS30V-R450017	4.5	1.7	0.06	50	R45 Lot No.	26.1

Frequency Characteristics

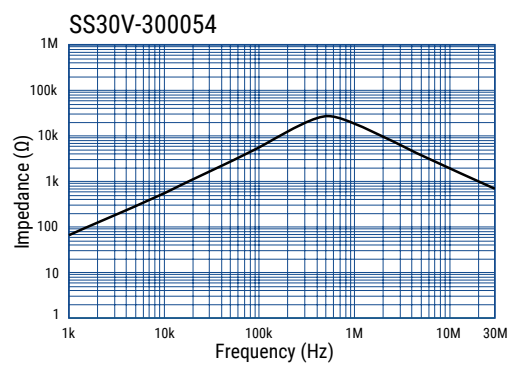
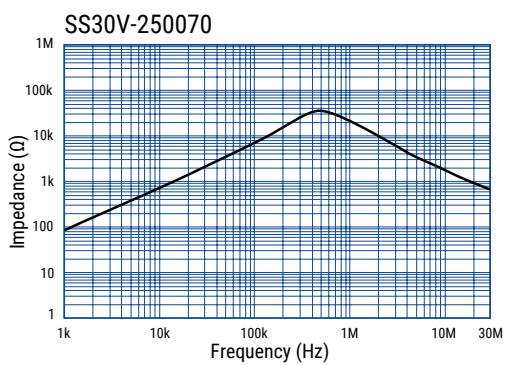
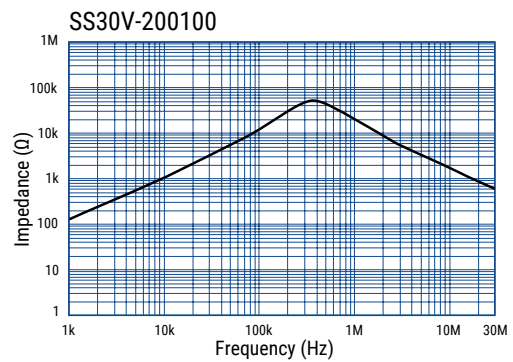
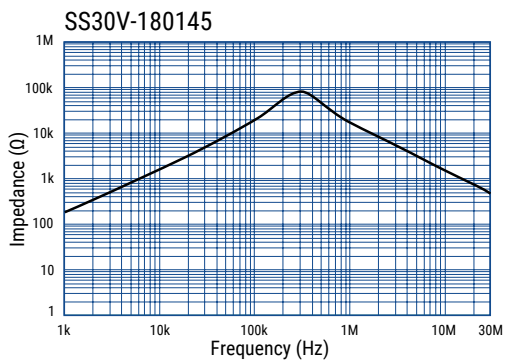
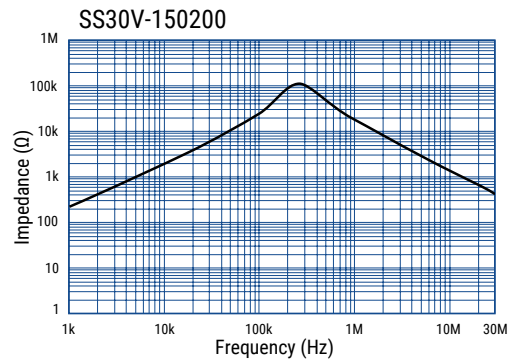
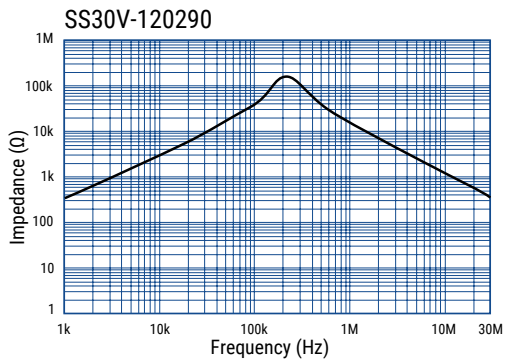
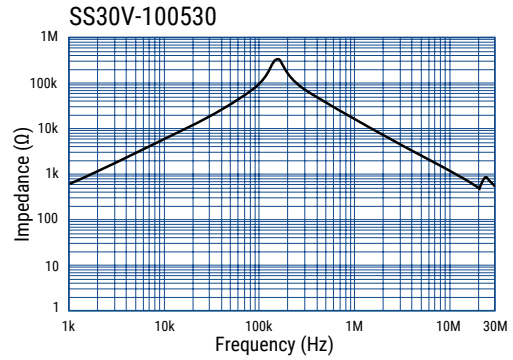
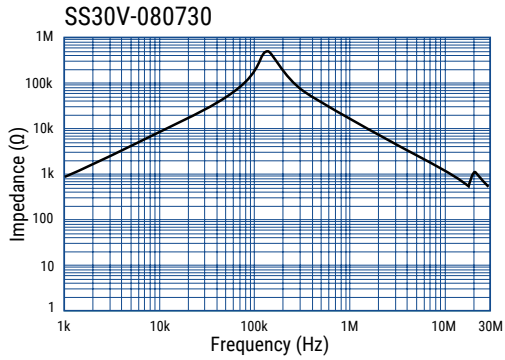

Frequency Characteristics cont.

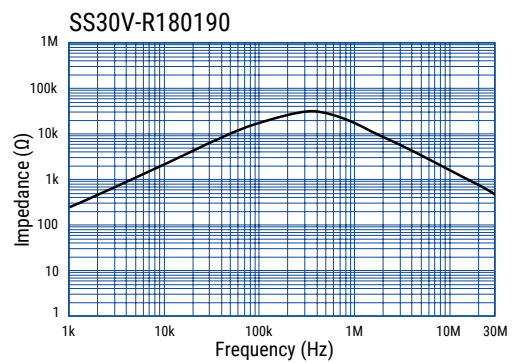
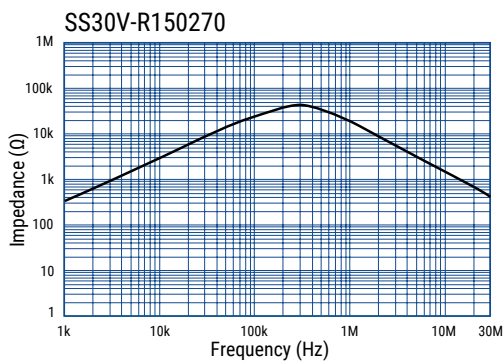
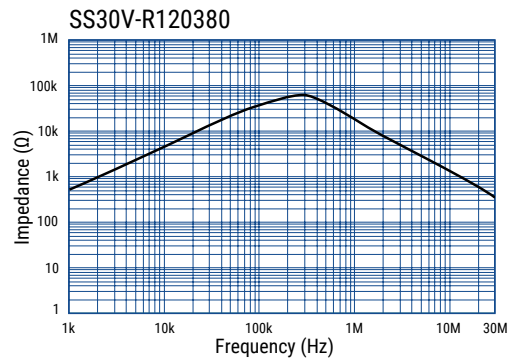
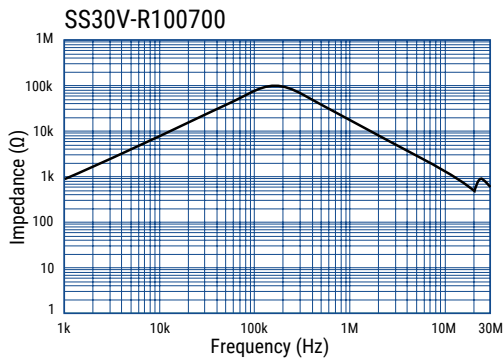
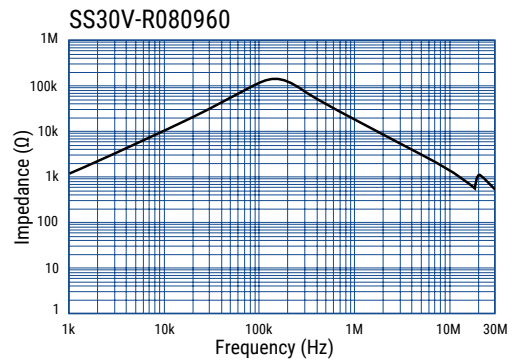
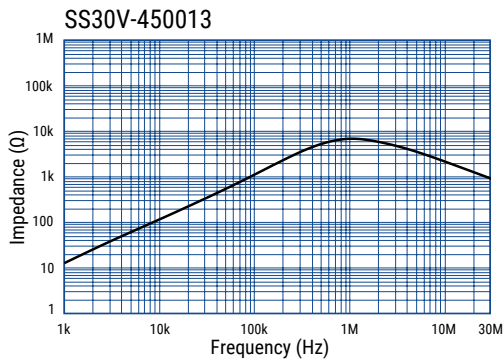
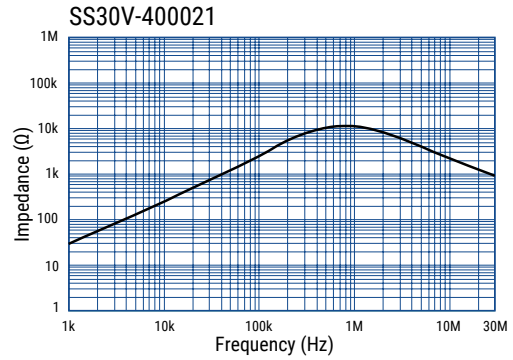
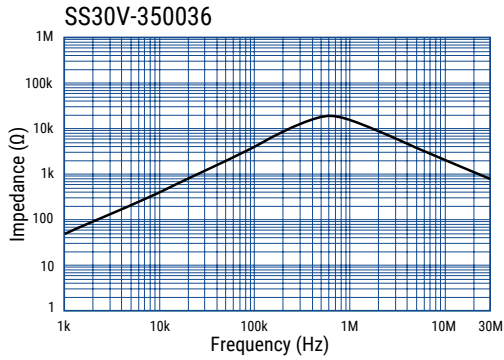

Frequency Characteristics cont.

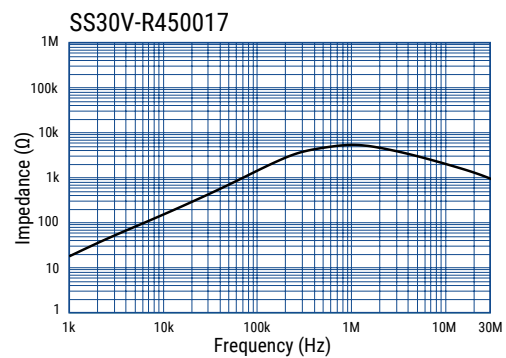
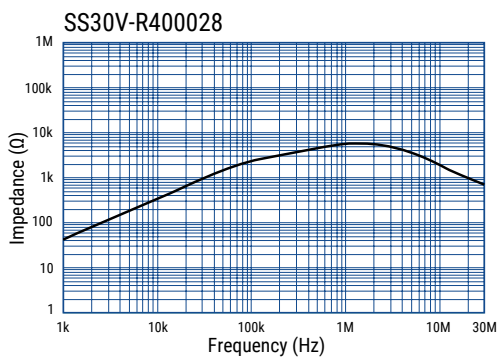
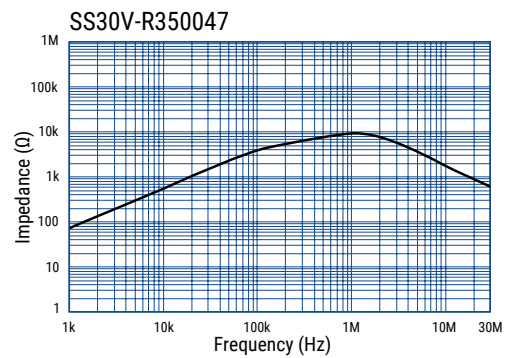
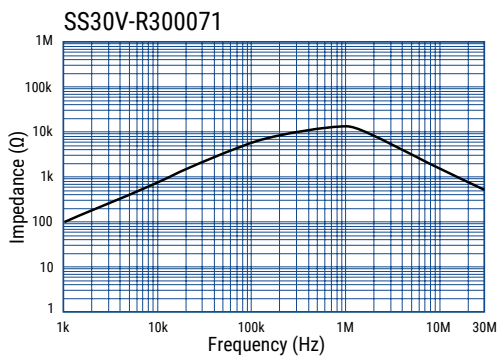
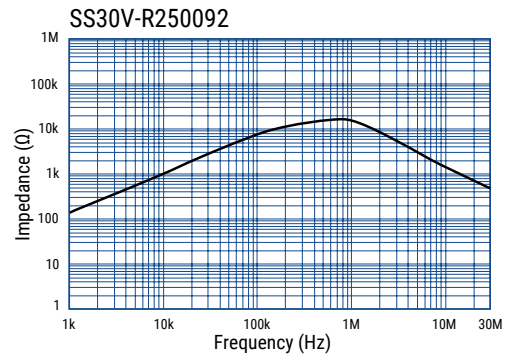
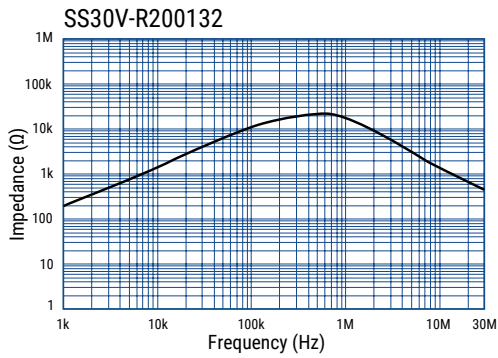

Packaging

Type	Packaging Type	Pieces Per Box
SS30V	Tray	200

Handling Precautions

Precautions for product storage

AC Line Filters should be stored in normal working environments. While the chokes themselves are quite robust in other environments, solderability will be degraded by exposure to high temperatures, high humidity, corrosive atmospheres, and long term storage.

KEMET recommends that maximum storage temperature not exceed 40°C and maximum storage humidity not exceed 70% relative humidity. Atmospheres should be free of chlorine and sulfur bearing compounds. Temperature fluctuations should be minimized to avoid condensation on the parts. Avoid storage near strong magnetic fields, as this might magnetize the product.

For optimized solderability, AC line filters stock should be used promptly and preferably within 6 months of receipt.

Product temperature rise values

The values listed for temperature rise are the result of self-heating in wires when the rated current (commercial frequency) is applied.

When using the product, check and evaluate the value of the core temperature rise under actual operating conditions.

KEMET Electronics Corporation Sales Offices

For a complete list of our global sales offices, please visit www.kemet.com/sales.

Disclaimer

All product specifications, statements, information and data (collectively, the "Information") in this datasheet are subject to change. The customer is responsible for checking and verifying the extent to which the Information contained in this publication is applicable to an order at the time the order is placed. All Information given herein is believed to be accurate and reliable, but it is presented without guarantee, warranty, or responsibility of any kind, expressed or implied.

Statements of suitability for certain applications are based on KEMET Electronics Corporation's ("KEMET") knowledge of typical operating conditions for such applications, but are not intended to constitute – and KEMET specifically disclaims – any warranty concerning suitability for a specific customer application or use. The Information is intended for use only by customers who have the requisite experience and capability to determine the correct products for their application. Any technical advice inferred from this Information or otherwise provided by KEMET with reference to the use of KEMET's products is given gratis, and KEMET assumes no obligation or liability for the advice given or results obtained.

Although KEMET designs and manufactures its products to the most stringent quality and safety standards, given the current state of the art, isolated component failures may still occur. Accordingly, customer applications which require a high degree of reliability or safety should employ suitable designs or other safeguards (such as installation of protective circuitry or redundancies) in order to ensure that the failure of an electrical component does not result in a risk of personal injury or property damage.

Although all product-related warnings, cautions and notes must be observed, the customer should not assume that all safety measures are indicated or that other measures may not be required.

When providing KEMET products and technologies contained herein to other countries, the customer must abide by the procedures and provisions stipulated in all applicable export laws and regulations, including without limitation the US Export Administration Regulations and the Japan Foreign Exchange and Foreign Trade Act.

KEMET is a registered trademark of KEMET Electronics Corporation.