

Features

- 10 dB Coupling Ratio
- Surface Mount
- Available on Tape and Reel
- Excellent Temperature Stability
- RoHS Compliant and lead free
- 260°C Reflow Compatible



Description

The MACP-011034 is a 10 dB coupler in a low cost, surface mount package. Ideally suited for broadband CATV applications.

Functional Schematic

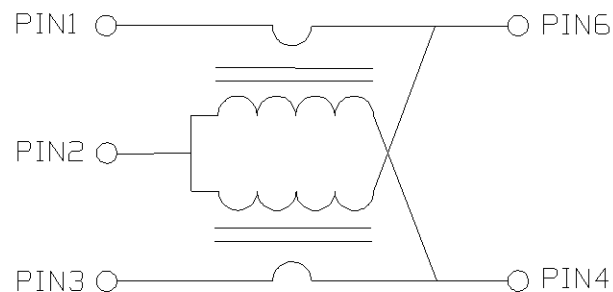

Ordering Information

Part Number	Description
MACP-011034	900 piece reel
MACP-011034-TB	Sample Test Board

Pin Configuration

Pin No.	Function
1	Input
2	Ground
3	Coupled
4	Isolated
5	Not Connected
6	Output

10 dB Coupler
5 - 1225 MHz

Rev. V2

Electrical Specifications: Freq. = 5 - 1225 MHz, $T_A = 25^\circ\text{C}$, $Z_0 = 75 \Omega$, $P_{in} = 0 \text{ dBm}$

Parameter	Conditions	Units	Min.	Typ.	Max.
Coupling Ratio	—	dB	—	10	—
Coupling (Pin 1- Pin 3)	5 - 1225 MHz	dB	10.6	10.0	9.4
Main Line Loss (Pin 1- Pin 6)	5 - 1000 MHz 1000 - 1225 MHz	dB	—	1.35 1.65	1.5 1.8
Isolation (Pin 1- Pin 4)	5 - 500 MHz 500 - 1225 MHz	dB	28 19	30 21	—
Input Return Loss (Pin 1)	5 - 500 MHz 500 - 1225 MHz	dB	17 12	19 15	—
Output Return Loss (Pin 6)	5 - 500 MHz 500 - 1225 MHz	dB	17 12	20 14	—
Coupling Return Loss (Pin 3)	5 - 50 MHz 50 - 1225 MHz	dB	11 15	13 17	—

Absolute Maximum Ratings

Parameter	Absolute Maximum
Input Power	0.5 W
DC Current	500 mA
Operating Temperature	-40°C to $+85^\circ\text{C}$

Application Schematic

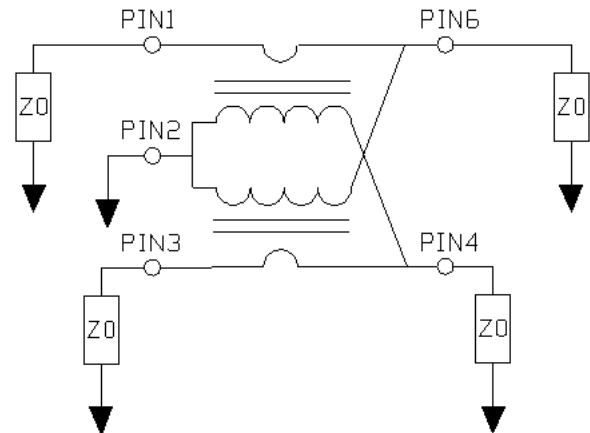

Typical Performance Curves¹

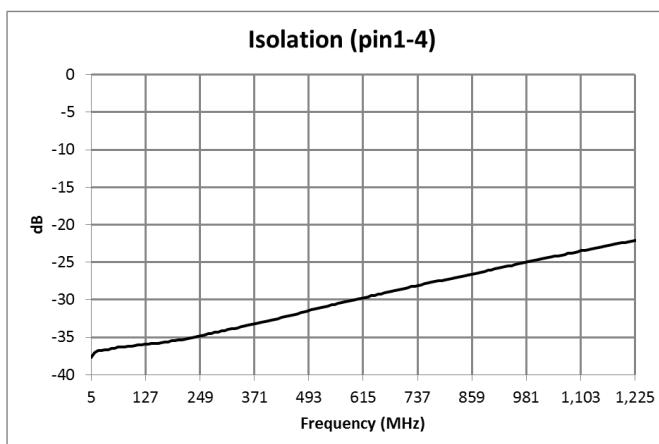
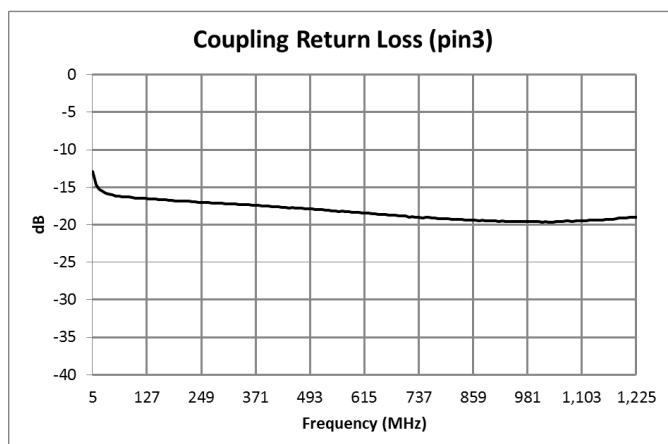
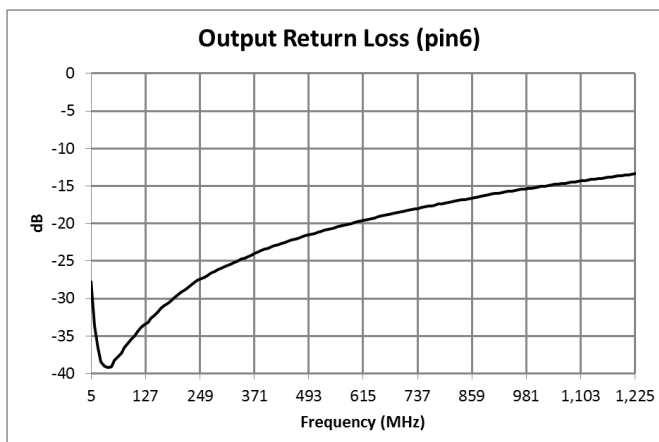
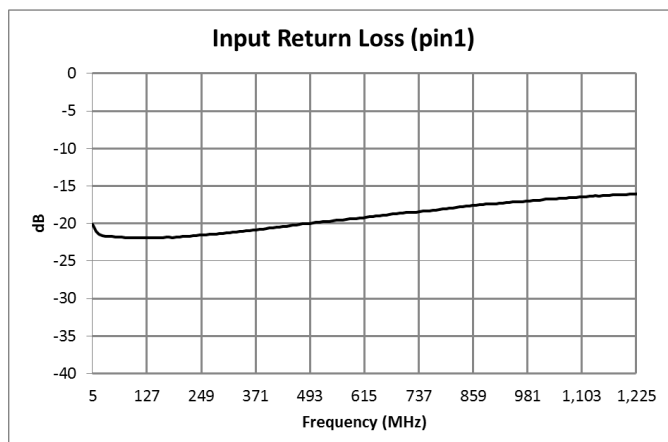
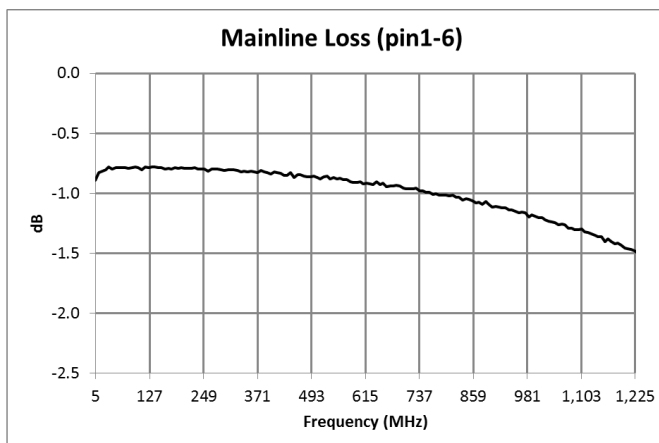
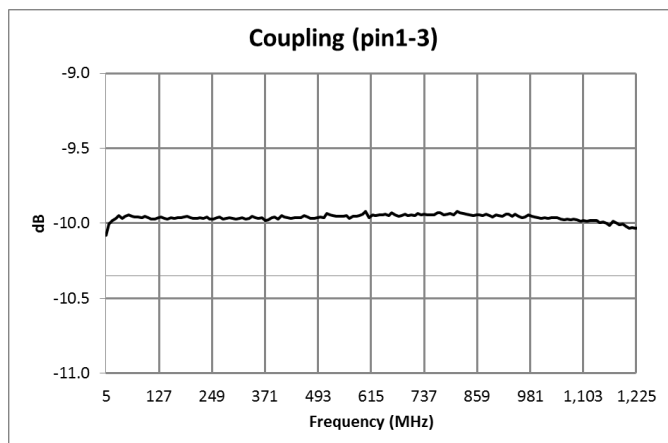

1. Full temperature plots available on request.

Outline Drawing

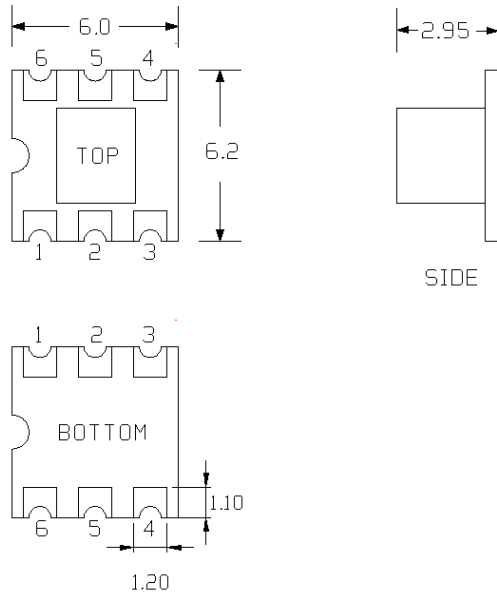

PCB Layout

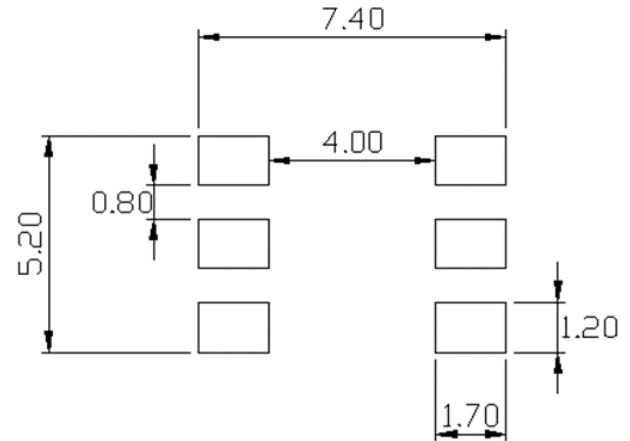

1. Dimensions in mm.
2. Tolerance: ± 0.2 mm unless otherwise noted.
3. Model number and lot code printed on reel.
4. Plating finish: ENIG on both sides, 0.05 to 0.1 μ m gold over 3 to 6 μ m nickel

Carrier Tape Orientation

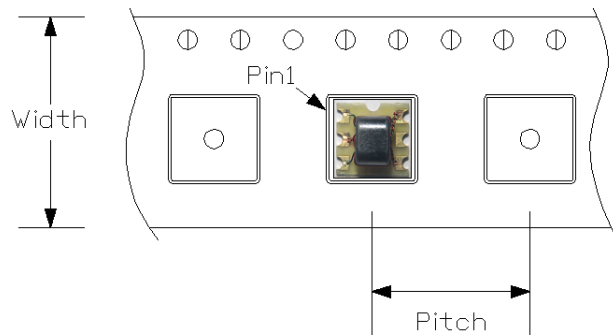

Tape & Reel Information

Parameter	Units	Value
Qty per reel	-	900
Reel Size	mm	330
Tape Width	mm	16.00
Pitch	mm	12.00
Orientation	-	F45
Reference Application Note ANI-019 for orientation		

MACOM Technology Solutions Inc. All rights reserved.

Information in this document is provided in connection with MACOM Technology Solutions Inc ("MACOM") products. These materials are provided by MACOM as a service to its customers and may be used for informational purposes only. Except as provided in MACOM's Terms and Conditions of Sale for such products or in any separate agreement related to this document, MACOM assumes no liability whatsoever. MACOM assumes no responsibility for errors or omissions in these materials. MACOM may make changes to specifications and product descriptions at any time, without notice. MACOM makes no commitment to update the information and shall have no responsibility whatsoever for conflicts or incompatibilities arising from future changes to its specifications and product descriptions. No license, express or implied, by estoppel or otherwise, to any intellectual property rights is granted by this document.

THESE MATERIALS ARE PROVIDED "AS IS" WITHOUT WARRANTY OF ANY KIND, EITHER EXPRESS OR IMPLIED, RELATING TO SALE AND/OR USE OF MACOM PRODUCTS INCLUDING LIABILITY OR WARRANTIES RELATING TO FITNESS FOR A PARTICULAR PURPOSE, CONSEQUENTIAL OR INCIDENTAL DAMAGES, MERCHANTABILITY, OR INFRINGEMENT OF ANY PATENT, COPYRIGHT OR OTHER INTELLECTUAL PROPERTY RIGHT. MACOM FURTHER DOES NOT WARRANT THE ACCURACY OR COMPLETENESS OF THE INFORMATION, TEXT, GRAPHICS OR OTHER ITEMS CONTAINED WITHIN THESE MATERIALS. MACOM SHALL NOT BE LIABLE FOR ANY SPECIAL, INDIRECT, INCIDENTAL, OR CONSEQUENTIAL DAMAGES, INCLUDING WITHOUT LIMITATION, LOST REVENUES OR LOST PROFITS, WHICH MAY RESULT FROM THE USE OF THESE MATERIALS.

MACOM products are not intended for use in medical, lifesaving or life sustaining applications. MACOM customers using or selling MACOM products for use in such applications do so at their own risk and agree to fully indemnify MACOM for any damages resulting from such improper use or sale.