



# STGB19NC60W STGP19NC60W, STGW19NC60W

19 A - 600 V - ultra fast IGBT

## Features

- High frequency operation
- Low  $C_{RES} / C_{IES}$  ratio (no cross-conduction susceptibility)

## Applications

- High frequency motor controls, inverters, UPS
- HF, SMPS and PFC in both hard switch and resonant topologies

## Description

This IGBT utilizes the advanced PowerMESH™ process resulting in an excellent trade-off between switching performance and low on-state behavior.

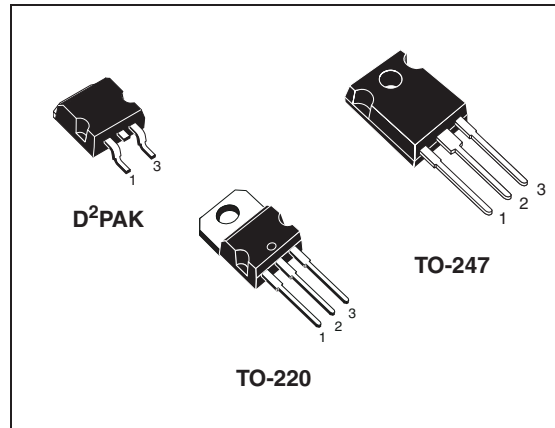

Figure 1. Internal schematic diagram

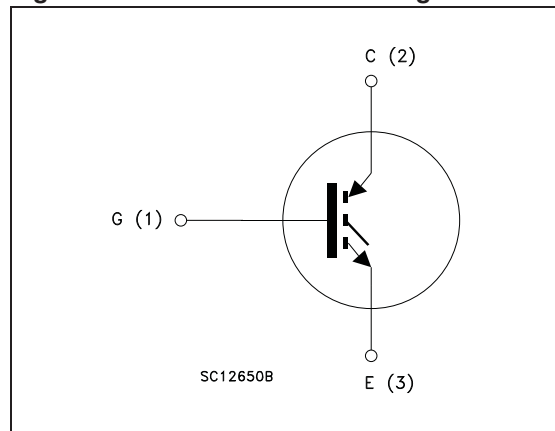

Table 1. Device summary

Order codes	Marking	Package	Packaging
STGB19NC60WT4	GB19NC60W	D <sup>2</sup> PAK	Tape and reel
STGP19NC60W	P19NC60W	TO-220	Tube
STGW19NC60W	W19NC60W	TO-247	Tube

## Contents

<b>1</b>	<b>Electrical ratings</b> .....	<b>3</b>
<b>2</b>	<b>Electrical characteristics</b> .....	<b>4</b>
	2.1 Electrical characteristics (curves) .....	6
<b>3</b>	<b>Test circuit</b> .....	<b>9</b>
<b>4</b>	<b>Package mechanical data</b> .....	<b>10</b>
<b>5</b>	<b>Packaging mechanical data</b> .....	<b>14</b>
<b>6</b>	<b>Revision history</b> .....	<b>15</b>

# 1 Electrical ratings

**Table 2. Absolute maximum ratings**

Symbol	Parameter	Value		Unit
		D <sup>2</sup> PAK TO-220	TO-247	
V <sub>CES</sub>	Collector-emitter voltage (V <sub>GE</sub> = 0)	600		V
I <sub>C</sub> <sup>(1)</sup>	Collector current (continuous) at T <sub>C</sub> = 25°C	40	42	A
I <sub>C</sub> <sup>(1)</sup>	Collector current (continuous) at T <sub>C</sub> = 100°C	22	23	A
I <sub>CL</sub> <sup>(2)</sup>	Turn-off latching current	30		A
V <sub>GE</sub>	Gate-emitter voltage	±20		V
P <sub>TOT</sub>	Total dissipation at T <sub>C</sub> = 25°C	130	140	W
T <sub>j</sub>	Operating junction temperature	-65 to 150		°C

1. Calculated according to the iterative formula:

$$I_C(T_C) = \frac{T_{j(max)} - T_C}{R_{thj-c} \times V_{CE(sat)(max)}(T_{j(max)}, I_C(T_C))}$$

2. V<sub>CLAMP</sub> = 80% (V<sub>CES</sub>), V<sub>GE</sub> = 15 V, R<sub>G</sub> = 10 Ω, T<sub>J</sub> = 150 °C

**Table 3. Thermal resistance**

Symbol	Parameter	Value		Unit
		D <sup>2</sup> PAK TO-220	TO-247	
R <sub>thj-case</sub>	Thermal resistance junction-case max	0.95	0.9	°C/W
R <sub>thj-amb</sub>	Thermal resistance junction-ambient max	62.5	50	°C/W

## 2 Electrical characteristics

( $T_{CASE}=25^{\circ}\text{C}$  unless otherwise specified)

**Table 4. Static**

Symbol	Parameter	Test conditions	Min.	Typ.	Max.	Unit
$V_{(BR)CES}$	Collector-emitter breakdown voltage ( $V_{GE}=0$ )	$I_C=1\text{ mA}$	600			V
$V_{CE(sat)}$	Collector-emitter saturation voltage	$V_{GE}=15\text{ V}$ , $I_C=12\text{ A}$ $V_{GE}=15\text{ V}$ , $I_C=12\text{ A}$ , $T_C=125^{\circ}\text{C}$		2.1 1.8	2.5	V V
$V_{GE(th)}$	Gate threshold voltage	$V_{CE}=V_{GE}$ , $I_C=250\text{ }\mu\text{A}$	3.75		5.75	V
$I_{CES}$	Collector cut-off current ( $V_{GE}=0$ )	$V_{CE}=600\text{ V}$ $V_{CE}=600\text{ V}$ , $T_C=125^{\circ}\text{C}$			150 1	$\mu\text{A}$ mA
$I_{GES}$	Gate-emitter leakage current ( $V_{CE}=0$ )	$V_{GE}=\pm 20\text{ V}$			$\pm 100$	nA
$g_{fs}$	Forward transconductance	$V_{CE}=15\text{ V}$ , $I_C=12\text{ A}$		10		S

**Table 5. Dynamic**

Symbol	Parameter	Test conditions	Min.	Typ.	Max.	Unit
$C_{ies}$	Input capacitance	$V_{CE}=25\text{ V}$ , $f=1\text{ MHz}$ , $V_{GE}=0$		1180		pF
$C_{oes}$	Output capacitance			130		pF
$C_{res}$	Reverse transfer capacitance			26		pF
$Q_g$	Total gate charge	$V_{CE}=390\text{ V}$ , $I_C=12\text{ A}$ ,		53		nC
$Q_{ge}$	Gate-emitter charge	$V_{GE}=15\text{ V}$ ,		10		nC
$Q_{gc}$	Gate-collector charge	<a href="#">Figure 16</a>		21		nC

Table 6. Switching on/off (inductive load)

Symbol	Parameter	Test conditions	Min.	Typ.	Max.	Unit
$t_{d(on)}$	Turn-on delay time	$V_{CC} = 390\text{ V}$ , $I_C = 12\text{ A}$		25		ns
$t_r$	Current rise time	$R_G = 10\ \Omega$ , $V_{GE} = 15\text{ V}$ ,		7		ns
$(di/dt)_{on}$	Turn-on current slope	<i>Figure 17</i>		1600		A/ $\mu$ s
$t_{d(on)}$	Turn-on delay time	$V_{CC} = 390\text{ V}$ , $I_C = 12\text{ A}$		25		ns
$t_r$	Current rise time	$R_G = 10\ \Omega$ , $V_{GE} = 15\text{ V}$ ,		8		ns
$(di/dt)_{on}$	Turn-on current slope	$T_C = 125^\circ\text{C}$ <i>Figure 17</i>		1400		A/ $\mu$ s
$t_r(V_{off})$	Off voltage rise time	$V_{CC} = 390\text{ V}$ , $I_C = 12\text{ A}$		22		ns
$t_{d(off)}$	Turn-off delay time	$R_G = 10\ \Omega$ , $V_{GE} = 15\text{ V}$ ,		90		ns
$t_f$	Current fall time	<i>Figure 17</i>		43		ns
$t_r(V_{off})$	Off voltage rise time	$V_{CC} = 390\text{ V}$ , $I_C = 12\text{ A}$		47		ns
$t_{d(off)}$	Turn-off delay time	$R_G = 10\ \Omega$ , $V_{GE} = 15\text{ V}$ ,		127		ns
$t_f$	Current fall time	$T_C = 125^\circ\text{C}$ <i>Figure 17</i>		77		ns

Table 7. Switching energy (inductive load)

Symbol	Parameter	Test conditions	Min.	Typ.	Max.	Unit
$E_{on}^{(1)}$	Turn-on switching losses	$V_{CC} = 390\text{ V}$ , $I_C = 12\text{ A}$		81		$\mu$ J
$E_{off}^{(2)}$	Turn-off switching losses	$R_G = 10\ \Omega$ , $V_{GE} = 15\text{ V}$ ,		125		$\mu$ J
$E_{ts}$	Total switching losses	<i>Figure 17</i>		206		$\mu$ J
$E_{on}^{(1)}$	Turn-on switching losses	$V_{CC} = 390\text{ V}$ , $I_C = 12\text{ A}$		161		$\mu$ J
$E_{off}^{(2)}$	Turn-off switching losses	$R_G = 10\ \Omega$ , $V_{GE} = 15\text{ V}$ ,		255		$\mu$ J
$E_{ts}$	Total switching losses	$T_C = 125^\circ\text{C}$ <i>Figure 17</i>		416		$\mu$ J

1.  $E_{on}$  is the turn-on losses when a typical diode is used in the test circuit in *Figure 15*. If the IGBT is offered in a package with a co-pak diode, the co-pak diode is used as external diode. IGBTs & Diode are at the same temperature (25°C and 125°C)

2. Turn-off losses include also the tail of the collector current

## 2.1 Electrical characteristics (curves)

Figure 2. Output characteristics

Figure 3. Transfer characteristics

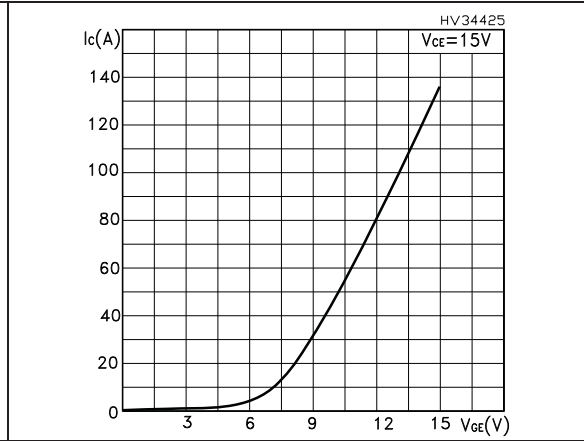
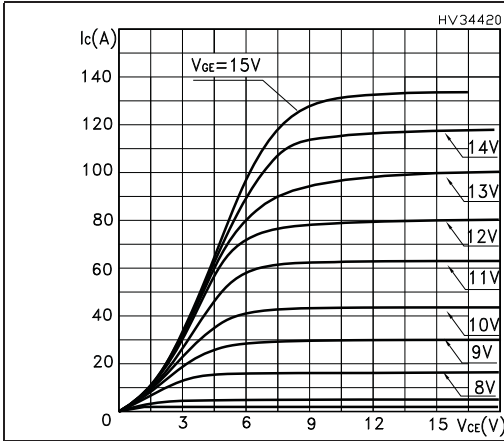

Figure 4. Transconductance

Figure 5. Collector-emitter on voltage vs temperature

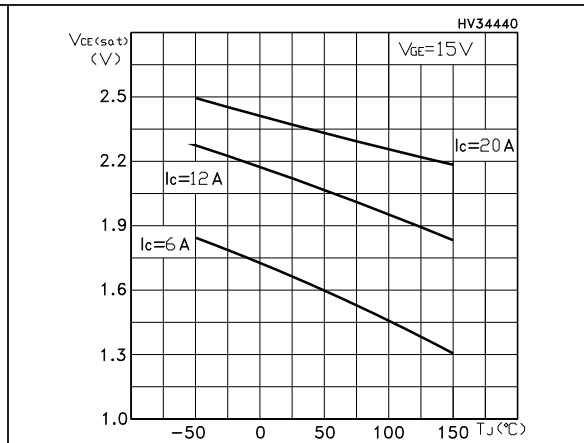
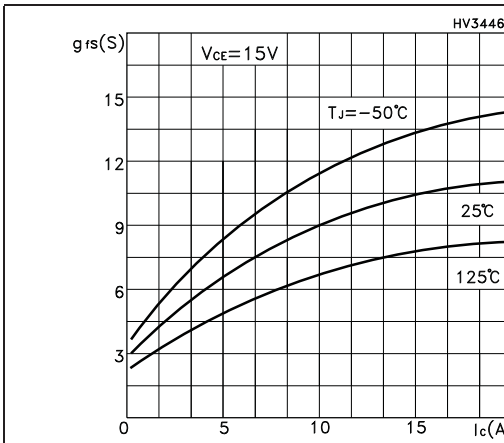

Figure 6. Gate charge vs gate-source voltage Figure 7. Capacitance variations

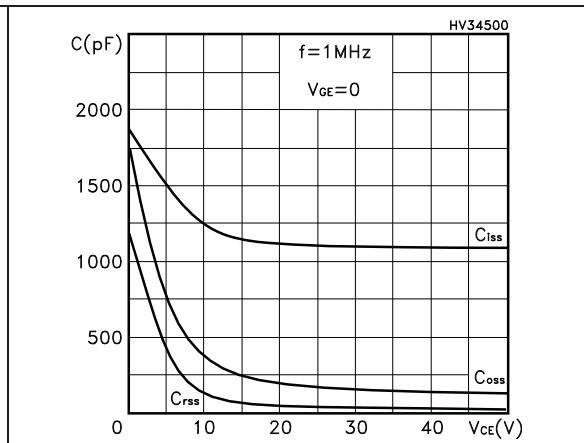
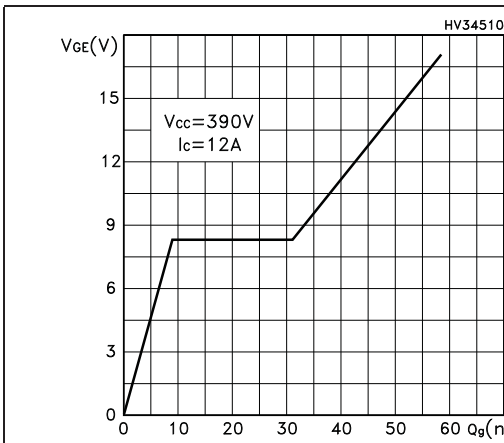

Figure 8. Normalized gate threshold voltage vs temperature

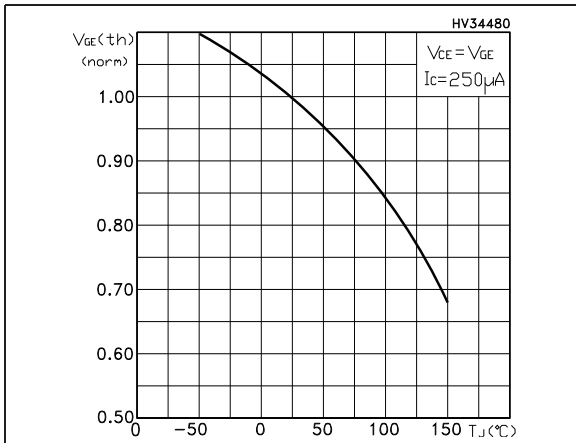

Figure 9. Collector-emitter on voltage vs collector current

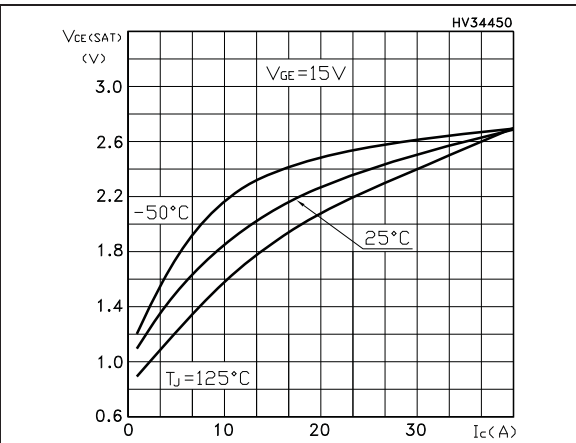

Figure 10. Normalized breakdown voltage vs temperature

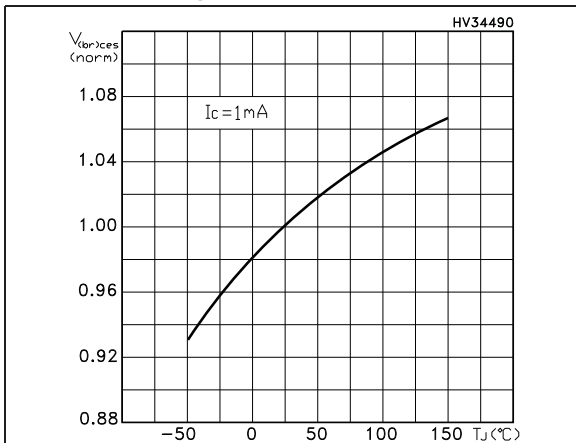

Figure 11. Switching losses vs temperature

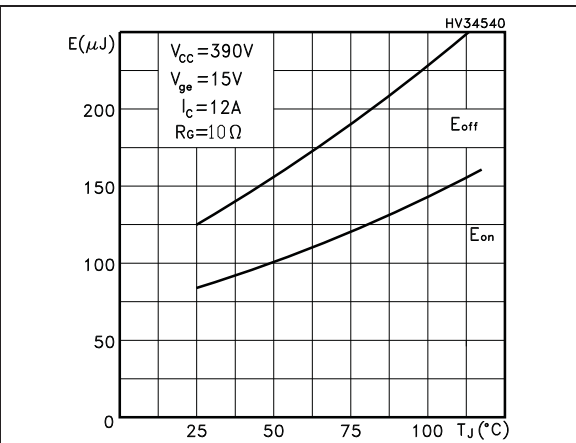

Figure 12. Switching losses vs gate resistance

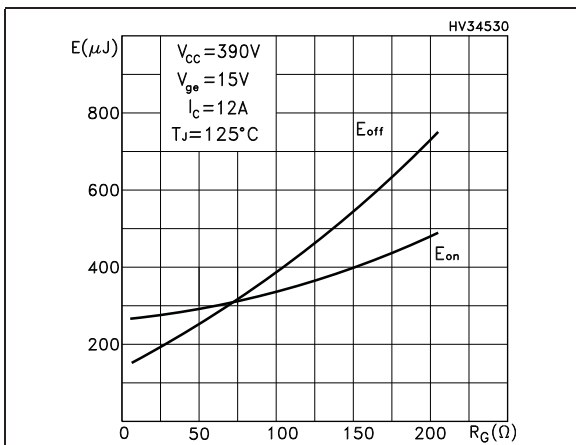

Figure 13. Switching losses vs collector current

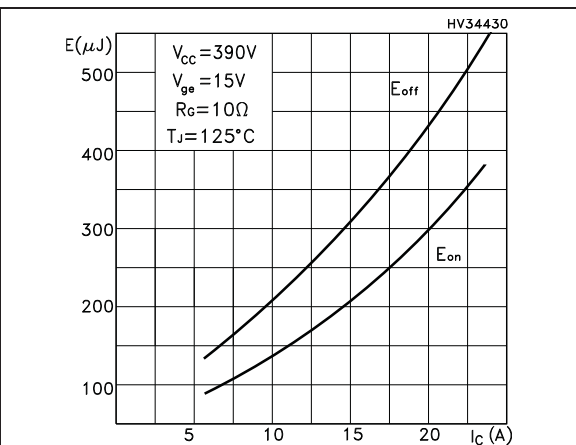
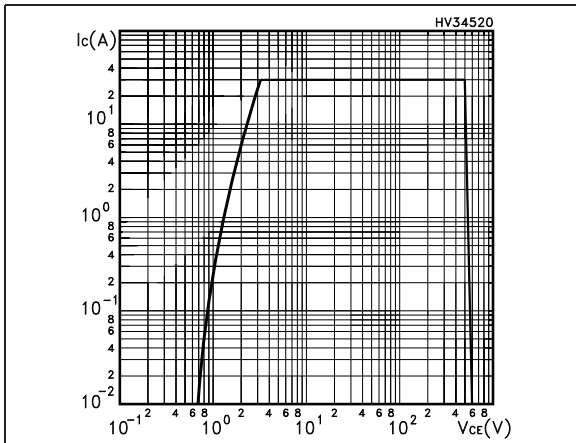

Figure 14. Turn-off SOA







## 4 Package mechanical data

In order to meet environmental requirements, ST offers these devices in ECOPACK® packages. These packages have a lead-free second level interconnect. The category of second level interconnect is marked on the package and on the inner box label, in compliance with JEDEC Standard JESD97. The maximum ratings related to soldering conditions are also marked on the inner box label. ECOPACK is an ST trademark. ECOPACK specifications are available at: [www.st.com](http://www.st.com)

D<sup>2</sup>PAK (TO-263) mechanical data

Dim	mm			inch		
	Min	Typ	Max	Min	Typ	Max
A	4.40		4.60	0.173		0.181
A1	0.03		0.23	0.001		0.009
b	0.70		0.93	0.027		0.037
b2	1.14		1.70	0.045		0.067
c	0.45		0.60	0.017		0.024
c2	1.23		1.36	0.048		0.053
D	8.95		9.35	0.352		0.368
D1	7.50			0.295		
E	10		10.40	0.394		0.409
E1	8.50			0.334		
e		2.54			0.1	
e1	4.88		5.28	0.192		0.208
H	15		15.85	0.590		0.624
J1	2.49		2.69	0.099		0.106
L	2.29		2.79	0.090		0.110
L1	1.27		1.40	0.05		0.055
L2	1.30		1.75	0.051		0.069
R		0.4			0.016	
V2	0°		8°	0°		8°

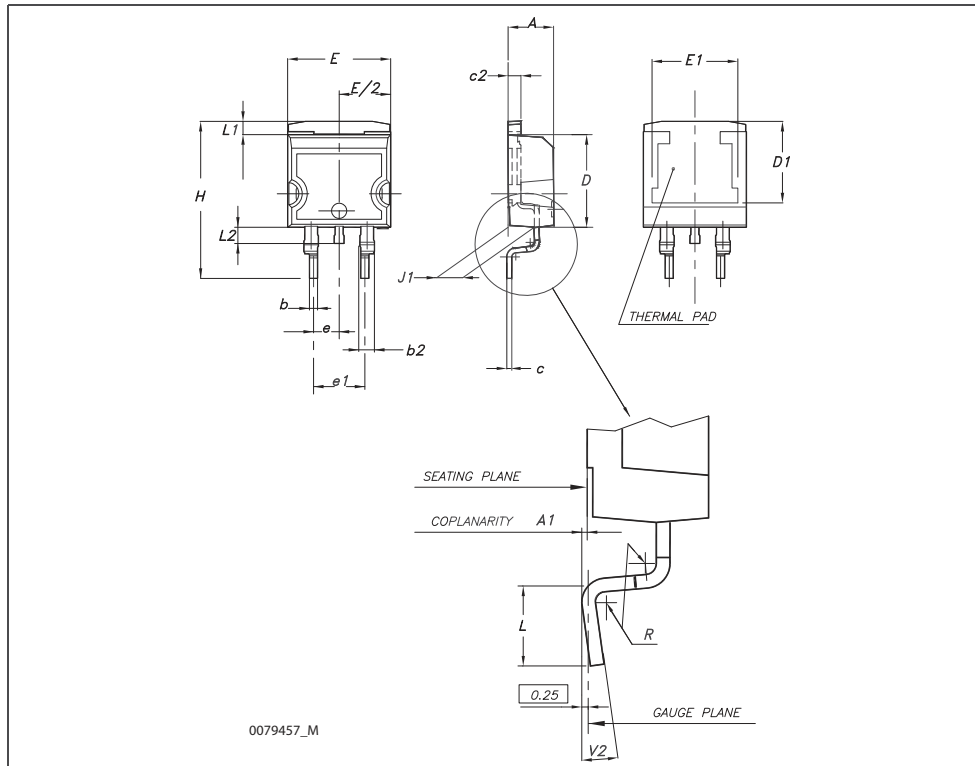

TO-220 mechanical data

Dim	mm			inch		
	Min	Typ	Max	Min	Typ	Max
A	4.40		4.60	0.173		0.181
b	0.61		0.88	0.024		0.034
b1	1.14		1.70	0.044		0.066
c	0.48		0.70	0.019		0.027
D	15.25		15.75	0.6		0.62
D1		1.27			0.050	
E	10		10.40	0.393		0.409
e	2.40		2.70	0.094		0.106
e1	4.95		5.15	0.194		0.202
F	1.23		1.32	0.048		0.051
H1	6.20		6.60	0.244		0.256
J1	2.40		2.72	0.094		0.107
L	13		14	0.511		0.551
L1	3.50		3.93	0.137		0.154
L20		16.40			0.645	
L30		28.90			1.137	
∅P	3.75		3.85	0.147		0.151
Q	2.65		2.95	0.104		0.116

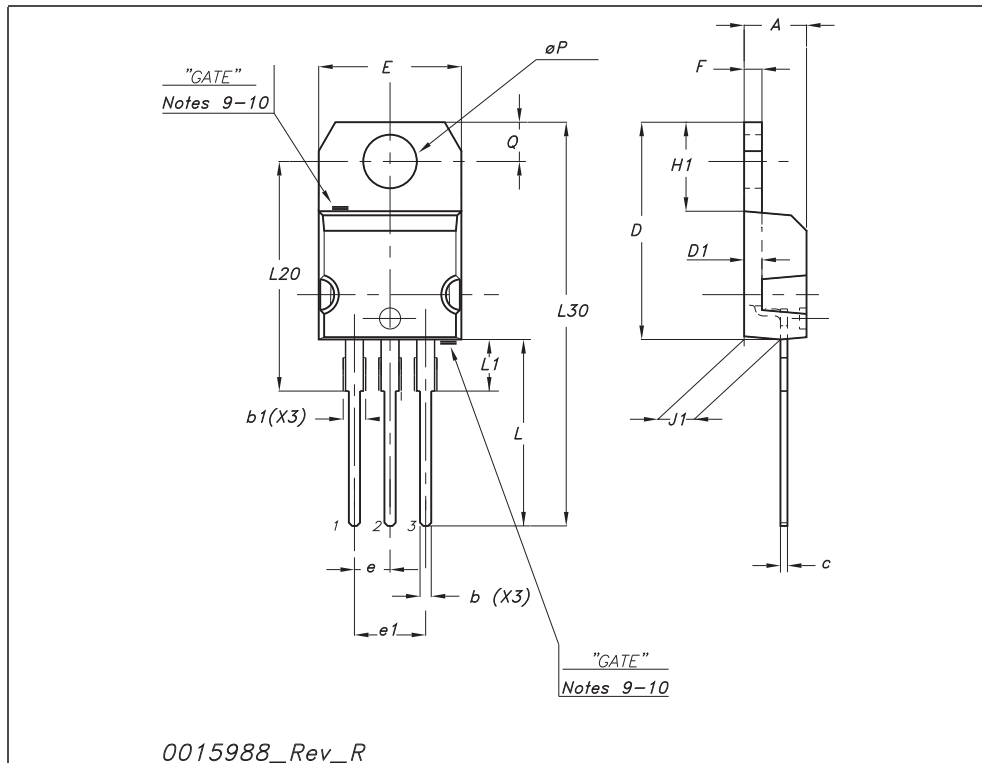

**TO-247 Mechanical data**

Dim.	mm.		
	Min.	Typ	Max.
A	4.85		5.15
A1	2.20		2.60
b	1.0		1.40
b1	2.0		2.40
b2	3.0		3.40
c	0.40		0.80
D	19.85		20.15
E	15.45		15.75
e		5.45	
L	14.20		14.80
L1	3.70		4.30
L2		18.50	
øP	3.55		3.65
øR	4.50		5.50
S		5.50	

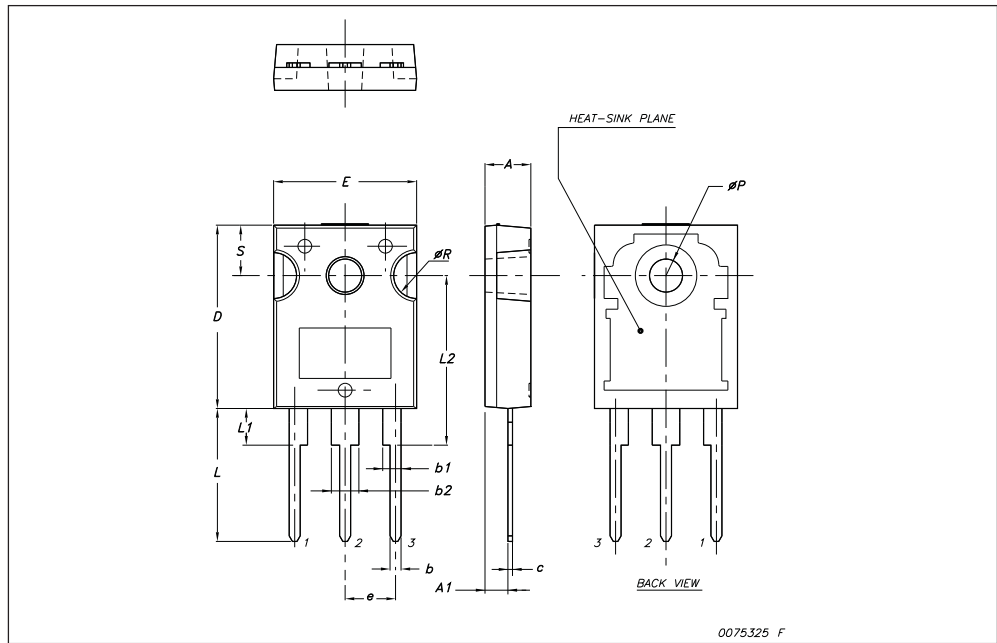

## 5 Packaging mechanical data

D<sup>2</sup>PAK FOOTPRINT

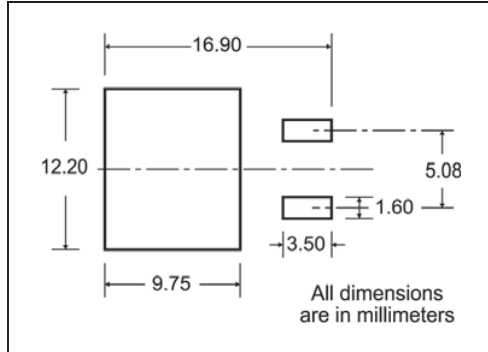

TAPE AND REEL SHIPMENT

40 mm min. Access hole at slot location

Full radius

Tape slot in core for tape start 2.5mm min. width

2.5mm min. width

REEL MECHANICAL DATA

DIM.	mm		inch	
	MIN.	MAX.	MIN.	MAX.
A		330		12.992
B	1.5		0.059	
C	12.8	13.2	0.504	0.520
D	20.2		0.795	
G	24.4	26.4	0.960	1.039
N	100		3.937	
T		30.4		1.197

BASE QTY	BULK QTY
1000	1000

TAPE MECHANICAL DATA

DIM.	mm		inch	
	MIN.	MAX.	MIN.	MAX.
A0	10.5	10.7	0.413	0.421
B0	15.7	15.9	0.618	0.626
D	1.5	1.6	0.059	0.063
D1	1.59	1.61	0.062	0.063
E	1.65	1.85	0.065	0.073
F	11.4	11.6	0.449	0.456
K0	4.8	5.0	0.189	0.197
P0	3.9	4.1	0.153	0.161
P1	11.9	12.1	0.468	0.476
P2	1.9	2.1	0.075	0.082
R	50		1.574	
T	0.25	0.35	0.0098	0.0137
W	23.7	24.3	0.933	0.956

10 pitches cumulative tolerance on tape +/- 0.2 mm

TOP COVER TAPE

User Direction of Feed

TRL

FEED DIRECTION

Bending radius R min.

## 6 Revision history

**Table 8. Document revision history**

Date	Revision	Changes
04-Oct-2006	1	Initial release.
08-May-2007	2	Modified value on <a href="#">Table 2</a>
20-Nov-2008	3	Inserted packages: D <sup>2</sup> PAK and TO-247

**Please Read Carefully:**

Information in this document is provided solely in connection with ST products. STMicroelectronics NV and its subsidiaries ("ST") reserve the right to make changes, corrections, modifications or improvements, to this document, and the products and services described herein at any time, without notice.

All ST products are sold pursuant to ST's terms and conditions of sale.

Purchasers are solely responsible for the choice, selection and use of the ST products and services described herein, and ST assumes no liability whatsoever relating to the choice, selection or use of the ST products and services described herein.

No license, express or implied, by estoppel or otherwise, to any intellectual property rights is granted under this document. If any part of this document refers to any third party products or services it shall not be deemed a license grant by ST for the use of such third party products or services, or any intellectual property contained therein or considered as a warranty covering the use in any manner whatsoever of such third party products or services or any intellectual property contained therein.

**UNLESS OTHERWISE SET FORTH IN ST'S TERMS AND CONDITIONS OF SALE ST DISCLAIMS ANY EXPRESS OR IMPLIED WARRANTY WITH RESPECT TO THE USE AND/OR SALE OF ST PRODUCTS INCLUDING WITHOUT LIMITATION IMPLIED WARRANTIES OF MERCHANTABILITY, FITNESS FOR A PARTICULAR PURPOSE (AND THEIR EQUIVALENTS UNDER THE LAWS OF ANY JURISDICTION), OR INFRINGEMENT OF ANY PATENT, COPYRIGHT OR OTHER INTELLECTUAL PROPERTY RIGHT.**

**UNLESS EXPRESSLY APPROVED IN WRITING BY AN AUTHORIZED ST REPRESENTATIVE, ST PRODUCTS ARE NOT RECOMMENDED, AUTHORIZED OR WARRANTED FOR USE IN MILITARY, AIR CRAFT, SPACE, LIFE SAVING, OR LIFE SUSTAINING APPLICATIONS, NOR IN PRODUCTS OR SYSTEMS WHERE FAILURE OR MALFUNCTION MAY RESULT IN PERSONAL INJURY, DEATH, OR SEVERE PROPERTY OR ENVIRONMENTAL DAMAGE. ST PRODUCTS WHICH ARE NOT SPECIFIED AS "AUTOMOTIVE GRADE" MAY ONLY BE USED IN AUTOMOTIVE APPLICATIONS AT USER'S OWN RISK.**

Resale of ST products with provisions different from the statements and/or technical features set forth in this document shall immediately void any warranty granted by ST for the ST product or service described herein and shall not create or extend in any manner whatsoever, any liability of ST.

ST and the ST logo are trademarks or registered trademarks of ST in various countries.

Information in this document supersedes and replaces all information previously supplied.

The ST logo is a registered trademark of STMicroelectronics. All other names are the property of their respective owners.

© 2008 STMicroelectronics - All rights reserved

STMicroelectronics group of companies

Australia - Belgium - Brazil - Canada - China - Czech Republic - Finland - France - Germany - Hong Kong - India - Israel - Italy - Japan - Malaysia - Malta - Morocco - Singapore - Spain - Sweden - Switzerland - United Kingdom - United States of America

[www.st.com](http://www.st.com)