



UM30-212111

UM30

ULTRASONIC SENSORS

SICK
Sensor Intelligence.



Ordering information

Type	Part no.
UM30-212111	6037661

Other models and accessories → www.sick.com/UM30



Detailed technical data

Mechanics/electronics

Supply voltage V_s	DC 9 V ... 30 V ¹⁾
Power consumption	$\leq 2.4 \text{ W}$ ²⁾
Initialization time	< 300 ms
Design	Cylindrical
Housing material	Metal (nickel-plated brass, PBT) Ultrasonic transducer: polyurethane foam, glass epoxy resin
Thread size	M30 x 1.5
Connection type	Male connector, M12, 5-pin
Indication	LED display, 2 x LED
Weight	150 g
Sending axis	Straight
Dimensions (W x H x D)	30 mm x 30 mm x 84 mm
Enclosure rating	IP65 / IP67
Protection class	III

¹⁾ Limit values, reverse-polarity protected Operation in short-circuit protected network: max. 8 A, class 2.

²⁾ Without load.

Performance

Operating range, limiting range	65 mm ... 350 mm, 600 mm
Target	Natural objects
Resolution	$\geq 0.18 \text{ mm}$
Repeatability	$\pm 0.15 \%$ ¹⁾
Accuracy	$\pm 1 \%$ ^{2) 3)}
Temperature compensation	✓

¹⁾ In relation to the current measured value, minimum value \geq resolution.

²⁾ Referring to current measurement value.

³⁾ Temperature compensation can be switched off, without temperature compensation: 0.17 % / K.

Response time	64 ms
Switching frequency	12 Hz
Output time	16 ms
Ultrasonic frequency (typical)	400 kHz
Detection area (typical)	See diagrams
Additional function	Adjustable operating modes: Switching point (Dt0) / Switching window/Background (ObSB), teach-in of digital output, set levels of digital outputs, invertable digital output, set on delay digital output, synchronization of up to 50 sensors, multiplexing: no cross talk of up to 50 sensors, adjustable measurement filters: Measured value filters/Filter strength/Foreground suppression/Detection area/Sensitivity and sound beam, Display (can be deactivated), reset to factory default

- 1) In relation to the current measured value, minimum value \geq resolution.
 2) Referring to current measurement value.
 3) Temperature compensation can be switched off, without temperature compensation: 0.17 % / K.

Interfaces

Digital output		
	Number	1 ¹⁾
	Type	PNP
	Maximum output current I_A	≤ 200 mA
Multifunctional input (MF)		1 x MF
Hysteresis		5 mm

1) PNP: HIGH = $V_S - (< 2 \text{ V})$ / LOW = 0 V.

Ambient data

Ambient temperature, operation	-25 °C ... +70 °C
Ambient temperature, storage	-40 °C ... +85 °C

Classifications

ECl@ss 5.0	27270804
ECl@ss 5.1.4	27270804
ECl@ss 6.0	27270804
ECl@ss 6.2	27270804
ECl@ss 7.0	27270804
ECl@ss 8.0	27270804
ECl@ss 8.1	27270804
ECl@ss 9.0	27270804
ECl@ss 10.0	27270804
ECl@ss 11.0	27270804
ETIM 5.0	EC001846
ETIM 6.0	EC001846
ETIM 7.0	EC001846
UNSPSC 16.0901	41111960

Dimensional drawing (Dimensions in mm (inch))

UM30-211, UM30-212, UM30-213

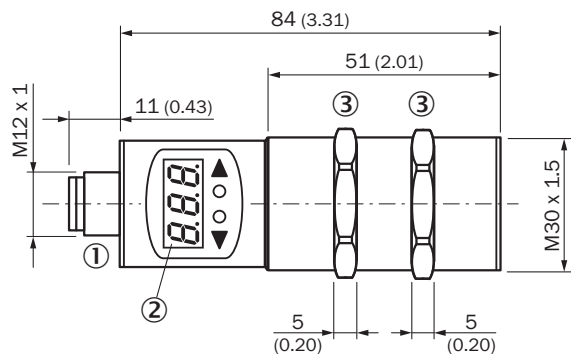

- ① Connection
- ② Display
- ③ Mounting nuts, SW 36 mm

Connection type

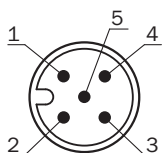

Connection diagram

UM30-21x111 UM30-21x114 Connector M12, 5-pin

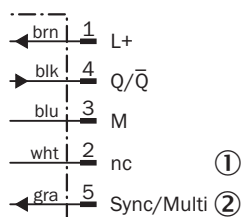

- ① Not assigned
- ② Synchronization and multiplex operation/communication Connect+

Adjustment possible

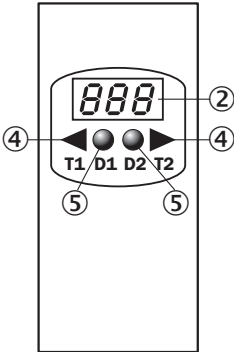

- ② Display
- ④ Control elements
- ⑤ Status indicators

Detection area

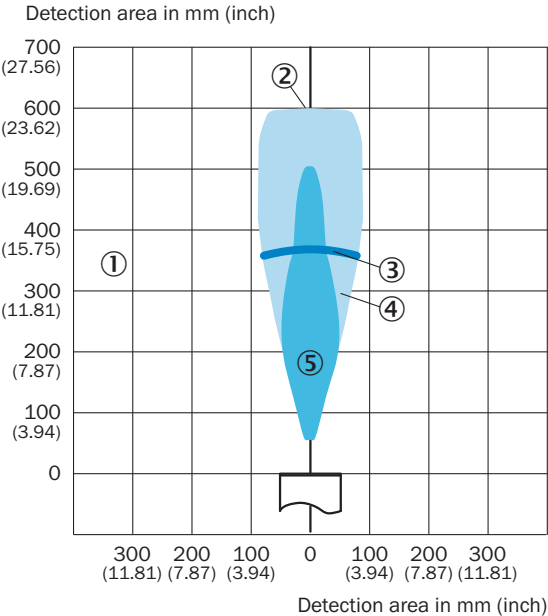

UM30-212



- ① Detection range dependent on reflection properties, size, and alignment of the object
- ② Limiting range
- ③ Operating range
- ④ Example object: aligned plate 500 mm x 500 mm
- ⑤ Example object: pipe with 27 mm diameter

Recommended accessories

Other models and accessories → www.sick.com/UM30

	Brief description	Type	Part no.
Mounting brackets and plates			
	Mounting bracket for M30 sensors, steel, zinc coated, without mounting hardware	BEF-WN-M30	5308445
Programming and configuration tools			
	Tool for visualization, configuration and cloning, 3-digit LED display, supply voltage: DV 9 V ... 30 V	Connect+ adapter (CPA)	6037782
Plug connectors and cables			
	Head A: female connector, M12, 5-pin, straight, A-coded Head B: Flying leads Cable: Sensor/actuator cable, PVC, unshielded, 2 m	YF2A15-020VB5XLEAX	2096239

Recommended services

Additional services → www.sick.com/UM30

	Type	Part no.
Warranty extensions		
<ul style="list-style-type: none"> • Product area: Identification solutions, machine vision, Distance sensors, Detection and ranging solutions • Range of services: The services correspond to the scope of the statutory manufacturer warranty (SICK general terms and conditions of purchase) • Duration: Five-year warranty from delivery date. 	Extended warranty for a total of five years from delivery date	1680671

SICK AT A GLANCE

SICK is one of the leading manufacturers of intelligent sensors and sensor solutions for industrial applications. A unique range of products and services creates the perfect basis for controlling processes securely and efficiently, protecting individuals from accidents and preventing damage to the environment.

We have extensive experience in a wide range of industries and understand their processes and requirements. With intelligent sensors, we can deliver exactly what our customers need. In application centers in Europe, Asia and North America, system solutions are tested and optimized in accordance with customer specifications. All this makes us a reliable supplier and development partner.

Comprehensive services complete our offering: SICK LifeTime Services provide support throughout the machine life cycle and ensure safety and productivity.

For us, that is “Sensor Intelligence.”

WORLDWIDE PRESENCE:

Contacts and other locations –www.sick.com