

1N4148
SILICON SWITCHING DIODE

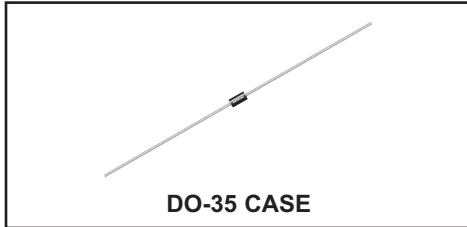

www.centrasemi.com

DESCRIPTION:

The CENTRAL SEMICONDUCTOR 1N4148 is a high speed switching diode manufactured in a DO-35 hermetically sealed glass case. The 1N4148 is a drop in replacement for the 1N914.

MARKING: C4148 or FULL PART NUMBER

MAXIMUM RATINGS: ($T_A=25^{\circ}\text{C}$)

| | SYMBOL | | UNITS |
|--|----------------|-------------|--------------------|
| Peak Repetitive Reverse Voltage | V_{RRM} | 100 | V |
| Peak Working Reverse Voltage | V_{RWM} | 75 | V |
| Average Forward Current | I_O | 150 | mA |
| DC Forward Current | I_F | 200 | mA |
| Peak Forward Surge Current, $t_p=1.0\mu\text{s}$ | I_{FSM} | 2.0 | A |
| Power Dissipation | P_D | 500 | mW |
| Operating and Storage Junction Temperature | T_J, T_{stg} | -65 to +200 | $^{\circ}\text{C}$ |

ELECTRICAL CHARACTERISTICS: ($T_A=25^{\circ}\text{C}$ unless otherwise noted)

| SYMBOL | TEST CONDITIONS | MIN | MAX | UNITS |
|---------------|--|------------|------------|--------------|
| I_R | $V_R=20\text{V}$ | | 25 | nA |
| BV_R | $I_R=1.0\text{mA}$ | 100 | | V |
| BV_R | $I_R=100\mu\text{A}$ | 75 | | V |
| V_F | $I_F=10\text{mA}$ | | 1.0 | V |
| C_J | $V_R=0, f=1.0\text{MHz}$ | | 4.0 | pF |
| t_{rr} | $V_R=6.0\text{V}, I_F=10\text{mA}, I_{rr}=1.0\text{mA}, R_L=100\Omega$ | | 4.0 | ns |

1N4148
SILICON SWITCHING DIODE



DO-35 CASE - MECHANICAL OUTLINE

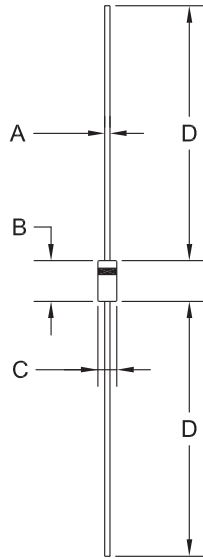

| DIMENSIONS | | | | |
|-------------------|--------|-------|-------------|------|
| SYMBOL | INCHES | | MILLIMETERS | |
| | MIN | MAX | MIN | MAX |
| A | 0.018 | 0.022 | 0.46 | 0.56 |
| B | 0.120 | 0.200 | 3.05 | 5.08 |
| C | 0.060 | 0.090 | 1.52 | 2.29 |
| D | 1.000 | - | 25.40 | - |

DO-35 (REV: R1)

R1

R2 (6-December 2019)

1N4148
SILICON SWITCHING DIODE



TYPICAL ELECTRICAL CHARACTERISTICS

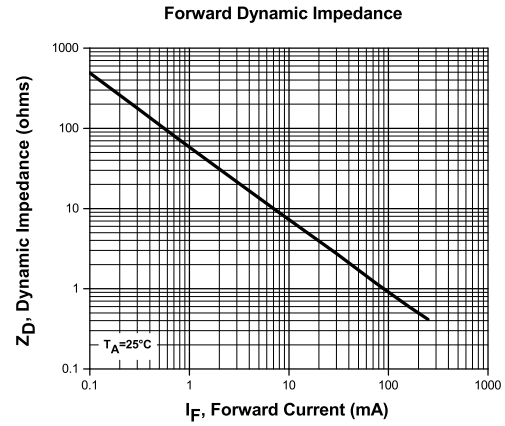
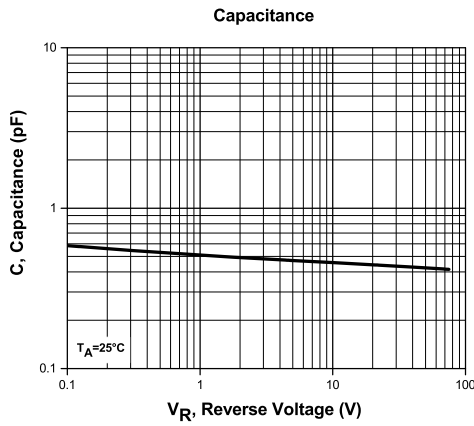
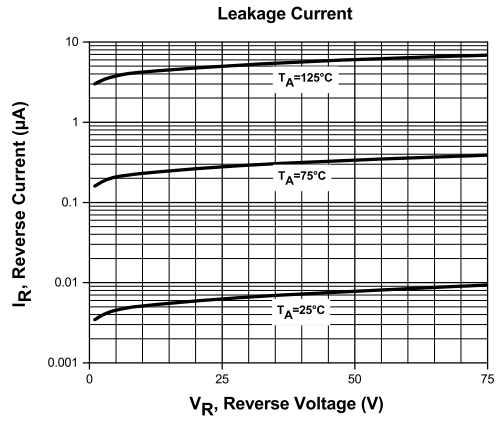
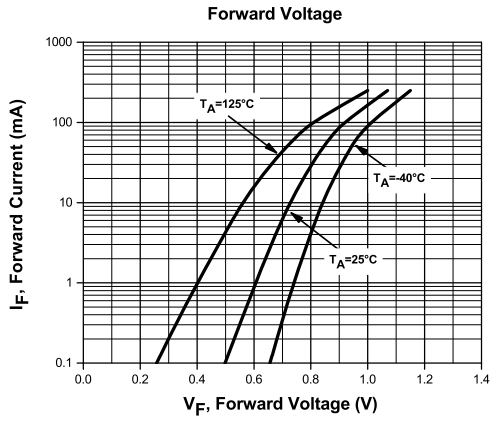

R2 (6-December 2019)

1N4148
SILICON SWITCHING DIODE



TYPICAL ELECTRICAL CHARACTERISTICS

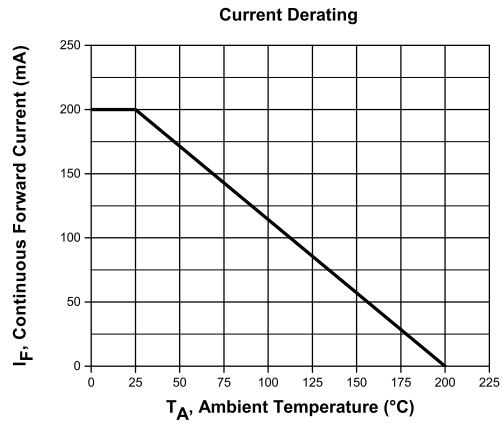
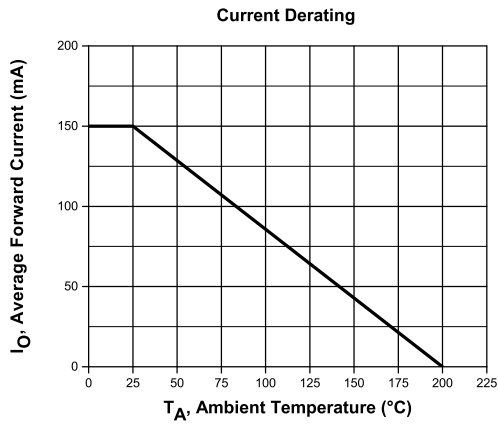
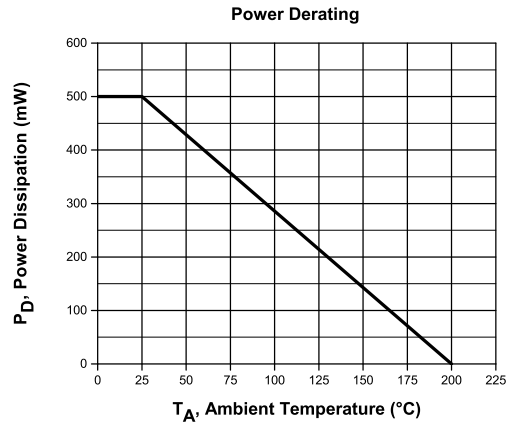
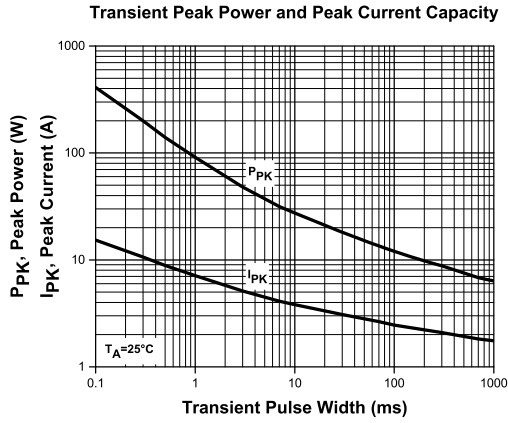

R2 (6-December 2019)

OUTSTANDING SUPPORT AND SUPERIOR SERVICES



PRODUCT SUPPORT

Central's operations team provides the highest level of support to insure product is delivered on-time.

- Supply management (Customer portals)
- Inventory bonding
- Consolidated shipping options
- Custom bar coding for shipments
- Custom product packing

DESIGNER SUPPORT/SERVICES

Central's applications engineering team is ready to discuss your design challenges. Just ask.

- Free quick ship samples (2nd day air)
- Online technical data and parametric search
- SPICE models
- Custom electrical curves
- Environmental regulation compliance
- Customer specific screening
- Up-screening capabilities
- Special wafer diffusions
- PbSn plating options
- Package details
- Application notes
- Application and design sample kits
- Custom product and package development

REQUESTING PRODUCT PLATING

1. If requesting Tin/Lead plated devices, add the suffix "TIN/LEAD" to the part number when ordering (example: 2N2222A TIN/LEAD).
2. If requesting Lead (Pb) Free plated devices, add the suffix "PBFREE" to the part number when ordering (example: 2N2222A PBFREE).

CONTACT US

Corporate Headquarters & Customer Support Team

Central Semiconductor Corp.
145 Adams Avenue
Hauppauge, NY 11788 USA
Main Tel: (631) 435-1110
Main Fax: (631) 435-1824
Support Team Fax: (631) 435-3388
www.centrasemi.com

Worldwide Field Representatives:
www.centrasemi.com/wwreps

Worldwide Distributors:
www.centrasemi.com/wwdistributors

For the latest version of Central Semiconductor's **LIMITATIONS AND DAMAGES DISCLAIMER**, which is part of Central's Standard Terms and Conditions of sale, visit: www.centrasemi.com/terms



<http://www.centrasemi.com>

Product End of Life Notification

| | |
|---------------------------|----------|
| PDN ID: | PDN01011 |
| Notification Date: | 12/14/15 |
| Last Buy Date: | 6/14/16 |
| Last Shipment Date | 12/14/16 |

Summary: The 1N914 silicon switching diode is discontinued and now classified as End of Life (EOL).

Although Central Semiconductor Corp. makes every effort to continue to produce devices that have been proclaimed EOL (End of Life) by various manufacturers, it is an accepted industry practice to discontinue certain devices when customer demand falls below a minimum level of sustainability. Accordingly, the following product(s) have been transitioned to End of Life status as part of Central's Product Management Process. Any replacement product will be noted below. The effective date for placing the last purchase order will be six(6) months from the date of this notice and twelve(12) months from the notice date for final shipments; this may be extended if inventory is available.

| <u>Central Part Number</u> | <u>Replacement</u> |
|----------------------------|--------------------|
| 1N914 BK | 1N4148 BK |
| 1N914 TR | 1N4148 TR |

Central would be happy to assist you by providing additional information or technical data to help locate an alternate source if we have no replacement available. Please email your requests to engineering@centrasemi.com.

DISCLAIMER: This End of Life (EOL) notification is in accordance with JEDEC standard JESD48 - Product Discontinuance. Central Semiconductor Corp. will make every effort to offer life-time buy (LTB) opportunities and/or offer replacement devices to existing customers for discontinued devices, however, one or both may not be possible for all devices. Please contact your local Central Semiconductor sales representative for LTB opportunities/additional information.



<http://www.centrasemi.com>

Product End of Life Notification

| | |
|---------------------------|----------|
| PDN ID: | PDN01025 |
| Notification Date: | 5/18/16 |
| Last Buy Date: | 11/18/16 |
| Last Shipment Date | 5/18/17 |

Summary: The 1N4148 silicon switching diode in the DO-35 case is discontinued and now classified as End of Life (EOL). Central has a variety of equivalent devices in surface mount packages that can be used as replacements for the through-hole 1N4148. Please contact your sales representative for assistance.

Although Central Semiconductor Corp. makes every effort to continue to produce devices that have been proclaimed EOL (End of Life) by various manufacturers, it is an accepted industry practice to discontinue certain devices when customer demand falls below a minimum level of sustainability. Accordingly, the following product(s) have been transitioned to End of Life status as part of Central's Product Management Process. Any replacement product will be noted below. The effective date for placing the last purchase order will be six(6) months from the date of this notice and twelve(12) months from the notice date for final shipments; this may be extended if inventory is available.

| <u>Central Part Number</u> | <u>Replacement</u> |
|----------------------------|--------------------|
| 1N4148 BK | N/A |
| 1N4148 TR | N/A |

Central would be happy to assist you by providing additional information or technical data to help locate an alternate source if we have no replacement available. Please email your requests to engineering@centrasemi.com.

DISCLAIMER: This End of Life (EOL) notification is in accordance with JEDEC standard JESD48 - Product Discontinuance. Central Semiconductor Corp. will make every effort to offer life-time buy (LTB) opportunities and/or offer replacement devices to existing customers for discontinued devices, however, one or both may not be possible for all devices. Please contact your local Central Semiconductor sales representative for LTB opportunities/additional information.