

■ Features

- $V_{DS} (V) = -30V$
- $I_D = -2.6 A (V_{GS} = -10V)$
- $R_{DS(ON)} < 130m\ \Omega (V_{GS} = -10V)$
- $R_{DS(ON)} < 200m\ \Omega (V_{GS} = -4.5V)$
- Pb-Free Package May be Available. The G-Suffix Denotes a Pb-Free Lead Finish

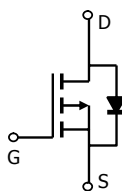
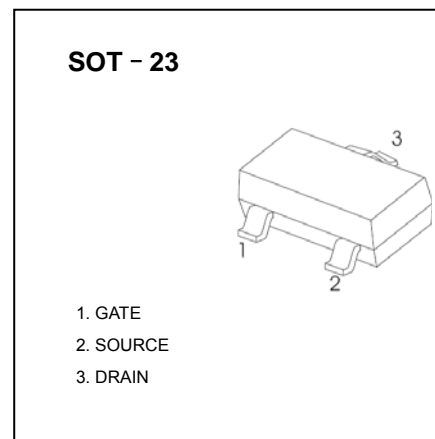

■ Absolute Maximum Ratings  $T_a = 25^\circ C$

Parameter	Symbol	Rating	Unit
Drain-Source Voltage	$V_{DS}$	-30	V
Gate-Source Voltage	$V_{GS}$	$\pm 20$	V
Continuous Drain Current	$I_D$	$T_A=25^\circ C$	A
		$T_A=70^\circ C$	
Pulsed Drain Current	$I_{DM}$	-20	
Power Dissipation	$P_D$	$T_A=25^\circ C$	W
		$T_A=70^\circ C$	
Thermal Resistance. Junction-to-Ambient	$R_{thJA}$	125	$^\circ C/W$
Thermal Resistance. Junction-to-Case	$R_{thJC}$	80	$^\circ C/W$
Junction and Storage Temperature Range	$T_J, T_{STG}$	-55 to 150	$^\circ C$

■ Electrical Characteristics Ta = 25°C

Parameter	Symbol	Testconditions	Min	Typ	Max	Unit
Drain-Source Breakdown Voltage	V <sub>DSS</sub>	I <sub>D</sub> =250 μ A, V <sub>GS</sub> =0V	-30			V
Zero Gate Voltage Drain Current	I <sub>DSS</sub>	V <sub>DS</sub> =-24V, V <sub>GS</sub> =0V			-1	μ A
		V <sub>DS</sub> =-24V, V <sub>GS</sub> =0V, T <sub>J</sub> =55°C			-5	
Gate-Body leakage current	I <sub>GSS</sub>	V <sub>DS</sub> =0V, V <sub>GS</sub> = ± 20V			± 100	nA
Gate Threshold Voltage	V <sub>GS(th)</sub>	V <sub>DS</sub> =V <sub>GS</sub> I <sub>D</sub> =-250 μ A	-1	-1.9	-3	V
Static Drain-Source On-Resistance	r <sub>DS(ON)</sub>	V <sub>GS</sub> =-10V, I <sub>D</sub> =-2.6A		97	130	mΩ
		V <sub>GS</sub> =-10V, I <sub>D</sub> =-2.6A T <sub>J</sub> =125°C		135	150	
		V <sub>GS</sub> =-4.5V, I <sub>D</sub> =-2A		166	200	mΩ
On state drain current	I <sub>D(ON)</sub>	V <sub>GS</sub> =-4.5V, V <sub>DS</sub> =-5V	-5			A
Forward Transconductance	g <sub>fs</sub>	V <sub>DS</sub> =-5V, I <sub>D</sub> =-5A	3	3.8		S
Input Capacitance	C <sub>iss</sub>	V <sub>GS</sub> =0V, V <sub>DS</sub> =-15V, f=1MHz		302	370	pF
Output Capacitance	C <sub>oss</sub>			50.3		pF
Reverse Transfer Capacitance	C <sub>rss</sub>			37.8		pF
Gate resistance	R <sub>g</sub>	V <sub>GS</sub> =0V, V <sub>DS</sub> =0V, f=1MHz		12	18	Ω
Total Gate Charge (10V)	Q <sub>g</sub>	V <sub>GS</sub> =-4.5V, V <sub>DS</sub> =-15V, I <sub>D</sub> =-2.6A		6.8	9	nC
Total Gate Charge (4.5V)				2.4		nC
Gate Source Charge	Q <sub>gs</sub>			1.6		nC
Gate Drain Charge	Q <sub>gd</sub>			0.95		nC
Turn-On DelayTime	t <sub>D(on)</sub>		V <sub>GS</sub> =-10V, V <sub>DS</sub> =-15V, R <sub>L</sub> =5.8 Ω, R <sub>GEN</sub> =3 Ω		7.5	
Turn-On Rise Time	t <sub>r</sub>			3.2		ns
Turn-Off DelayTime	t <sub>D(off)</sub>			17		ns
Turn-Off Fall Time	t <sub>f</sub>			6.8		ns
Body Diode Reverse Recovery Time	t <sub>rr</sub>	I <sub>F</sub> =-2.6A, dI/dt=100A/ μ s		16.8	22	ns
Body Diode Reverse Recovery Charge	Q <sub>rr</sub>	I <sub>F</sub> =-2.6A, dI/dt=100A/ μ s		10		nC
Maximum Body-Diode Continuous Current	I <sub>S</sub>				-2	A
Diode Forward Voltage	V <sub>SD</sub>	I <sub>S</sub> =-1A, V <sub>GS</sub> =0V		-0.82	-1	V

\* Repetitive rating, pulse width limited by junction temperature.

■ Typical Characteristics

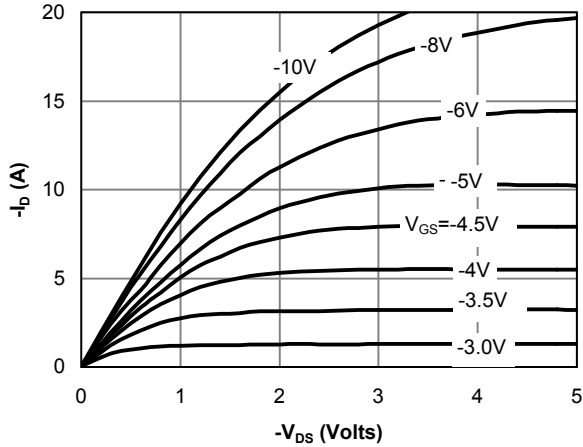

Fig 1: On-Region Characteristics

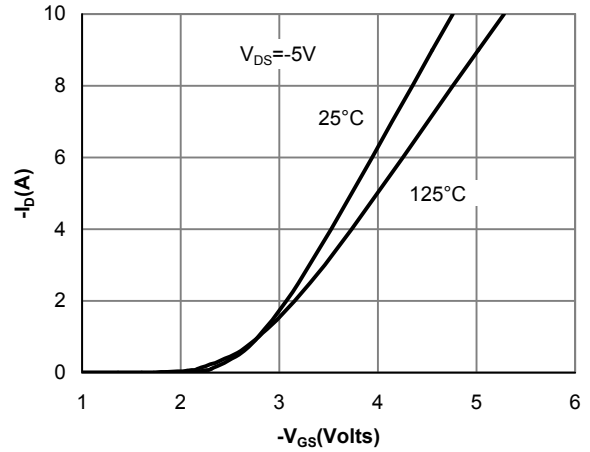

Figure 2: Transfer Characteristics

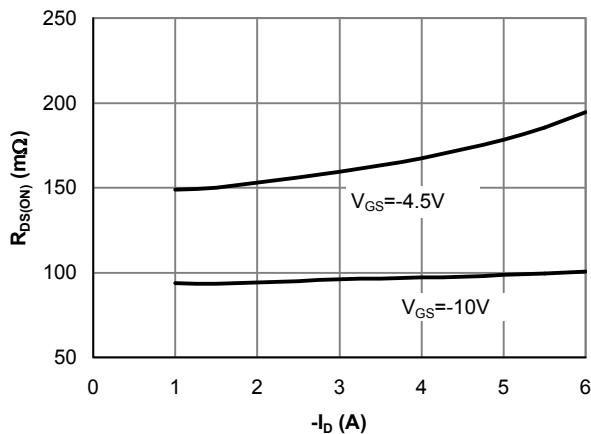

Figure 3: On-Resistance vs. Drain Current and Gate Voltage

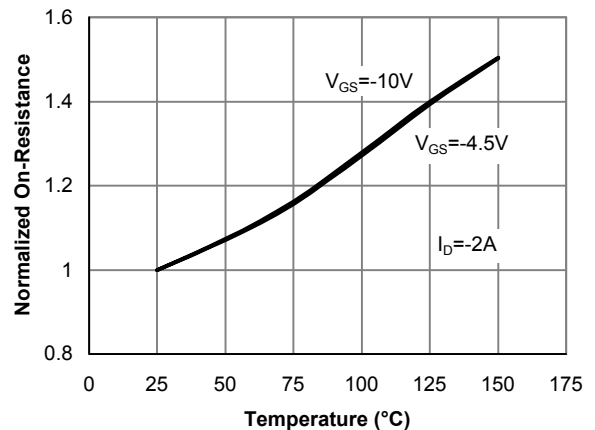

Figure 4: On-Resistance vs. Junction Temperature

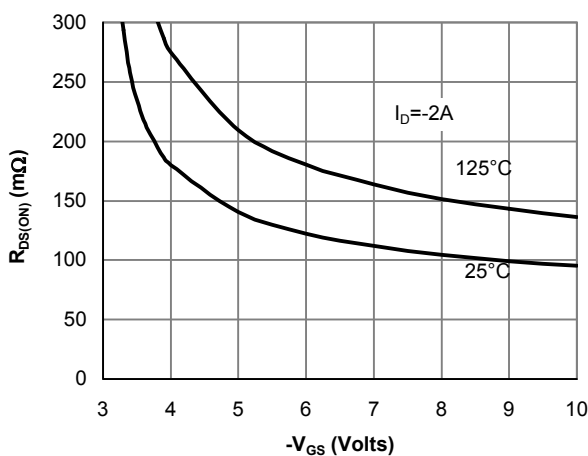

Figure 5: On-Resistance vs. Gate-Source Voltage

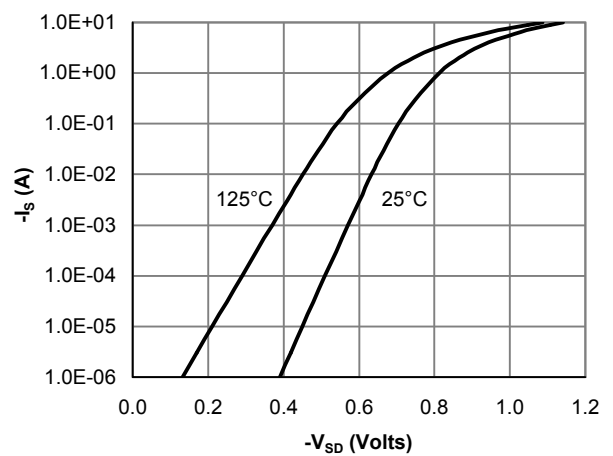

Figure 6: Body-Diode Characteristics

■ Typical Characteristics

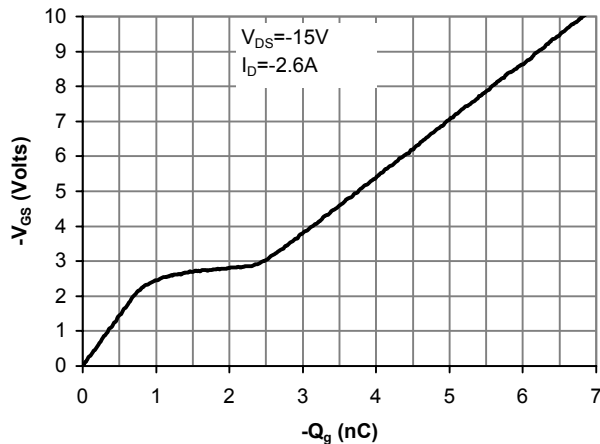

Figure 7: Gate-Charge Characteristics

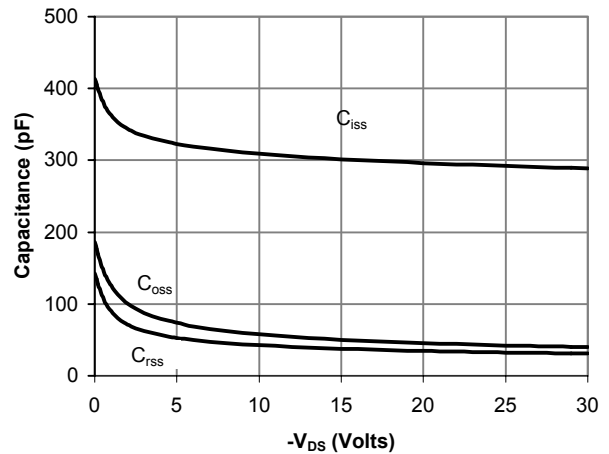

Figure 8: Capacitance Characteristics

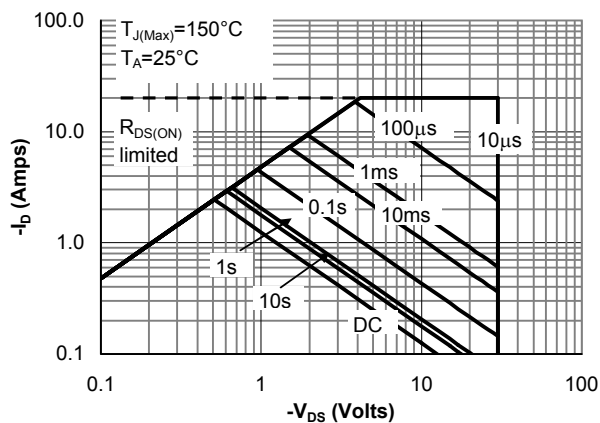

Figure 9: Maximum Forward Biased Safe Operating Area (Note E)

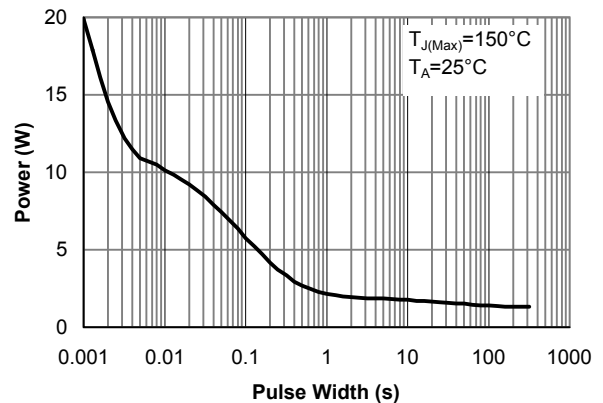

Figure 10: Single Pulse Power Rating Junction-to-Ambient (Note E)

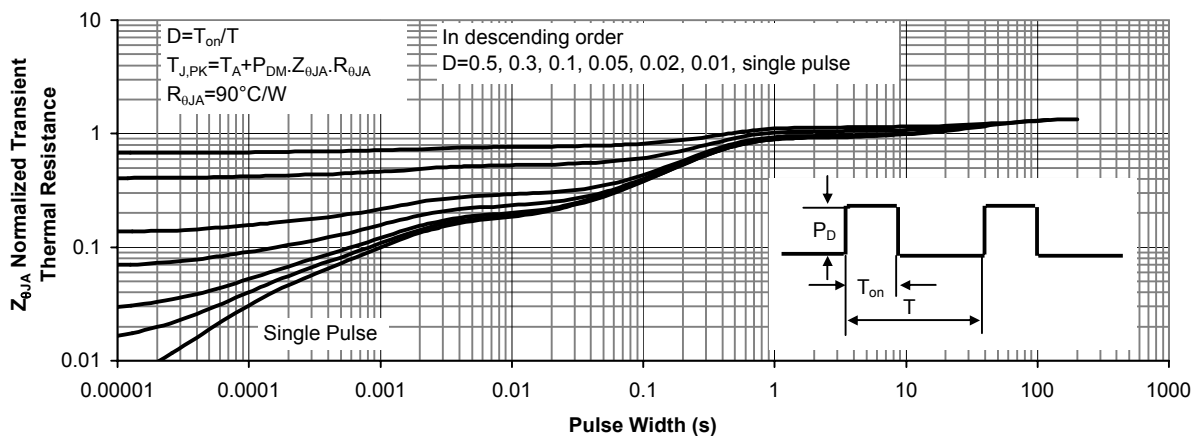
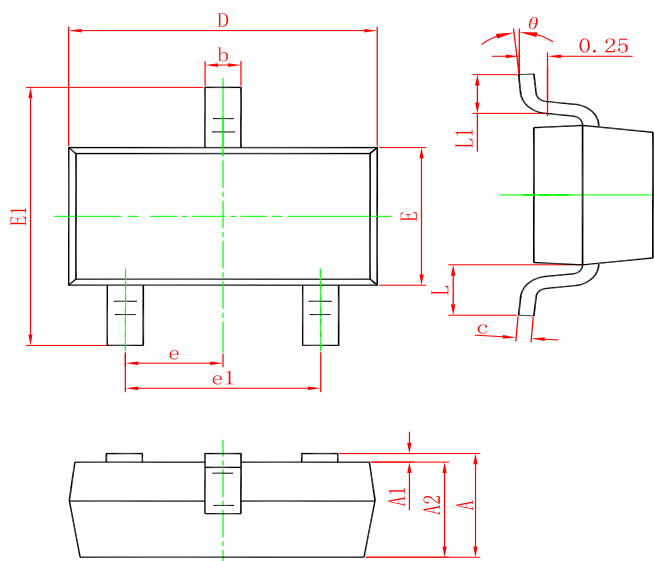

Figure 11: Normalized Maximum Transient Thermal Impedance

SOT-23 PACKAGE OUTLINE DIMENSIONS



Symbol	Dimensions In Millimeters		Dimensions In Inches	
	Min.	Max.	Min.	Max.
A	0.900	1.150	0.035	0.045
A1	0.000	0.100	0.000	0.004
A2	0.900	1.050	0.035	0.041
b	0.300	0.500	0.012	0.020
c	0.080	0.150	0.003	0.006
D	2.800	3.000	0.110	0.118
E	1.200	1.400	0.047	0.055
E1	2.250	2.550	0.089	0.100
e	0.950 TYP.		0.037 TYP.	
e1	1.800	2.000	0.071	0.079
L	0.550 REF.		0.022 REF.	
L1	0.300	0.500	0.012	0.020
θ	0°	8°	0°	8°

Marking

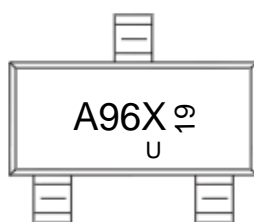

Ordering information

Order code	Package	Baseqty	Deliverymode
UMW AO3409A	SOT-23	3000	Tape and reel