

LOC		DIST		REVISIONS			
P	LTR	DESCRIPTION		DATE	DWN	APVD	
	B	ECR-18-009924		27JUN18	MG	BM	

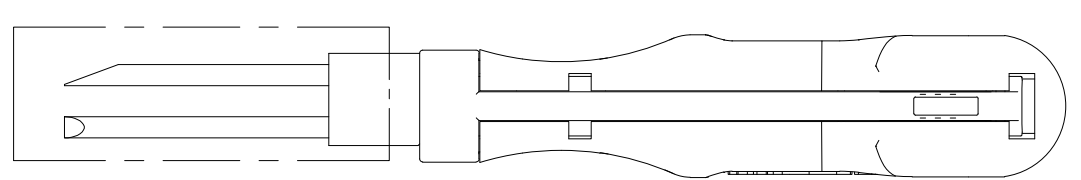

A

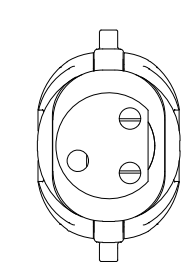
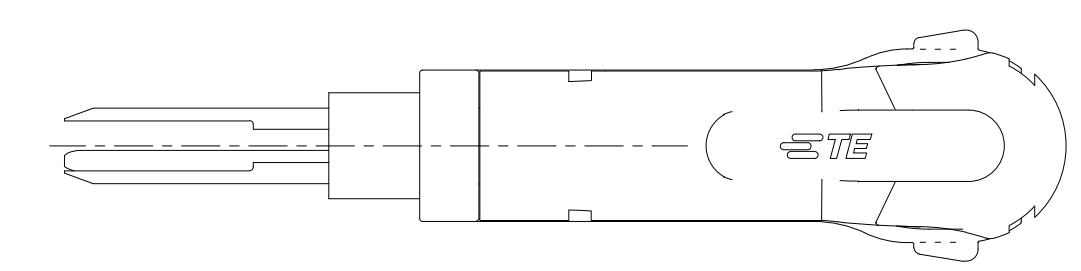
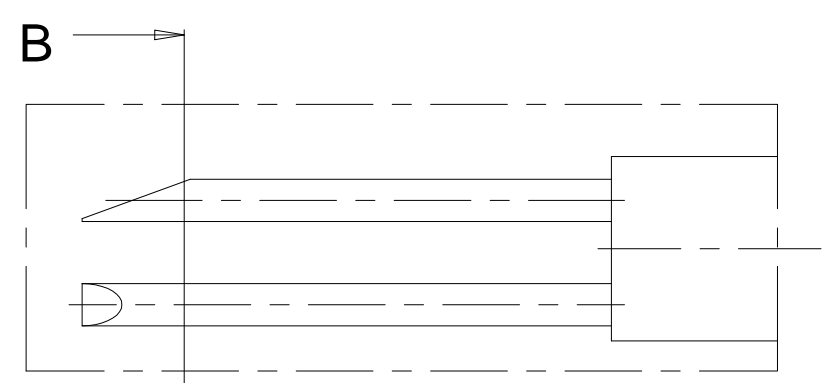

A
2:1

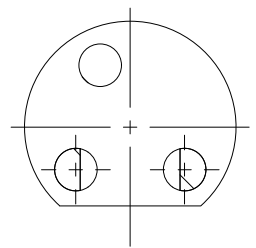

B-B

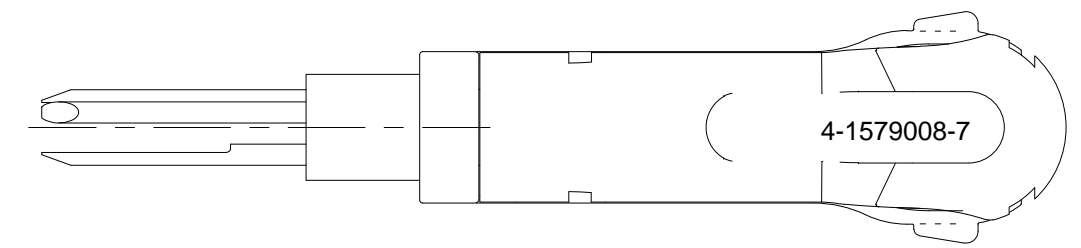

4-1579008-7

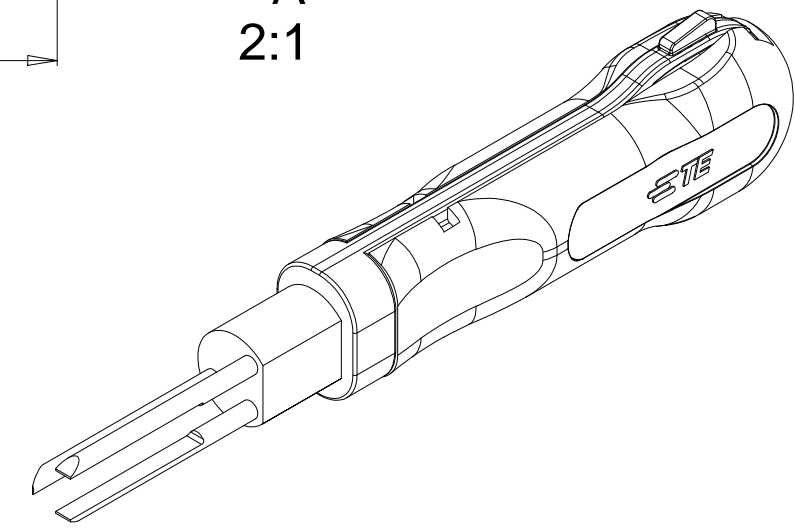

FOR CONTACTS / HOUSINGS:
 MPT (in relay holder)

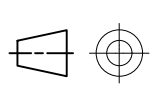
THIS DRAWING IS A CONTROLLED DOCUMENT.		DWN	06.11.2006		 TE Connectivity		
		CHK	m.pearson				
DIMENSIONS:		TOLERANCES UNLESS OTHERWISE SPECIFIED:		NAME			
mm				EXTRACTION TOOL			
		0 PLC ± -		PRODUCT SPEC			
		1 PLC ± -		APPLICATION SPEC			
		2 PLC ± -		SIZE			
		3 PLC ± -		CAGE CODE			
		4 PLC ± -		DRAWING NO			
		ANGLES ± -		RESTRICTED TO			
MATERIAL		FINISH		WEIGHT			
				0.061 kg			
CUSTOMER DRAWING				SCALE		SHEET	
				1:1		1 OF 1	
				REV		B	