

REF -50 OPTION SCREW
(WHERE APPLICABLE)

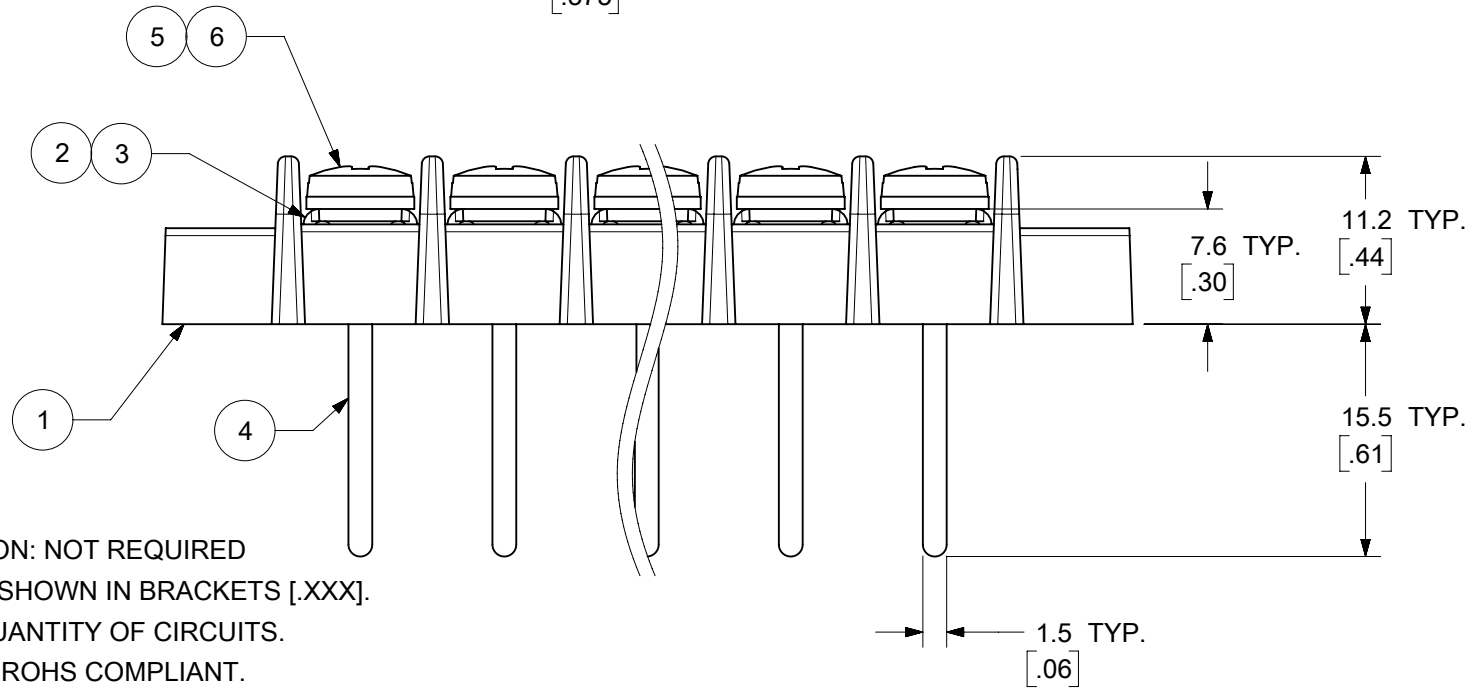

- NOTES:
1. MATERIAL: SEE TABLE
 2. FINISHES: SEE TABLE
 3. PRODUCT SPECIFICATION: NOT REQUIRED
 4. INCH DIMENSIONS ARE SHOWN IN BRACKETS [.XXX].
 5. "XX" REFERS TO THE QUANTITY OF CIRCUITS.
 6. ALL COMPONENTS ARE ROHS COMPLIANT.

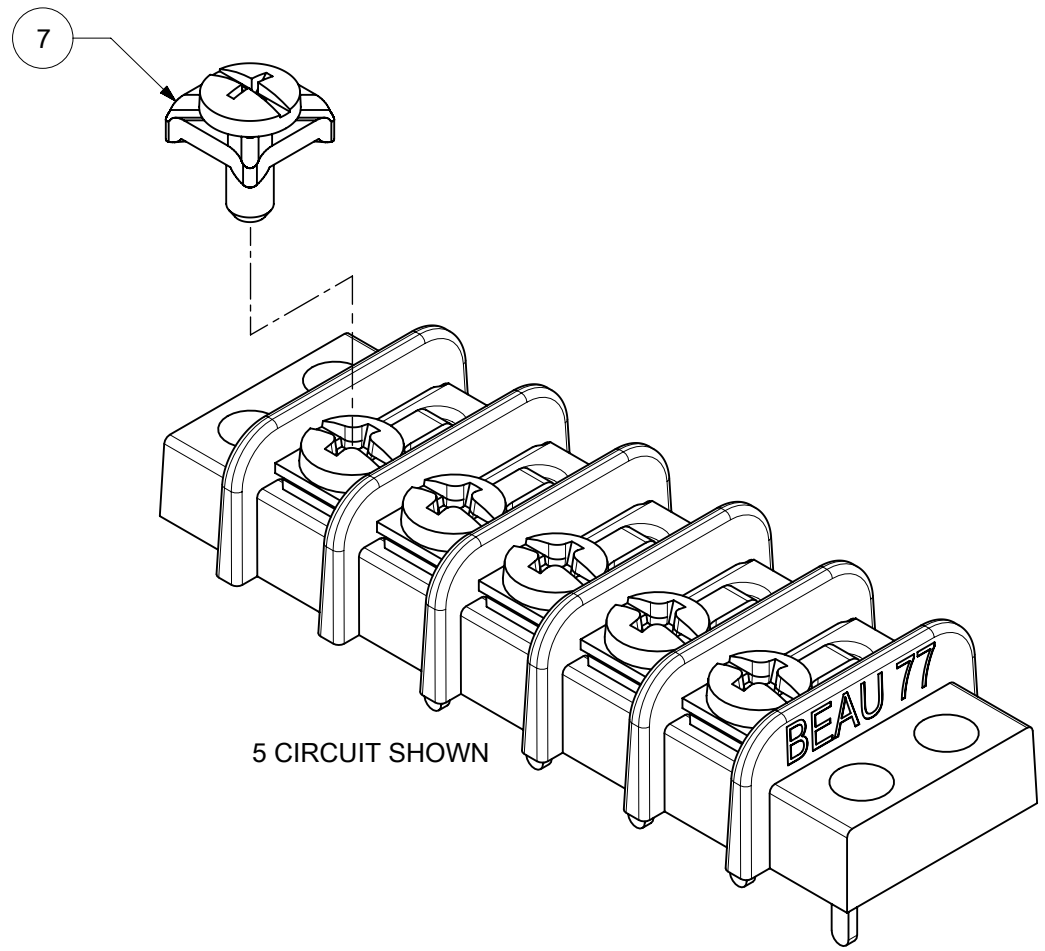
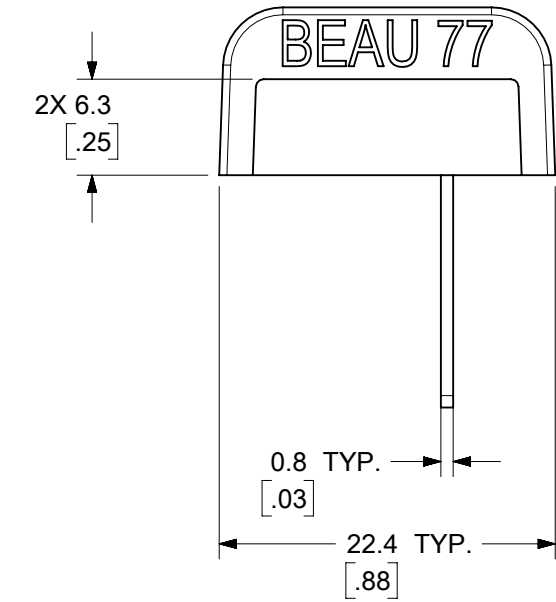

TOLERANCES			
MM	TOL	INCH	TOL
0-6	±0.25	0-.24	±.010
>6-30	±0.40	.24-1.18	±.016
>30-120	±0.50	1.18-4.76	±.020
>120	±0.80	>4.76	±.031

7	XX	SCREW, #6-32X.250 PAN HD, PHIL-SLOT W/WSHR (-50 OPTION)	STEEL	ZN, CLEAR CHROMATE
6	XX	SCREW, #6-32X.250 BGHD, PHIL-SLOT (-49 OPTION)	BRASS	NICKEL PLATE
5	XX	SCREW, #6-32X.250, BGHD PHIL-SLOT (STANDARD)	STEEL	ZN, CLEAR CHROMATE
4	XX	TERMINAL, WIRE TAP Y	BRASS	TIN PLATE
3	XX	TERMINAL PLATE (-49 OPTION)	BRASS	TIN PLATE
2	XX	TERMINAL PLATE	BRASS	NICKEL PLATE
1	1	INSULATOR	THERMOPLASTIC	BLACK
ITEM	QTY	DESCRIPTION	MATERIAL	FINISH

THIS DRAWING CONTAINS INFORMATION THAT IS PROPRIETARY TO MOLEX ELECTRONIC TECHNOLOGIES, LLC AND SHOULD NOT BE USED WITHOUT WRITTEN PERMISSION

FUNCTIONAL SYMBOLS: $\nabla_A = 0$, $\nabla_E = 0$, $\nabla_S = 0$

DIMENSION UNITS: MM/INCH

SCALE: 2:1

GENERAL TOLERANCES (UNLESS SPECIFIED):

	MM	INCH
4 PLACES	± .05	± .002
3 PLACES	± .06	± .0025
2 PLACES	± .07	± .003
1 PLACE	± .08	± .0035
0 PLACES	± .09	± .004

ANGULAR TOL: ± .5

DRAFT WHERE APPLICABLE MUST REMAIN WITHIN DIMENSIONS

THIRD ANGLE PROJECTION

DRAWING: B-SIZE

SERIES: 38770

EC NO: 642242

DRWN: ABENJAMINLW

CHK'D: MBRZOZOWSKI

APPR: JFMURPHY

INITIAL REVISION:

DRWN: AHIDALGO

APPR: RDEROSS

2020/04/30

2020/05/13

2020/08/11

2006/05/11

2006/05/11

DOCUMENT NUMBER: SD-38770-003

DOC TYPE: PSD

DOC PART: 001

REVISION: A1

MATERIAL NUMBER: SEE CHART

CUSTOMER: GENERAL MARKET

SHEET NUMBER: 1 OF 2



molex

9.53MM [.375] DOUBLE ROW
LOW PROFILE BTS ASSY

PRODUCT CUSTOMER DRAWING

NO. OF CIRCUITS "XX"	DIM. "A"		DIM. "B"		DIM. "C"		DIM. "D"		ASSEMBLY MATERIAL NO. (STANDARD)	ASSEMBLY MATERIAL NO. (-49 OPTION)	ASSEMBLY MATERIAL NO. (-50 OPTION)
	mm	INCH	mm	INCH	mm	INCH	mm	INCH			
2	35.7	[1.41]	9.53	[.375]	28.6	[1.13]	21.3	[.84]	387701902	387702002	387703102
3	45.2	[1.78]	19.05	[.750]	38.1	[1.50]	30.8	[1.21]	387701903	387702003	387703103
4	54.7	[2.16]	28.58	[1.125]	47.6	[1.88]	40.3	[1.59]	387701904	387702004	387703104
5	64.3	[2.53]	38.10	[1.500]	57.2	[2.25]	49.8	[1.96]	387701905	387702005	387703105
6	73.8	[2.91]	47.63	[1.875]	66.7	[2.63]	59.4	[2.34]	387701906	387702006	387703106
7	83.3	[3.28]	57.15	[2.250]	76.2	[3.00]	68.9	[2.71]	387701907	387702007	387703107
8	92.8	[3.66]	66.68	[2.625]	85.7	[3.38]	78.4	[3.09]	387701908	387702008	387703108
9	102.4	[4.03]	76.20	[3.000]	95.3	[3.75]	87.9	[3.46]	387701909	387702009	387703109
10	111.9	[4.41]	85.73	[3.375]	104.8	[4.13]	97.5	[3.84]	387701910	387702010	387703110
11	121.4	[4.78]	95.25	[3.750]	114.3	[4.50]	107.0	[4.21]	387701911	387702011	387703111
12	130.9	[5.16]	104.78	[4.125]	123.8	[4.88]	116.5	[4.59]	387701912	387702012	387703112
13	140.5	[5.53]	114.30	[4.500]	133.4	[5.25]	126.0	[4.96]	387701913	387702013	387703113
14	150.0	[5.91]	123.83	[4.875]	142.9	[5.63]	135.6	[5.34]	387701914	387702014	387703114
15	159.5	[6.28]	133.35	[5.250]	152.4	[6.00]	145.1	[5.71]	387701915	387702015	387703115
16	169.0	[6.66]	142.88	[5.625]	161.9	[6.38]	154.6	[6.09]	387701916	387702016	387703116
17	178.6	[7.03]	152.40	[6.000]	171.5	[6.75]	164.1	[6.46]	387701917	387702017	387703117
18	188.1	[7.41]	161.93	[6.375]	181.0	[7.13]	173.7	[6.84]	387701918	387702018	387703118
19	197.6	[7.78]	171.45	[6.750]	190.5	[7.50]	183.2	[7.21]	387701919	387702019	387703119
20	207.1	[8.16]	180.98	[7.125]	200.0	[7.88]	192.7	[7.59]	387701920	387702020	387703120
21	216.7	[8.53]	190.50	[7.500]	209.6	[8.25]	202.2	[7.96]	387701921	387702021	387703121
22	226.2	[8.91]	200.03	[7.875]	219.1	[8.63]	211.8	[8.34]	387701922	387702022	387703122
23	235.7	[9.28]	209.55	[8.250]	228.6	[9.00]	221.3	[8.71]	387701923	387702023	387703123
24	245.2	[9.66]	219.08	[8.625]	238.1	[9.38]	230.8	[9.09]	387701924	387702024	387703124
25	254.2	[10.03]	228.60	[9.000]	247.7	[9.75]	240.3	[9.46]	387701925	387702025	387703125
26	264.3	[10.41]	238.13	[9.375]	257.2	[10.13]	249.9	[9.84]	387701926	387702026	387703126
27	273.8	[10.78]	247.65	[9.750]	266.7	[10.50]	259.4	[10.21]	387701927	387702027	387703127
28	283.3	[11.16]	257.18	[10.125]	276.2	[10.88]	268.9	[10.59]	387701928	387702028	387703128
29	292.9	[11.53]	266.70	[10.500]	285.8	[11.25]	278.4	[10.96]	387701929	387702029	387703129
30	302.4	[11.91]	276.23	[10.875]	295.3	[11.63]	288.0	[11.34]	387701930	387702030	387703130

TOLERANCES			
MM	TOL	INCH	TOL
0-6	±0.25	0-.24	±.010
>6-30	±0.40	.24-1.18	±.016
>30-120	±0.50	1.18-4.76	±.020
>120	±0.80	>4.76	±.031

FUNCTIONAL SYMBOLS												THIS DRAWING CONTAINS INFORMATION THAT IS PROPRIETARY TO MOLEX ELECTRONIC TECHNOLOGIES, LLC AND SHOULD NOT BE USED WITHOUT WRITTEN PERMISSION															
DIMENSION UNITS				SCALE				CURRENT REV DESC: MIGRATED TO ECTR/NX & ADDED TOLERANCE TABLE				 9.53MM [.375] DOUBLE ROW LOW PROFILE BTS ASSY															
MM/INCH				2:1																							
GENERAL TOLERANCES (UNLESS SPECIFIED)												EC NO: 642242 DRWN: ABENJAMINLW 2020/04/30 CHK'D: MBRZOZOWSKI 2020/05/13 APPR: JFMURPHY 2020/08/11 INITIAL REVISION: DRWN: AHIDALGO 2006/05/11 APPR: RDEROSS 2006/05/11															
4 PLACES		± --- ± ---		3 PLACES		± --- ± ---		2 PLACES		± --- ± ---						1 PLACE		± --- ± ---		0 PLACES		± --- ± ---					
3 PLACES		± --- ± ---		2 PLACES		± --- ± ---		1 PLACE		± --- ± ---						0 PLACES		± --- ± ---		ANGULAR TOL		± ---					
3 PLACES		± --- ± ---		2 PLACES		± --- ± ---		1 PLACE		± --- ± ---						0 PLACES		± --- ± ---		ANGULAR TOL		± ---					
2 PLACES		± --- ± ---		1 PLACE		± --- ± ---		0 PLACES		± --- ± ---						ANGULAR TOL		± ---									
DIVISIONAL SYMBOLS				THIRD ANGLE PROJECTION				DRAWING				SERIES				MATERIAL NUMBER				CUSTOMER				SHEET NUMBER			
								B-SIZE				38770				SEE CHART				GENERAL MARKET				2 OF 2			

NO. OF CIRCUITS 'XX'	DM. 'A'	DM. 'B'	DM. 'C'	DM. 'D'	ASSEMBLY MATERIAL NO. (STANDARD)	ASSEMBLY MATERIAL NO. (-49 OPTION)	ASSEMBLY MATERIAL NO. (-50 OPTION)
2	35.7 [1.41]	9.53 [.375]	28.6 [1.13]	21.3 [.84]	387701902	387702002	387703102
3	45.2 [1.78]	19.05 [.750]	38.1 [1.50]	30.8 [1.21]	387701903	387702003	387703103
4	54.7 [2.16]	28.58 [1.125]	47.6 [1.88]	40.3 [1.59]	387701904	387702004	387703104
5	64.3 [2.53]	38.10 [1.500]	57.2 [2.25]	49.8 [1.96]	387701905	387702005	387703105
6	73.8 [2.91]	47.63 [1.875]	66.7 [2.63]	59.4 [2.34]	387701906	387702006	387703106
7	83.3 [3.28]	57.15 [2.250]	76.2 [3.00]	68.9 [2.71]	387701907	387702007	387703107
8	92.8 [3.66]	66.68 [2.625]	85.7 [3.38]	78.4 [3.09]	387701908	387702008	387703108
9	102.4 [4.03]	76.20 [3.000]	95.3 [3.75]	87.9 [3.46]	387701909	387702009	387703109
10	111.9 [4.41]	85.73 [3.375]	104.8 [4.13]	97.5 [3.84]	387701910	387702010	387703110
11	121.4 [4.78]	95.25 [3.750]	114.3 [4.50]	107.0 [4.21]	387701911	387702011	387703111
12	130.9 [5.16]	104.78 [4.125]	123.8 [4.88]	116.5 [4.59]	387701912	387702012	387703112
13	140.5 [5.53]	114.30 [4.500]	133.4 [5.25]	126.0 [4.96]	387701913	387702013	387703113
14	150.0 [5.91]	123.83 [4.875]	142.9 [5.63]	135.6 [5.34]	387701914	387702014	387703114
15	159.5 [6.28]	133.35 [5.250]	152.4 [6.00]	145.1 [5.71]	387701915	387702015	387703115
16	169.0 [6.66]	142.88 [5.625]	161.9 [6.38]	154.6 [6.09]	387701916	387702016	387703116
17	178.6 [7.03]	152.40 [6.000]	171.5 [6.75]	164.1 [6.46]	387701917	387702017	387703117
18	188.1 [7.41]	161.93 [6.375]	181.0 [7.13]	173.7 [6.84]	387701918	387702018	387703118
19	197.6 [7.78]	171.45 [6.750]	190.5 [7.50]	183.2 [7.21]	387701919	387702019	387703119
20	207.1 [8.16]	180.98 [7.125]	200.0 [7.88]	192.7 [7.59]	387701920	387702020	387703120
21	216.7 [8.53]	190.50 [7.500]	209.6 [8.25]	202.2 [7.96]	387701921	387702021	387703121
22	226.2 [8.91]	200.03 [7.875]	219.1 [8.63]	211.8 [8.34]	387701922	387702022	387703122
23	235.7 [9.28]	209.55 [8.250]	228.6 [9.00]	221.3 [8.71]	387701923	387702023	387703123
24	245.2 [9.66]	219.08 [8.625]	238.1 [9.38]	230.8 [9.09]	387701924	387702024	387703124
25	254.8 [10.03]	228.60 [9.000]	247.7 [9.75]	240.3 [9.46]	387701925	387702025	387703125
26	264.3 [10.41]	238.13 [9.375]	257.2 [10.13]	249.9 [9.84]	387701926	387702026	387703126
27	273.8 [10.78]	247.65 [9.750]	266.7 [10.50]	259.4 [10.21]	387701927	387702027	387703127
28	283.3 [11.16]	257.18 [10.125]	276.2 [10.88]	268.9 [10.59]	387701928	387702028	387703128
29	292.9 [11.53]	266.70 [10.500]	285.8 [11.25]	278.4 [10.96]	387701929	387702029	387703129
30	302.4 [11.91]	276.23 [10.875]	295.3 [11.63]	288.0 [11.34]	387701930	387702030	387703130

INITIAL RELEASE EC NO: ETC2006-0393 DRW: AHIDALGO 2006/05/11 CHKD: JENCINAS 2006/05/11 APPR: RDEROSS 2006/05/11	DESCRIPTION A	QUALITY SYMBOLS ▽=0 ▽=0	GENERAL TOLERANCES (UNLESS SPECIFIED) mm INCH 4 PLACES ± --- ±.0002 3 PLACES ± 0.000 ±.005 2 PLACES ± 0.13 ±.01 1 PLACE ± 0.3 ± --- ANGULAR ± 2 °	DIMENSION STYLE MM/IN DRAWN BY DATE AHIDALGO 2006/04/18 CHECKED BY DATE JENCINAS 2006/04/18 APPROVED BY DATE RDEROSS 2006/04/18	SCALE 2:1 DESIGN UNITS INCH THIRD ANGLE PROJECTION	TITLE 9.53MM [.375] DOUBLE ROW LOW PROFILE BTS ASSY
		DRAFT WHERE APPLICABLE MUST REMAIN WITHIN DIMENSIONS	MATERIAL NO. SEE CHART	DOCUMENT NO. SD-38770-003	SHEET NO. 2 OF 2	
		THIS DRAWING CONTAINS INFORMATION THAT IS PROPRIETARY TO MOLEX INCORPORATED AND SHOULD NOT BE USED WITHOUT WRITTEN PERMISSION				
		MOLEX INCORPORATED				