



## Quartz Crystal Specification

IQD Part No. + Packaging: LFX TAL066742Reel

Würth Part No. 830066742



### Description

- Standard 1.6 x 1.2mm SMD crystal in a hermetically sealed ceramic package with a sealed metal lid
- Model IQXC-26
- Model Issue number 4

### Frequency Parameters

- Frequency 26.00MHz
- Frequency Tolerance  $\pm 15.00$ ppm
- Tolerance Condition @ 25°C
- Frequency Stability  $\pm 15.00$ ppm
- Operating Temperature Range -20.00 to 70.00°C
- Overtone Order Fundamental
- Ageing  $\pm 5$ ppm max per year @ 25°C

### Electrical Parameters

- Load Capacitance (CL) 8.00pF
- Shunt Capacitance (C0) 7pF max
- Drive Level 100 $\mu$ W max
- ESR 200.00 $\Omega$  max

### Environmental Parameters

- Storage Temperature Range: -40 to 85°C
- Shock: IEC 60068-2-27: 1000G, 1ms, 3 times in each of 3 mutually perpendicular planes
- Vibration: IEC 60068-2-6: 1.5mm amplitude, 10Hz-55Hz, 1min in 3 mutually perpendicular planes, duration 2hrs each plane (total 6hrs)

### Compliance

- RoHS Status (2015/863/EU) Compliant
- REACH Status Compliant
- MSL Rating (JDEC-STD-033): Not Applicable

### Packaging Details

- Pack Style: Reel Tape & reel in accordance with EIA-481-D  
Pack Size: 3,000
- Alternative packing option available

## USEFUL LINKS

#### Toolbox:

[www.we-online.com/toolbox](http://www.we-online.com/toolbox)

#### Product Catalog:

[www.we-online.com/products](http://www.we-online.com/products)

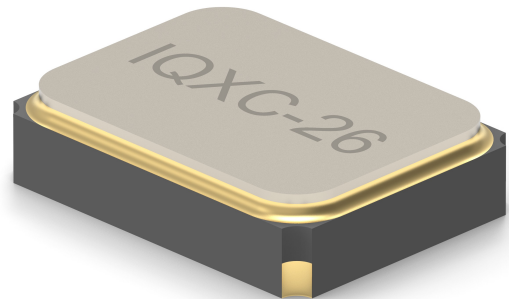

### Outline (mm)

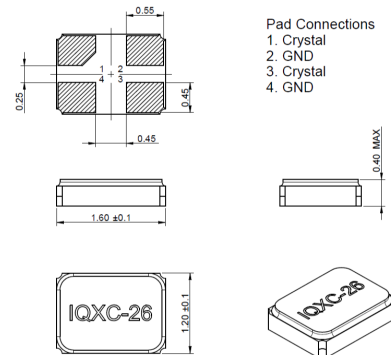

NOTE: The pad style on the base of the device may differ slightly from the drawing. The chamfer may appear on pad 1 or 4. This causes no change to the electrical performance of the device.

### Recommended Solder Pad Layout

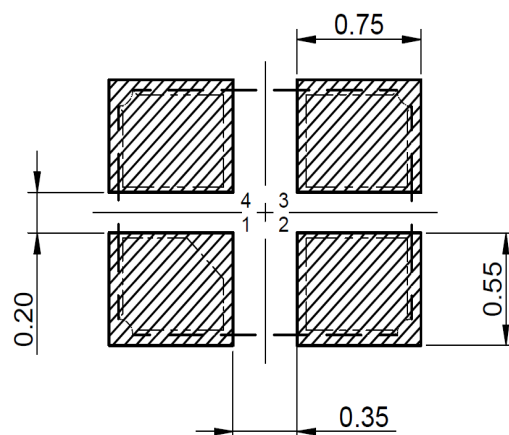

### CONTACT INFORMATION:

Würth Elektronik eiSos GmbH & Co. KG  
Max-Eyth-Str. 1, 74638 Waldenburg, Germany  
Tel: +49(0) 7942 945-0

Email: [eiSos@we-online.de](mailto:eiSos@we-online.de)  
Web: [www.we-online.com](http://www.we-online.com)