



# LTH3MM12V Series

## 3mm (T-1) Through Hole LED

### Built in Resistor for 12VDC



#### LTH3MM12VFR4400 - White Water-Clear T-1 (3 mm) LED

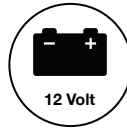

### Applications

- Automotive
- Indoor and Outdoor Indication
- Industrial
- Appliances and Consumer Equipments
- Storage Servers
- Boats
- Railway
- Electronic Devices
- Residential and Landscape Lighting
- Infrastructure

### Key Features

- Made with InGaN (White)
- Through-hole technology
- Integrated resistor for 12VDC operation
- With Flange
- Water-Clear Lens
- LED Bulb Size: 3mm (T-1), also available in 5mm (T-1 3/4)
- RoHS and REACH Compliant
- High-Brightness LED
- Available in 5 colors (red, green, white, blue and yellow)
- Viewing Angle: 30° (red, green, blue, yellow) and 35° (white)
- Moisture Sensitive Level (MSL): 2

## Ordering Data

The LTH3MM12V Series is available in a range of standard features and options. To specify your LED, simply choose one option from each column.

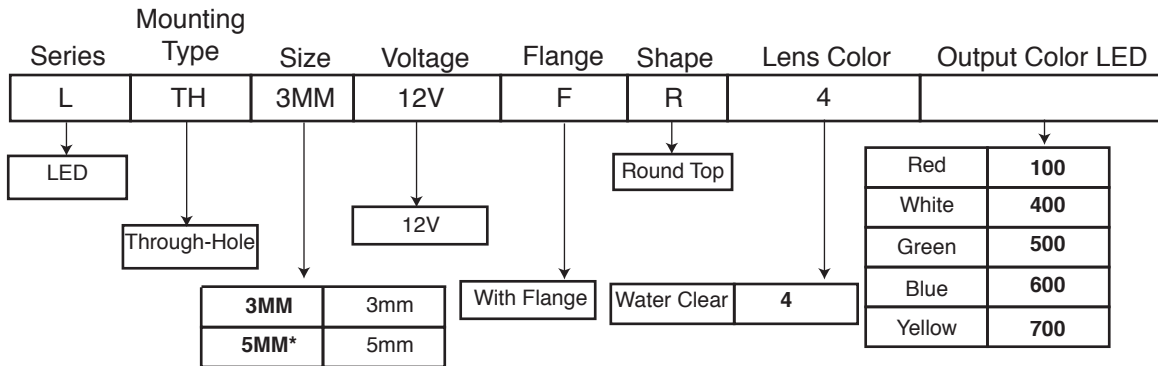

Part Numbers	Color
LTH3MM12VFR4100	Red
LTH3MM12VFR4400	White
LTH3MM12VFR4500	Green
LTH3MM12VFR4600	Blue
LTH3MM12VFR4700	Yellow

\*For 5mm option, please consult LTH5MM12V Series' datasheet

## Product Dimensions

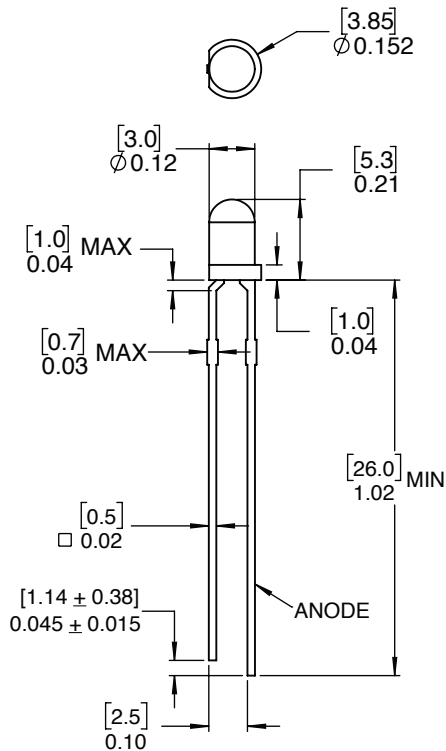

### Notes:

1. All dimensions are in [millimeters] inches
2. Tolerance is  $\pm[0.25]$  0.01 unless otherwise noted.
3. The specifications, characteristics and technical data described in the datasheet are subject to change without prior notice

## Product Dimensions

### ABSOLUTE MAXIMUM RATINGS

(Ta=25°C)

Parameter	Symbol	Ratings	Unit
Peak Forward Current (duty 1/10 @ 1KHz)	I <sub>FP</sub>	100	mA
Recommended Operating Current	I <sub>F(REC)</sub>	20	mA
Power Dissipation	P <sub>D</sub>	85	mW
Reverse Voltage	V <sub>R</sub>	5	V
Electrostatic Discharge	ESD	200	V
Operating Temperature Range	T <sub>OPR</sub>	-40~+85	°C
Storage Temperature Range	T <sub>STG</sub>	-40~+100	°C
Lead Soldering Temperature Range 1.6mm (1/16 inch) from body	T <sub>SOL</sub>	260°C for 5 seconds	

### OPTICAL-ELECTRICAL CHARACTERISTICS

(Ta=25°C)

Parameter	Symbol	Test Condition	Min	Typ	Max	Unit
Luminous Intensity	I <sub>v</sub>	I <sub>F</sub> =10mA	2200	4000	6500	mcd
Chromaticity Coordinates	x		--	0.29	--	nm
	y		--	0.31	--	nm
Forward Voltage	V <sub>F</sub>		10	12	13	V
Viewing Angle	2θ <sub>1/2</sub>		--	35	--	deg
Reverse Current	I <sub>R</sub>	V <sub>R</sub> =5V	--	--	10	μA

# Product Specifications

## Typical Electrical-Optical Characteristic Curves

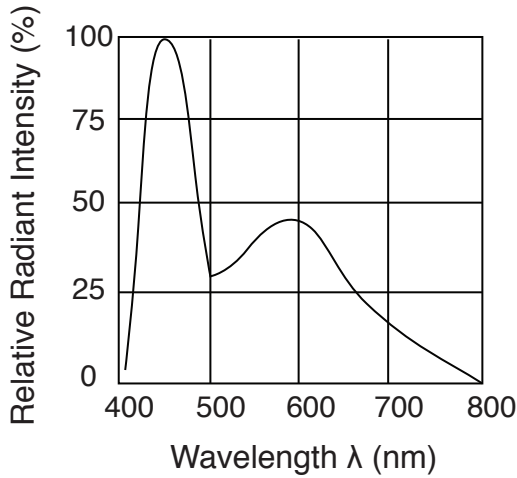

**Relative Radiant Intensity vs. Wavelength**

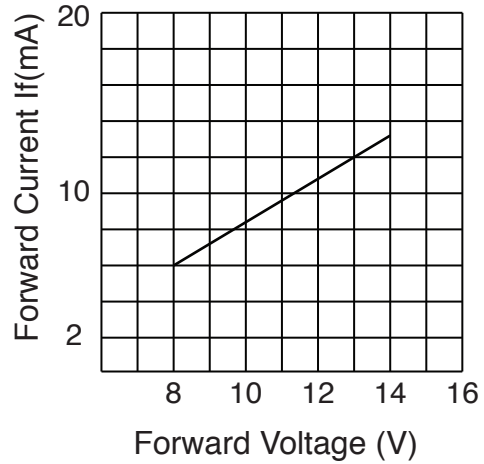

**Forward Current vs. Forward Voltage**

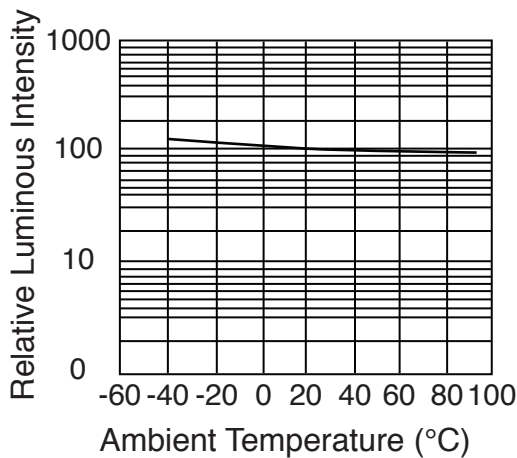

**Relative Luminous Intensity vs. Ambient Temperature**

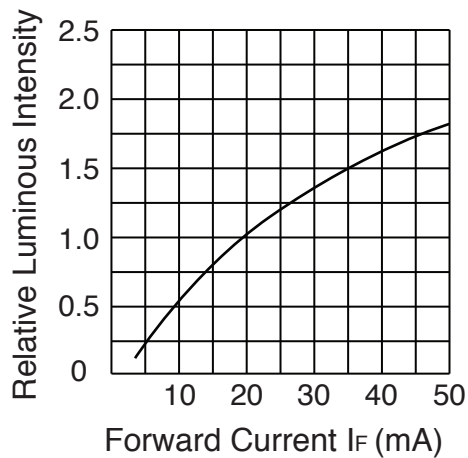

**Relative Luminous Intensity vs. Forward Current**

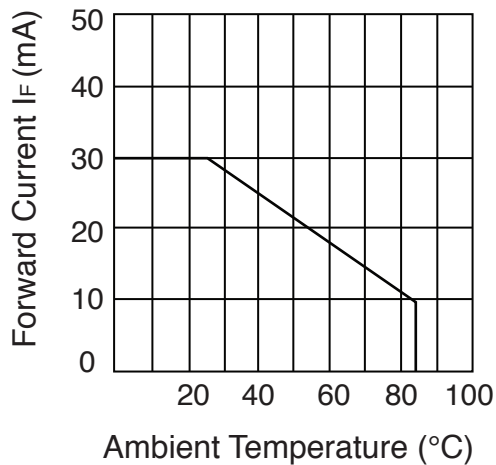

**Forward Current Derating Curve**

## Application Notes

### 1. Storage

The Storage Temperature and RH are: 5°C ~ 30°C, RH 60% or less.

We suggest our customers use our products within a year.

If the moisture absorbent material (silica gel) has faded away or the LEDs exceeded the storage time, bake treat more than 24 hours at 60°C ±5°C.

### 2. Electrostatic Discharge (ESD)

Static electricity or surge voltage will damage the LEDs.

Recommendations: Use a conductive wrist band or anti-electrostatic glove when handling these LEDs. All devices, equipment and machinery must be properly grounded.

Work tables, storage racks, etc. should be properly grounded. In the event of a manual working in process, make sure the devices are well protected from ESD at any time.

### 3. Recommended Soldering Condition

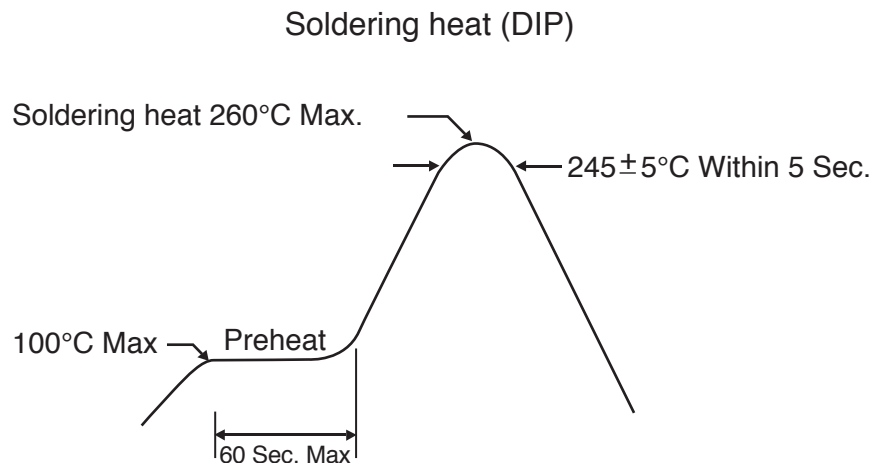

Temperature at tip of soldering iron: 350°C Max  
Soldering time: 3 sec ±1 sec (once only)

## Application Notes

### 4. Reflow Profile

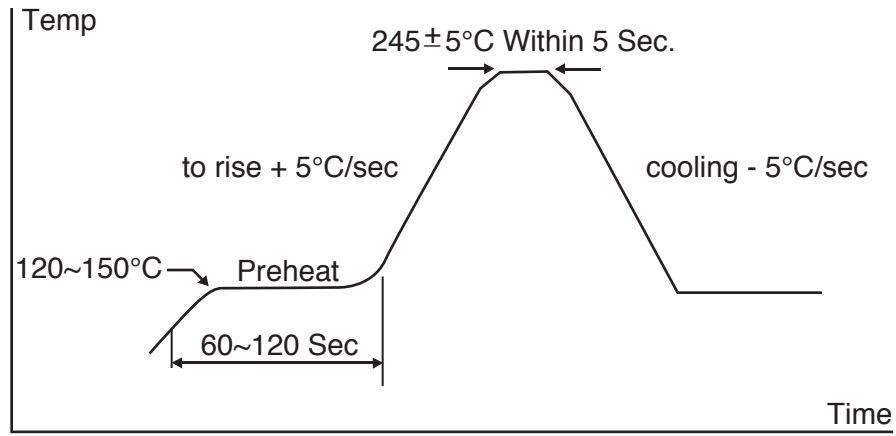

## Compliances and Approvals

