



ABSTRACT

This user's guide describes the characteristics, operation, and functionality of the BQ25790 Evaluation Module (EVM). It also describes the equipment, test setup, and software required to operate the EVM. A complete schematic diagram, printed-circuit board (PCB) layouts, and bill of materials (BOM) are also included in this document.

Throughout this user's guide, the abbreviations and terms *EVM*, *BQ25790EVM*, *BMS027*, and *evaluation module* are synonymous with the BQ25790 EVM.

Table of Contents

1 Introduction	3
1.1 EVM Features.....	3
1.2 I/O Descriptions.....	3
1.3 Recommended Operating Conditions.....	5
2 Test Setup and Results	6
2.1 Equipment.....	6
2.2 Equipment Setup.....	6
2.3 Software Setup.....	7
2.4 Test Procedure.....	7
3 PCB Layout Guidelines	13
4 Board Layout, Schematic and Bill of Materials	14
4.1 Board Layout.....	14
4.2 Schematic.....	18
4.3 Bill of Materials.....	20
5 Revision History	24

List of Figures

Figure 2-1. Equipment Test Setup for BMS027A.....	7
Figure 2-2. Single Bit Registers Section.....	8
Figure 2-3. Multi-Bit Register Section.....	9
Figure 2-4. 16-Bit Register Section.....	9
Figure 2-5. Icon Guide.....	9
Figure 2-6. Chip Configuration.....	10
Figure 2-7. Charger Configuration.....	10
Figure 2-8. Single-Bit Register Section.....	11
Figure 2-9. MultiBit Register Section.....	11
Figure 2-10. OTG Configuration Section.....	12
Figure 2-11. Chip Configuration.....	12
Figure 4-1. BMS027A Top Layer and Overlay.....	14
Figure 4-2. BMS027A Signal Layer 1.....	15
Figure 4-3. BMS027A Signal Layer 2.....	16
Figure 4-4. BMS027A Bottom Layer and Overlay.....	17
Figure 4-5. BQ25790EVM Schematic Page 1.....	18
Figure 4-6. BQ25790EVM Schematic Page 2.....	19

List of Tables

Table 1-1. Device Data Sheet.....	3
Table 1-2. EVM Connections.....	3
Table 1-3. EVM Shunt and Switch Installation.....	4

Table 1-4. Recommended Operating Conditions.....	5
Table 4-1. BMS027A Bill of Materials.....	20

Trademarks

Microsoft® and Windows® are registered trademarks of Microsoft Corporation.
All trademarks are the property of their respective owners.



WARNING

Hot surface! Contact may cause burns. Do not touch!

Some components may reach high temperatures >55°C when the board is powered on. The user must not touch the board at any point during operation or immediately after operating, as high temperatures may be present.

1 Introduction

The BQ25790 is an integrated switched-mode buck-boost battery charge management device in WCSP package, intended for 1- to 4-series cell Li-ion and Li-polymer batteries. The charger features a narrow VDC architecture (NVDC) which allows the system to be regulated to a minimum value even if the battery is completely discharged. Additionally, the BQ25790 supports input source detection through D+ and D- which is compatible with USB2.0, USB3.0 power delivery, non-standard adapters and many high voltage adapters. With dual input source selection, USB OTG support and an integrated 16-bit multi-channel analog-to-digital converter (ADC), the BQ25790 is a complete charging solution.

1.1 EVM Features

The BQ25790EVM is a complete module for evaluating the BQ25790 in the (WCSP) DSBGA package. Key features of this EVM include:

- Synchronous Switch Mode Buck-Boost Charger for 1s-4s Battery Configuration for 5-A Charging with 10-mA Resolution
- Support for 3.6-V to 24-V Wide Range of Input Sources USB Auto-Detect, USB PD and Wireless Input
- Dual Input Source Selector to Drive Bi-Directional Blocking NFETs
- Power up USB Port from Battery (USB OTG) with 2.8-V to 22-V OTG Output Voltage with 10-mV Resolution
- Low Battery Quiescent Current < 1 μ A in Shutdown Mode

The device datasheet, listed in [Table 1-1](#), provides detailed features and operation.

Table 1-1. Device Data Sheet

Device	Data Sheet
BQ25790	SLUSDF9

1.2 I/O Descriptions

[Table 1-2](#) lists the BQ25790EVM board connections and ports.

Table 1-2. EVM Connections

Connector/Port	Description	
J1	VIN1	Positive rail of the priority input adapter or power supply
	GND	Ground
J2	VIN2	Positive rail of the secondary input adapter or power supply
	GND	Ground
J3	SYSTEM	Positive rail of the charger system output voltage, typically connected to the system load
	GND	Ground
J4	VPMID	Positive rail of the charger output voltage for reverse mode (OTG). This output also shares the rail with VBUS in forward mode
	GND	Ground
J5	BATTERY	Positive rail of the charger battery input
	SNS_BATP	Input connected to the positive terminal of the battery for remote battery voltage measurement
	SNS_BATN	Input connected to the negative terminal of the battery for remote battery voltage measurement
	GND	Ground
J6	USB port	USB Micro B port used for input source type detection and handshaking. Connected to either VIN1 or VIN2
J7	EXTERNAL THERMISTOR	Input connected to an external battery temperature sensing thermistor
	GND	Ground
J8	Communication port	I ² C communication port for use with the EV2300/2400 Interface Board
J9	Communication port	I ² C communication port for use with the USB2ANY Interface Adapter

[Table 1-3](#) lists the shunt installations available on the EVM, and their respective descriptions.

Table 1-3. EVM Shunt and Switch Installation

Shunt	Description	BQ25790 Setting
JP1	ACDRV1 pin connection to control ACFET1-RBFET1. Connect this to _acdrv1 when utilizing the input protection MOSFETs. Connect this to GND when input protection MOSFETs are not utilized or bypassed.	ACDRV1 to _acdrv1
JP2	ACDRV2 pin connection to control ACFET2-RBFET2. Connect this to _acdrv2 when utilizing the input protection MOSFETs. Connect this to GND when input protection MOSFETs are not utilized or bypassed.	ACDRV2 to _acdrv2
JP3	VAC1 to VBUS bypass connection. Connect this when the input protection MOSFET feature is not desired. This will connect the input source on VIN1 to VBUS.	Not Installed
JP4	VAC2 to VBUS bypass connection. Connect this when the input protection MOSFET feature is not desired. This will connect the input source on VIN2 to VBUS.	Not Installed
JP5	BAT to BATTERY bypass connection. Connect this when the ship and shutdown mode features are not desired.	Not Installed
JP6	USB Micro B input D- connection to charger D- pin. Connect this when the input source detection and handshake features are desired.	Installed
JP7	USB input positive rail to charger input selection. Connect this to VAC1 to connect the USB input to the priority input rail.	USB_VIN to VAC1
JP8	Charger D+ and D- pin short connection. Connect this to simulate a DCP type adapter for the input source detection and handshake feature.	Not Installed
JP9	BATP pin to BATTERY connection. Connect this when remote battery terminal sensing is not desired and ship and shutdown mode features are being utilized. Do not connect if JP13 is shunt is connected.	Installed
JP10	USB Micro B input D+ connection to charger D+ pin. Connect this when the input source detection and handshake features are desired.	Installed
JP11	SDRV pin connection to control SFET. Disconnect when ship and shutdown mode features are not desired.	Installed
JP12	BATN pin to PGND connection. Connect this when remote battery terminal sensing is not desired.	Installed
JP13	BATP pin to BAT connection. Connect this when remote battery terminal sensing is not desired and ship and shutdown mode features are not being utilized. Do not connect if JP9 is shunt is connected.	Not Installed
JP14	REGN to TS resistor divider network connection. This must remain connected.	Installed
JP15	ILIM_HIZ pin setting for 500 mA. Connect to set the external input current limit setting to 500 mA.	Not Installed
JP16	ILIM_HIZ pin setting for 1.5 A. Connect to set the external input current limit setting to 500 mA.	Installed
JP17	Thermistor COOL temperature setting. Connect jumper to simulate charger entering TCOOL (T1-T2) temperature region.	Not Installed
JP18	Thermistor COLD temperature setting. Connect jumper to simulate charger entering TCOLD (<T1) temperature region.	Not Installed
JP19	\overline{CE} pin connection to ground to enable charging. When removed, \overline{CE} pin will pull up to disable charge.	Installed
JP20	Thermistor NORMAL temperature setting. Connect jumper to simulate charger entering TNORMAL (T2-T3) temperature region. Keep connected when testing other thermistor temperature settings (JP17 - TCOOL, JP18 - TCOLD, JP21 - TWARM, JP22 - THOT). Remove this jumper whenever using an externally connected thermistor.	Installed
JP21	Thermistor WARM temperature setting. Connect jumper to simulate charger entering TWARM (T3-T5) temperature region.	Not Installed
JP22	Thermistor HOT temperature setting. Connect jumper to simulate charger entering THOT (>T5) temperature region.	Not Installed
JP23	ILIM_HIZ pin setting for HIZ mode. Connect to enter the charger high impedance (HIZ) mode to disable the converter.	Not Installed
JP24	PROG pin setting for 1S, 1.5 MHz. Connect to configure charger default setting to 1S charge regulation voltage, 2-A charging current, and 1.5-MHz switching frequency.	Not Installed
JP25	PROG pin setting for 1S, 750 kHz. Connect to configure charger default setting to 1S charge regulation voltage, 2-A charging current, and 750-kHz switching frequency	Not Installed
JP26	PROG pin setting for 2S, 1.5 MHz. Connect to configure charger default setting to 2S charge regulation voltage, 2-A charging current, and 1.5-MHz switching frequency	Installed

Table 1-3. EVM Shunt and Switch Installation (continued)

Shunt	Description	BQ25790 Setting
JP27	PROG pin setting for 2S, 750 kHz. Connect to configure charger default setting to 2S charge regulation voltage, 2-A charging current, and 750-kHz switching frequency	Not Installed
JP28	PROG pin setting for 3S, 1.5 MHz. Connect to configure charger default setting to 3S charge regulation voltage, 1-A charging current, and 1.5-MHz switching frequency	Not Installed
JP29	PROG pin setting for 3S, 750 kHz. Connect to configure charger default setting to 3S charge regulation voltage, 1-A charging current, and 750-kHz switching frequency	Not Installed
JP30	PROG pin setting for 4S, 1.5 MHz. Connect to configure charger default setting to 4S charge regulation voltage, 1-A charging current, and 1.5-MHz switching frequency	Not Installed
JP31	PROG pin setting for 4S, 750 kHz. Connect to configure charger default setting to 4S charge regulation voltage, 1-A charging current, and 750-kHz switching frequency	Not Installed
JP32	Input connection for onboard PULLUP rail LDO. Connect to power onboard 3.3-V pull-up rail. LDO input will be connected via diode-OR between VBUS and BAT.	Installed
JP33	EV2400 internal pull up to PULLUP connection. Connect to use EV2400 internal 3.3-V pull up to drive the EVM PULLUP rail. ⁽¹⁾	Not Installed
JP34	\overline{PG} pin LED indicator connection. On \overline{PG} enabled chargers, this indicates the Power Good status.	Installed
JP35	STAT pin LED indicator connection. This indicates the current charger status.	Installed
JP36	USB2ANY internal pull up to PULLUP connection. Connect to use the USB2ANY internal 3.3-V pull up to drive the EVM PULLUP rail.	Not Installed
S1	\overline{QON} control switch. Press to either exit Ship Mode or reset the System Power.	Default Off

(1) EV2400 internal 3.3-V pullup rail is not active by default. Requires modification to the internal circuit of the EV2400.

1.3 Recommended Operating Conditions

Table 1-4. Recommended Operating Conditions

	Description	Min	Typ	Max	Unit
V(VINx) at J1 or J2	Power supply voltage to the external blocking FETs which allow power to VBUS pin	3.6		24	V
I(INx) into J1 or J2	Power supply current, which can be limited by the charger input current limit feature (IINDPM)	0.01		3.3	A
V(BATTERY) voltage at J5	Battery voltage supported for precharge	2.2	3.8(1S), 7.6(2S), 11.4(3S), 15.2V(4S)	18.8	V
I(BATTERY) out of/into J5	Battery charge current	0.01	2 (1S, 2S), 1(3S, 4S)	5	A
V(SYS) at J3	System voltage regulation range	3.2		19	V
I(SYS) out of J3	System load current	0		5	A

Note

If hotplugging adaptors with voltage greater than 15 volts, it is recommended to install RSNUB1, CSNUB1, RSNUB2, and CSBUB2 as listed on the schematic.

Note

If hotplugging 4S batteries and a shipFET is installed, it is recommended to install component CSNUB3 as listed on the schematic.

Note

If hotplugging 4S batteries and a shipFET is not installed, it is recommended to install component DVTS as listed on the schematic.

2 Test Setup and Results

2.1 Equipment

This section includes a list of supplies required to perform tests on the BQ25790EVM.

1. **Power Supplies for VBUS pin:** Power Supply #1 (PS1): A power supply capable of supplying up to 24 V at 3 A is required.
2. **Battery Simulator for BAT pin:** Load #1 (4-Quadrant Supply): A "Kepco" Load, BOP, 20-5M, DC 0 to ± 20 V, 0 to ± 5 A (or higher) or a Keithley 2450 3-A sourcemeter. When using both, a 1000- μ F or higher, low ESR, 25-V rated or higher connected at the EVM battery and ground terminals is recommended.
Alternative Option: A 0–20 V/0–5 A, > 60-W DC electronic load set in a constant voltage loading mode in parallel with a second power supply can be used. The second power supply is set to a voltage slightly below the electronic load's constant voltage setting. When enabled, the charger's charge current then replaces the current provided the second power supply.
3. **System load simulator for SYS pin:** Load #2(Electronic load set to constant resistance or Resistive Load): 10 Ω , 5 W (or higher)
4. **Meters:** (6x) "Fluke 75" multimeters, (equivalent or better).
Alternative Option: (4x) equivalent voltage meters and (2x) equivalent current meters. The current meters must be capable of measuring at least 5 A. If used in series between the PS#1, Load#1 or Load#2, the meters should be set for manual not auto ranging. Current meters add significant series resistance which affects charger performance.
5. **Computer:** A computer with at least one USB port and a USB cable. A valid internet connection is required when using the GUI Composer application.
6. **PC Communication Interface:** USB2ANY Interface Adapter (when using the GUI Composer application) or EV2300/2400 USB-Based PC Interface Board (when using Battery Management Studio).

2.2 Equipment Setup

Use the following list to set up the EVM testing equipment. Refer to [Figure 2-1](#) for the test setup connections to the EVM:

1. Review the EVM connections in [Table 1-2](#).
2. Set PS#1 for 5.0-V, 3-A current limit and then turn off the supply. Connect PS#1 to J1 (VIN1 and PGND).
3. Connect a voltage meter across TP21 (VBUS) and TP47 (PGND) to measure the input voltage as seen from the VBUS pins of the charger.
4. Connect a voltage meter across TP1 and TP2 (I_VAC1_SENSE) to measure the input current into the VBUS pins through the VIN1 path. Alternatively, you may connect a current meter between PS1 and J1.
5. Set Load #1 to constant voltage mode, capable of sinking (for example, compliance) at least 3 A, and output to 5.0 V, and then disable load. Connect Load #1 to J5 (BATTERY and PGND).
6. Connect a voltage meter across TP27 (BAT) and TP46 (PGND) to measure the battery voltage as seen from the BAT pins of the charger.
7. Connect a voltage meter across TP17 and TP18 (I_BAT_SENSE) to measure the battery charge current out of and discharge current into BAT pins. Alternatively, you may connect a current meter between Load #1 and J5.
8. Connect a voltage meter across TP26 (SYS) and TP48 (PGND) to measure the system voltage as seen from the SYS pins of the charger.
9. Install shunts as shown in [Table 1-3](#).

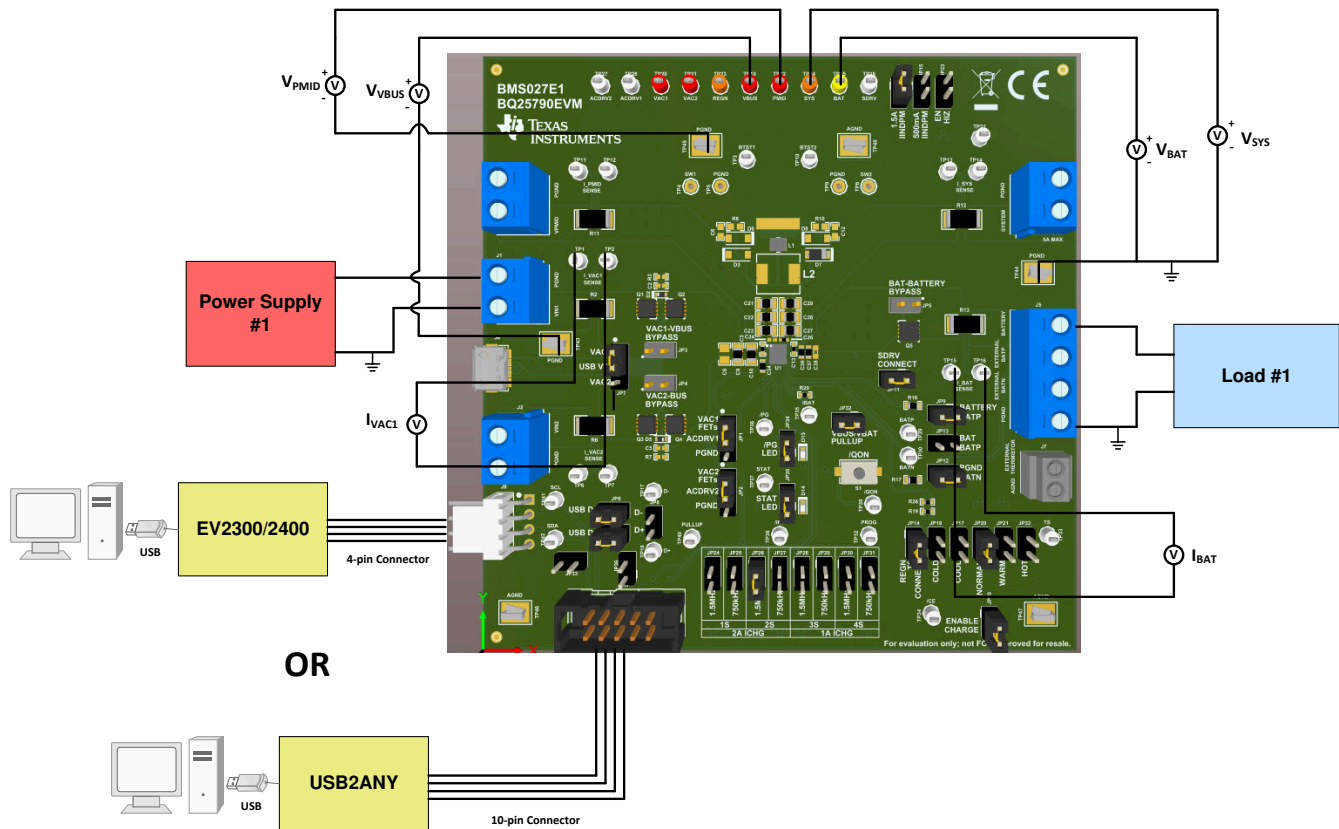

Figure 2-1. Equipment Test Setup for BMS027A

2.3 Software Setup

The charger is controlled by a state machine that uses I2C registers and the state machine makes decisions based off of the I2C registers. Software only helps with reading and writing to those registers.

2.3.1 BQSTUDIO using EV2400

Download the latest version of [BQSTUDIOTEST](#). Double click the *Battery Management Studio* installation file and follow the installation steps. The software supports Microsoft® Windows® XP, 7, and 10 operating systems. Launch BQSTUDIO and select *Charger*. If the EVM configuration file for BQSTUDIO does not appear in the Charger, close BQSTUDIO and either download the .BQZ file from the EVM product folder at www.ti.com or request the file via e2e.ti.com. The file must be saved into C:\XXX\BatteryManagementStudio\config, where XXX is the directory you selected to install BQSTUDIO.

2.3.2 TI Charger GUI for USB2ANY

Navigate to the [TI-CHARGER-GUI](#) tool folder. Once at the tool page click on the "Evaluate in the cloud" button. The browser will automatically be redirected to the TI Charger GUI landing page. From the landing page locate the device desired for evaluation and click "Select Device." Note that the EVM must be powered and the USB2ANY must be connected to both the EVM and the PC for a connection to be established. Also, update the USB2ANY to the latest version with the [USB2ANY Explorer Software](#).

2.4 Test Procedure

2.4.1 Initial Settings

Use the following steps to enable the EVM test setup.

1. Make sure [Section 2.2](#) steps have been followed.
2. Remove the shunt on JP19 to disable charge.
3. Make sure the PROG pin jumpers, JP22-JP29, are set to the desired frequency and cell count.
4. Make sure the TS Jumpers are installed to the correct positions if a thermistor is being simulated.

5. If using BQStudio, launch the BQSTUDIO software and select Charger then BQ25790EVM, if not already done.
6. If using TI Charger GUI, go to the [TI Charger GUI website](#) and select the charger from the list.
7. Turn on PS1 and Load #1:
 - **Measure** $\Rightarrow V_{\text{SYS-PGND}}$ (TP26 and TP48) = 8.55 V \pm 0.2 V
8. Verify $\overline{\text{PG}}$ LED (D13) is on.

Note

If the $\overline{\text{PG}}$ LED is not lit, confirm a valid PS1 is connected and the correct shunt configuration was placed.

Note

If the device is not communicating and does not ACK, verify that [Section 2.2](#) and [Section 2.4.1](#) steps have been followed. Verify the voltage across TP42 (PULLUP) and TP49 (AGND) is approximately 3.3 V.

2.4.2 Communication Verification

If using Battery Management Studio, use the following steps for communications verification:

1. In Battery Management Studio, select "READ REGISTER" at the top of the page. "Device ACK OK" should appear at the top of the page.
2. Select **Field View** in the top right of the screen. Note there are two tabs, one for 8-bit registers and one for 16-bit registers. In the 8-bit tab, there are sections for chip, charger and OTG single-bit and multi-bit registers. In the 16-bit tab are the charger and OTG multi-bit registers for setting voltages and currents. In addition, the ADC registers are on the 16-bit tab.
3. Prepare the charge mode charger register settings in the following way if not already set there by default:
 - On the **8-bit Registers tab** in the *Chip Config Single-bit Registers* section
 - Change Watchdog Timer to disabled
 - Check the "ShipFET Present?" check box

Chip Config Single-bit Registers			
<input type="checkbox"/> Reset all	<input checked="" type="checkbox"/> EN Charge	<input type="checkbox"/> EN HiZ	<input type="checkbox"/> WD Timer RST
<input type="checkbox"/> Disable 10s SDRV Delay	<input type="checkbox"/> EN OTG Mode	<input type="checkbox"/> EN 15ms /QON Wakeup Delay	<input type="checkbox"/> ENACDRV2
<input type="checkbox"/> ENACDRV1	<input type="checkbox"/> EN 750kHz PWM	<input type="checkbox"/> Disable STAT	<input checked="" type="checkbox"/> ShipFET Present?
<input type="checkbox"/> EN ADC	<input type="checkbox"/> Disable IBUS ADC	<input type="checkbox"/> Disable IBAT ADC	<input type="checkbox"/> Disable VBUS ADC
<input type="checkbox"/> Disable VBAT ADC	<input type="checkbox"/> Disable VSYS ADC	<input type="checkbox"/> Disable TS ADC	<input type="checkbox"/> Disable Die Temp ADC
Chip Config Multi-bit Registers			
Watchdog Timer	Disabled	SDRV Control	IDEL
ADC Rate	Continuous	ADC Resolution	12-bit
ADC Average	Single	ADC Average Start	Current Value

Figure 2-2. Single Bit Registers Section

- On the **8-bit Registers tab** in the *Charger Multi-bit Registers* section
 - Set the Precharge current to 240 mA
 - Set ABS VINDPM to 4000 mV
 - Set VSYSMIN to 7000 mV

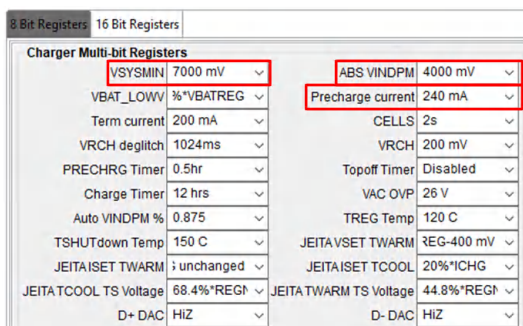

Figure 2-3. Multi-Bit Register Section

- On the **16-bit Registers** tab in the *Charger Multi-bit Registers* section
 - Set the Charge Voltage charging regulation limit to 8400 mV
 - Set the Charge Current to 500 mA.
 - Set the input current regulation limit (IINDPM) to 3000 mA.

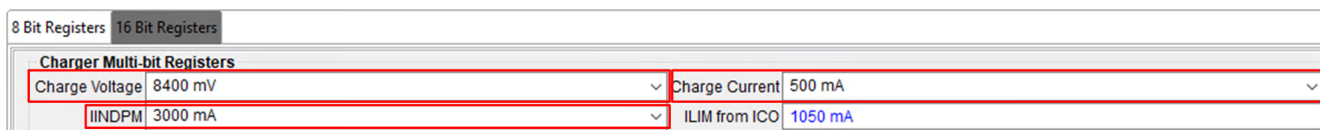

Figure 2-4. 16-Bit Register Section

If using TI Charger GUI, follow these steps.

- In the TI Charger GUI homepage, select the charger you are using. You should see at the bottom-left, Hardware Connected. Here is a brief description of what the icons on the left side panel mean:

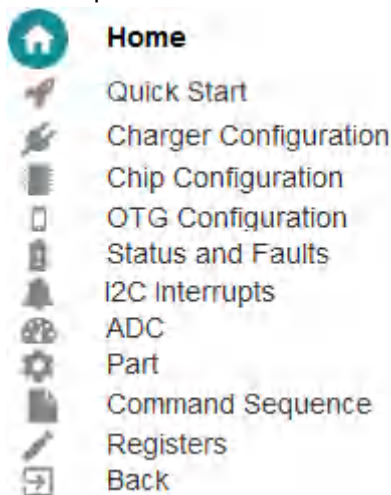
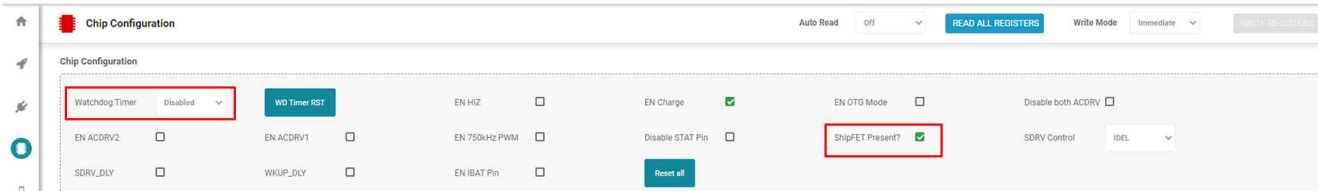

Figure 2-5. Icon Guide

Note

If the EVM is powered but not communicating (for example, does not ACK), try updating the USB2ANY firmware to the latest version using the software at . The software tells you to press the reset button, on the opposite side of the USB connector to the LED, using a paper clip or narrow pin.

- Go to the Chip Configuration and set the Watchdog Timer to disabled and check the "ShipFET present?" box.

Figure 2-6. Chip Configuration
3. Go to the Charger Configuration and set

- VSYSMIN to 7 V
- Charge Voltage to 8.4 V
- Charge Current to 0.5 A
- Precharge current to 0.24 A
- IINDPM to 3 A
- ABS VINDPM to 0.4 V

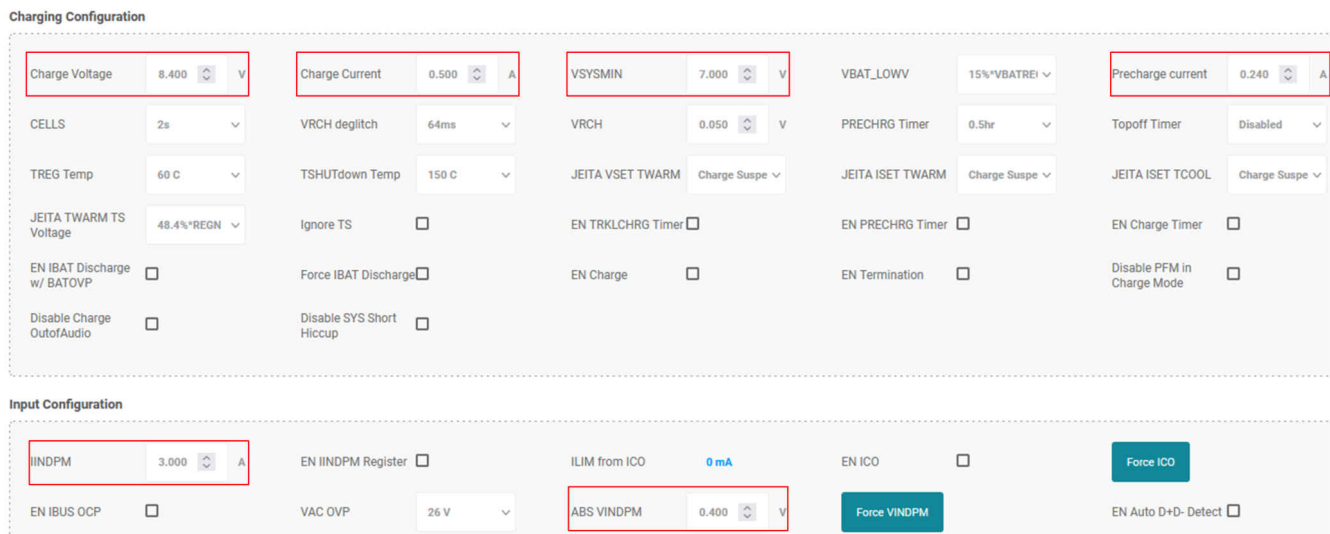
Figure 2-7. Charger Configuration
2.4.3 Charge Mode Verification

Use the following steps for charge mode verification, including precharge, CC and CV phases for boost operation:

1. PS1 and Load #1 should be on from [Section 2.4.1](#). In the EVM GUI, it is generally recommended to read REG22-REG27 (or READ ALL REGISTERS) one time in order to show all of the interrupts (from status changes, automated routine completion, faults) that occurred since the last read. Reading those registers a second clears the interrupts. After reading the registers,
 - **Verify** ⇒ REG1B reports all Normal, meaning no DPM loops active and no WD timer fault (bits 7-4), VAC1 Present (bit2), VBUS Present (bit 0) and Power Good (bit 3)
2. Reinstall the shunt on jumper J19 to enable charge
 - **Verify** ⇒ STAT LED (D14) is lit
3. Take measurements as follows:
 - **Measure** ⇒ $V_{VBUS-PGND}$ (TP21 and TP45) = 5.0 V ±0.2 V
 - **Measure** ⇒ $V_{BAT-PGND}$ (TP27 and TP46) = 5.0 V ±0.2 V
 - **Measure** ⇒ I_{BAT_SENSE} (voltage across 0.01-Ω resistor between TP17 and TP18) = 240 mA ±60 mA
 - **Click READ ALL REGISTERS and Verify** ⇒ REG1Cb[7:5] reports precharge
4. Increase Load #1 regulation voltage to 8.0 V and take measurements as follows:
 - **Measure** ⇒ $V_{VBUS-PGND}$ (TP21 and TP45) = 5.0 V ±0.2 V
 - **Measure** ⇒ $V_{BAT-PGND}$ (TP27 and TP46) = 8.0 V ±0.1 V
 - **Measure** ⇒ I_{BAT_SENSE} (voltage across 0.01-Ω resistor between TP17 and TP18) = 500 mA ±50 mA
 - **Measure** ⇒ I_{VAC1_SENSE} (voltage across 0.01-Ω resistor between TP1 and TP2) = 900 mA ±60 mA

- Click **READ ALL REGISTERS and Verify** ⇒ REG1Cb[7:5] reports fast charge
- Increase Load #1 regulation voltage to 8.4 V and take measurements as follows:
 - **Measure** ⇒ $V_{BAT-PGND}$ (TP27 and TP46) = 8.4 V ±0.04 V
 - **Measure** ⇒ I_{BAT_SENSE} (voltage across 0.01-Ω resistor between TP17 and TP18) = 0 mA ±10 mA
 - Click **READ ALL REGISTERS and Verify** ⇒ REG1Cb[7:5] reports termination
 - Helpful hints when changing voltages and register settings during charge mode:
 - If increasing charge current or adding a load at the SYS J3 terminal, disabling the EN_ILIM (EN_EXTLIM) bit using 8-bit register tab/Charger Single-bit Registers/REG14b[1] and increasing the IINDPM register setting in 16-bit register tab/Charger Multi-bit Registers/REG06b[8:0] will likely be needed.
 - If increasing the input voltage above 8 V for the charger to enter buck mode, increase the VAC_OVP from 7 V default using 8-bit register tab/Charger Multi-bit Registers/REG10b[5:4].
 - The battery configuration is set at startup using the PROG pin (Jumpers JP24 to JP31). The battery configuration can also be changed using 16-bit register tab/Charger Multi-bit Registers/REG0Ab[7:6]. Note that the SYSMIN and charge current charge with cell configuration.
 - The status, fault and interrupt bits report are helpful debug tools.

2.4.4 OTG Mode Verification

Use the following steps for OTG mode verification for boost operation:

- Power up then turn off Load#2 output. Set to CR = 12 V/0.5 A = 24 Ω. Disconnect PS1 from J1 and attach Load#2 to J1 (VIN1 and GND).
- Increase Load #1 regulation voltage to 8.0 V and take measurements as follows:
 - **Measure** ⇒ $V_{BAT-PGND}$ (TP27 and TP46) = 8.0 V ±0.1 V
- For BQStudio, prepare the OTG mode charger register settings in the following way:
 - On the **8-bit Registers tab** in the *Chip Config Single-bit Registers* section:
 - Check the EN OTG Mode box
 - Check the EN ACDRV1 box
 - On the **8-bit Registers tab** in the *OTG Multi-bit Registers* section:
 - Set IOTG 1000 mA to change the OTG current limit.

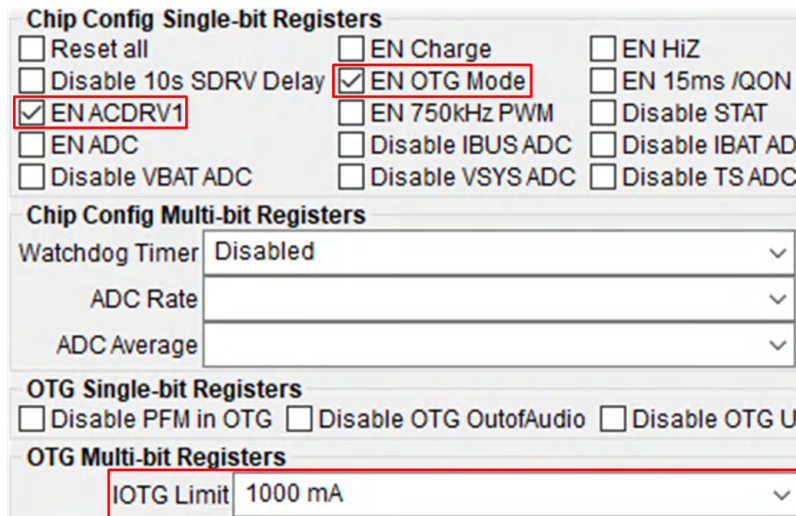

Figure 2-8. Single-Bit Register Section

- On the **16-bit Registers tab** in the *OTG Multi-bit Registers* section:
 - Set the OTG mode regulation voltage to 12000 mV

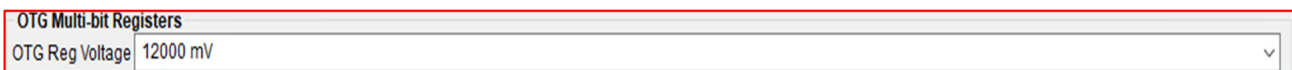

Figure 2-9. MultiBit Register Section

For GUI composer, go to OTG Configuration Section and change the following registers:

- OTG Reg Voltage to 12 V
- IOTG Limit to 1 A.



Figure 2-10. OTG Configuration Section

Next go to the Chip configuration and check the EN OTG Mode box and EN ACDRV1 box.

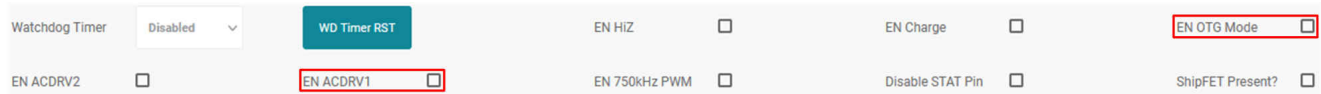

Figure 2-11. Chip Configuration

- Take measurements as follows:
 - **Measure** $\Rightarrow V_{VBUS-PGND}$ (TP21 and TP45) = 12.0 V \pm 0.2 V
 - **Measure** $\Rightarrow V_{AC1-PGND}$ (TP22 and TP45) = 12.0 V \pm 0.2 V
 - **Click READ ALL REGISTERS**
 - **Verify** \Rightarrow REG1Bb[6] reports VINDPM or OTG
 - **Verify** \Rightarrow REG1Cb[4:1] reports VBUS Status as Normal OTG
- Turn on Load#2 output set to CR of 24 Ω .
- Take measurements as follows:
 - **Measure** $\Rightarrow V_{AC1-PGND}$ (TP22 and TP45) = 12.0 V \pm 0.2 V
 - **Measure** $\Rightarrow I_{AC1-SENSE}$ (TP1 and TP2) = 500 mA \pm 0.10 A
- Lower the Load#2 CR to 10 Ω .
- Take measurements as follows to confirm OTG current function:
 - **Measure** $\Rightarrow V_{AC1-PGND}$ (TP22 and TP45) < 12.0 V \pm 0.2 V
 - **Measure** $\Rightarrow I_{AC1-SENSE}$ (TP1 and TP2) = 1000 mA \pm 0.10 A
 - **Click READ ALL REGISTERS and Verify** \Rightarrow REG1Bb[7] reports IINDPM
- Hints for further OTG testing:
 - Enabling OTG mode is a two-step process, first enable OTG and then turn on the appropriate AC drive FETs.

3 PCB Layout Guidelines

Careful placement of components is critical in order for the charger to meet specifications. The items below are listed in order of placement priority.

1. Place high frequency decoupling capacitors for PMID and SYS (C24 and C26 on the EVM) as close possible to their respective pins and ground pin on the same layer as the charger IC (in other words, no vias) in order to have the smallest current loop.
2. Place bulk capacitors for PMID and SYS as close possible to their respective pins and the charger's ground pin on the same layer as the charger IC on the same layer as the charger IC (in other words, no vias).
3. Place the REGN capacitor (C34) to ground and BTST capacitors (C3 and C13) to SW as close as possible to their respective pins only using vias for 1 side of each component if necessary.
4. Place high frequency decoupling capacitors for VBUS and BAT pins as close as possible to their respective pins. Use at least 2 vias per capacitor terminal if required.
5. Place bulk capacitors for VBUS and BAT pins as close as possible to their respective pins. Use at least 2 vias per capacitor terminal if required.
6. Place the inductor close to SW1 and SW2 pins. It is acceptable to use multiple vias to make these connections as the vias are only adding small amounts of inductance and resistance to an inductor.
7. While this EVM has analog ground (AGND) and power ground (PGND) planes that connect close to the charge GND pin, two grounds not required. Resistors and capacitors used for setting sensitive nodes (for example, ILIM, TS) can use one common ground plane but with their ground terminals connected away from high current ground return paths containing switching noise.

Note that this EVM has test points and jumpers requiring traces out to the PCB edges. Routing these traces required some PCB layout compromises for less critical components than those listed in the first six items above.

4 Board Layout, Schematic and Bill of Materials

4.1 Board Layout

Figure 4-1 through Figure 4-4 illustrate the PCB board layout.

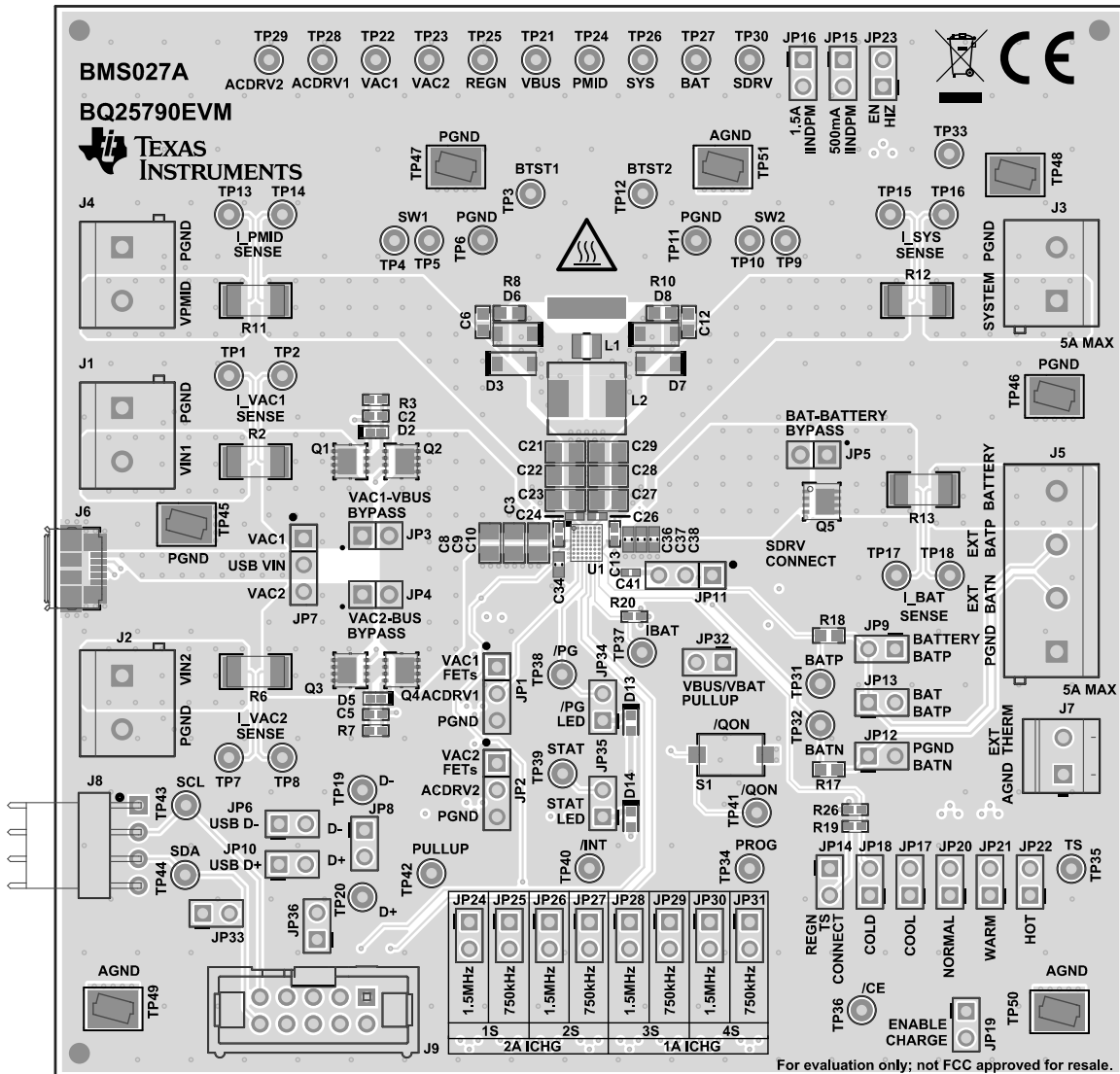

Figure 4-1. BMS027A Top Layer and Overlay

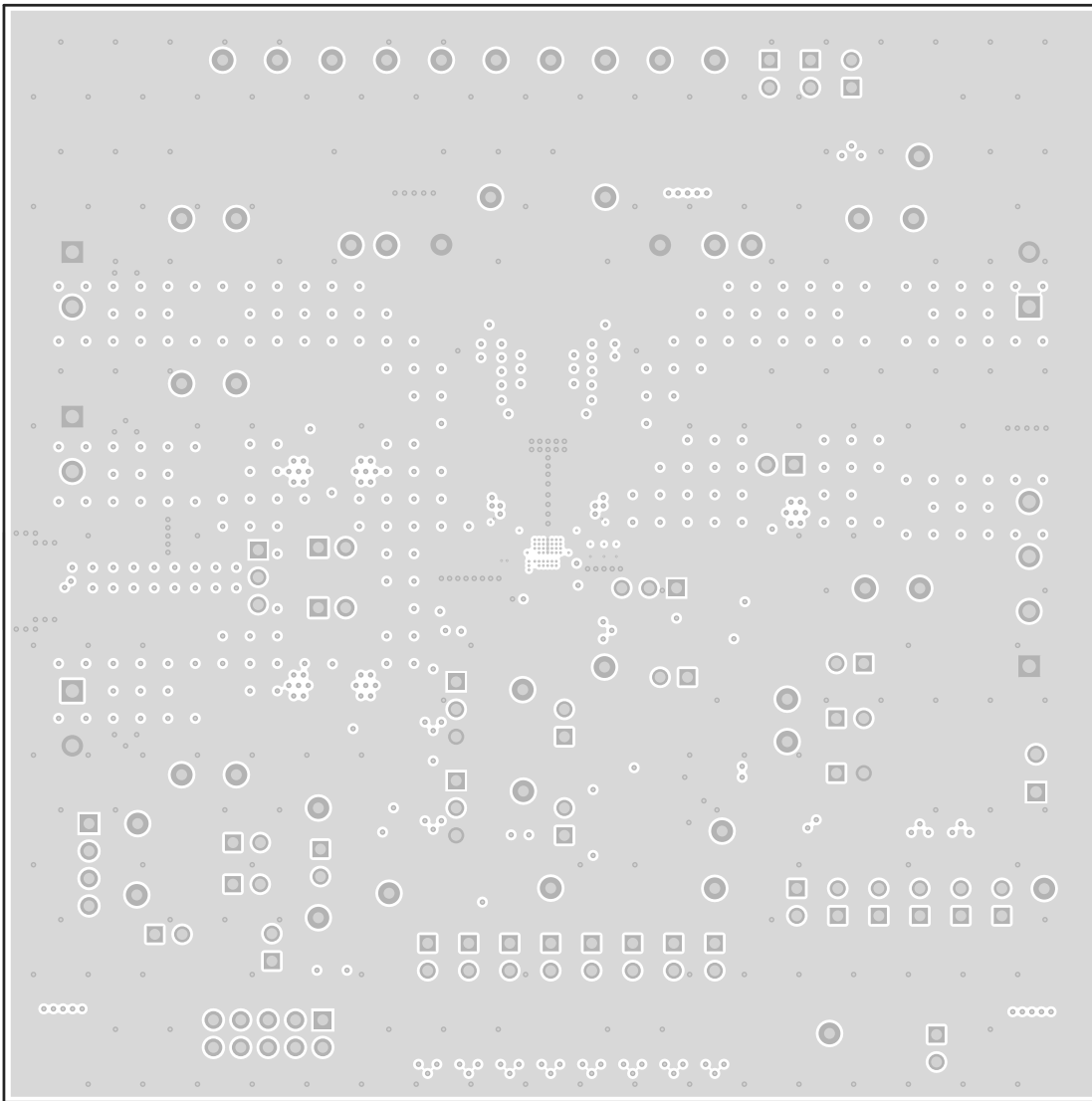

Figure 4-2. BMS027A Signal Layer 1

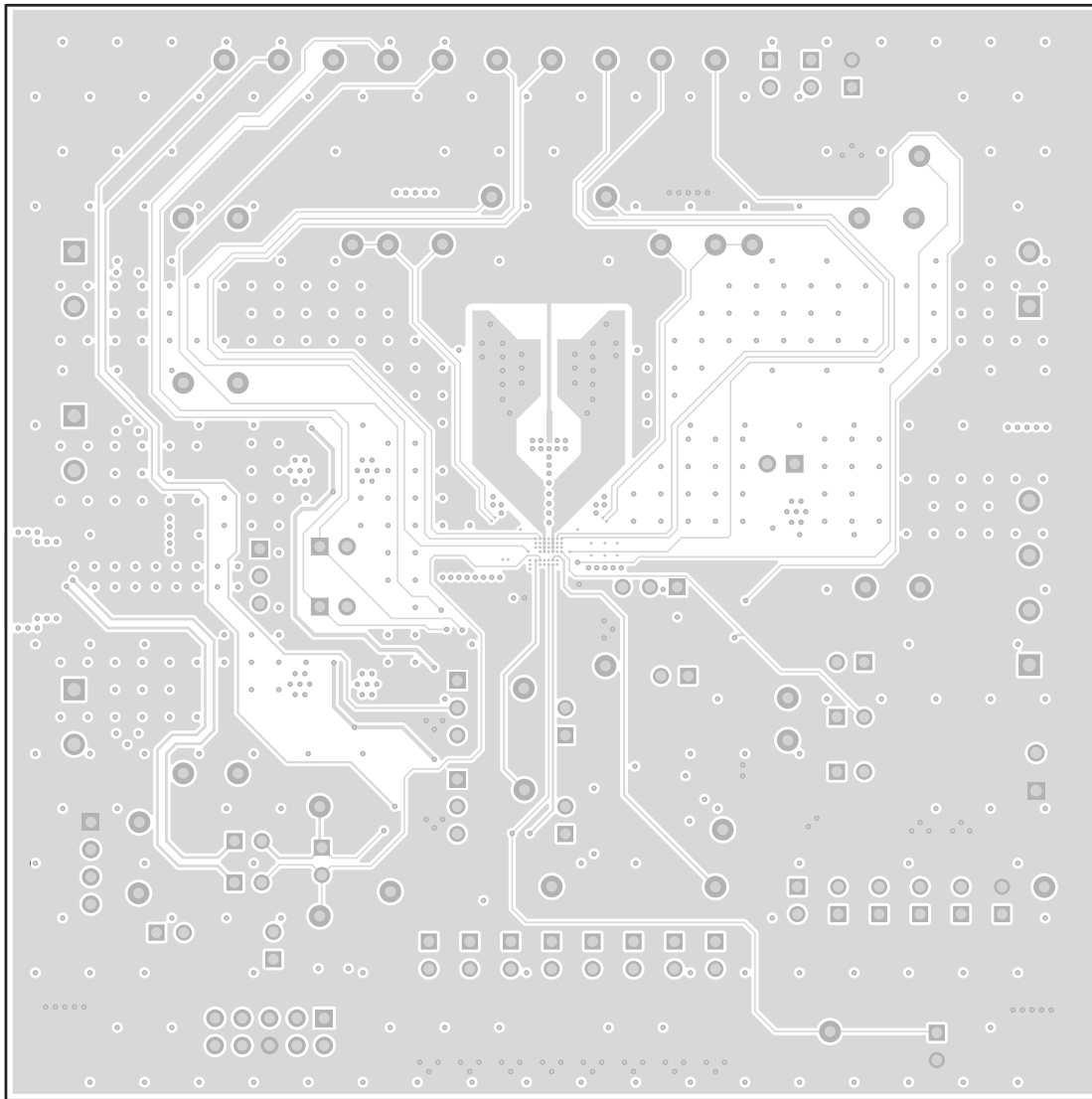

Figure 4-3. BMS027A Signal Layer 2

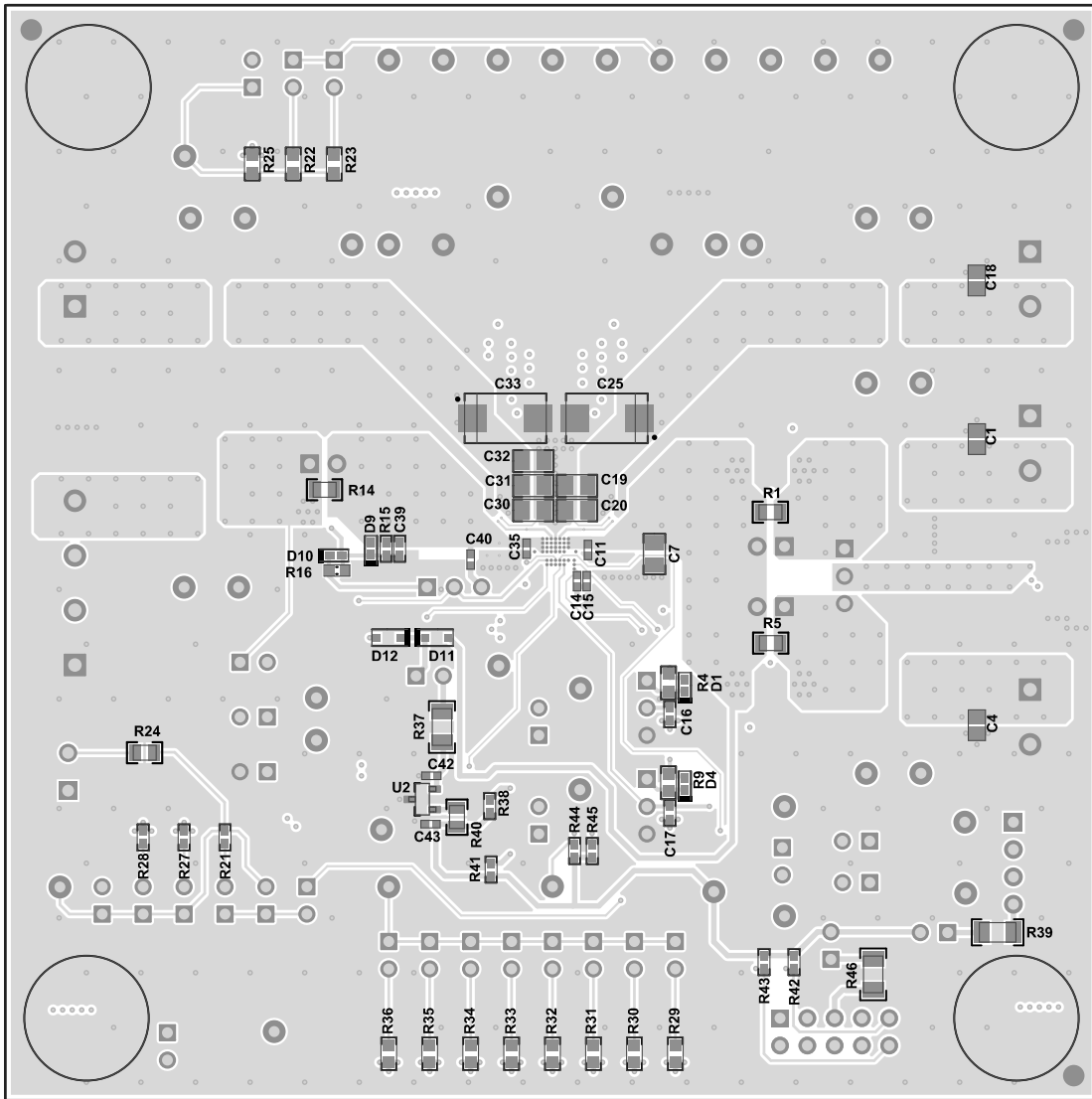

Figure 4-4. BMS027A Bottom Layer and Overlay

4.2 Schematic

Figure 4-5 through Figure 4-6 illustrate the schematic for the BQ25790EVM.

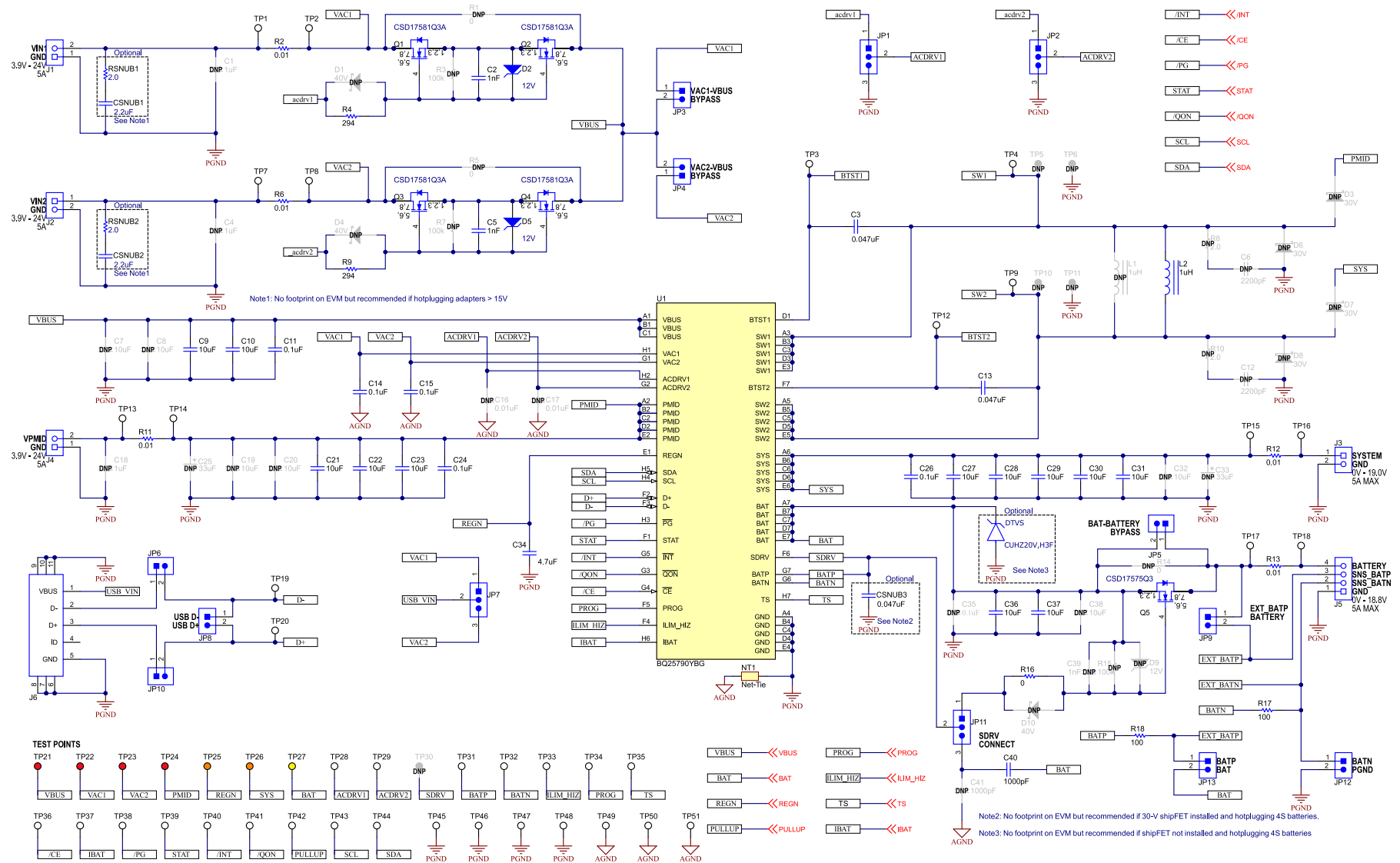

Figure 4-5. BQ25790EVM Schematic Page 1

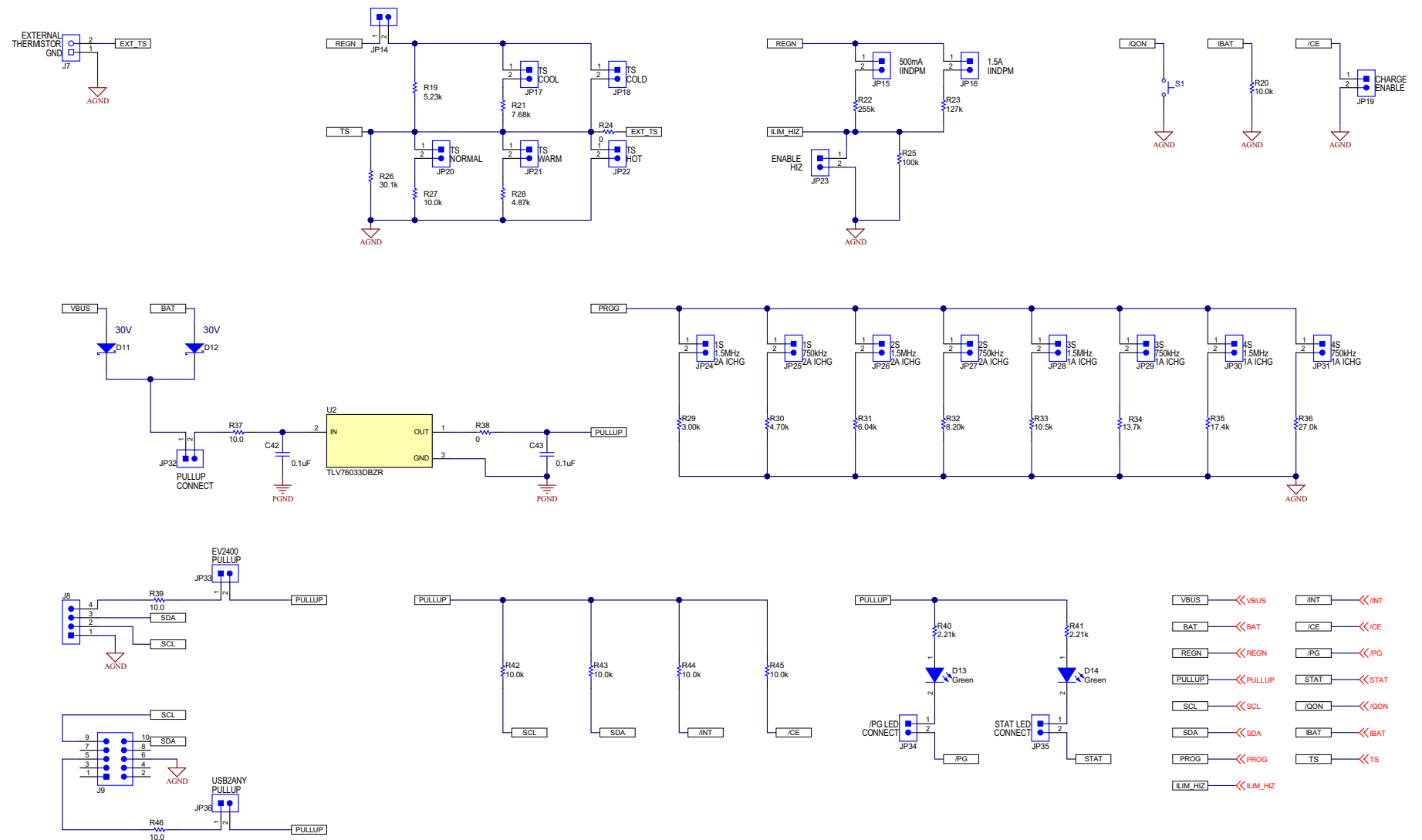

Figure 4-6. BQ25790EVM Schematic Page 2

4.3 Bill of Materials

The bill of materials is listed in [Table 4-1](#).

Table 4-1. BMS027A Bill of Materials

Designator	Quantity	Value	Description	Package Reference	Part Number	Manufacturer
C2, C5	2	1000pF	CAP, CERM, 1000 pF, 50 V, +/- 1%, C0G/NP0, 0402	0402	GRM1555C1H102FA01D	MuRata
C3, C13	2	0.047μF	CAP, CERM, 0.047 uF, 25 V, +/- 10%, X7R, 0402	0402	GRM155R71E473KA88D	MuRata
C9, C10, C21, C22, C23, C27, C28, C29, C30, C31	10	10μF	CAP, CERM, 10 uF, 25 V, +/- 10%, X5R, 0805	0805	C2012X5R1E106K125AB	TDK
C14, C15, C24, C26	4	0.1μF	CAP, CERM, 0.1 uF, 50 V, +/- 10%, X7R, 0402	0402	C1005X7R1H104K050BE	TDK
C34	1	4.7μF	CAP, CERM, 4.7 uF, 16 V, +/- 10%, X5R, 0603	0603	GRM188R61C475KAAJD	MuRata
C36, C37	2	10μF	CAP, CERM, 10 uF, 25 V, +/- 20%, X5R, 0603	0603	GRT188R61E106ME13D	MuRata
C41, C42	2	0.1μF	CAP, CERM, 0.1 uF, 25 V, +/- 10%, X5R, 0402	0402	GRM155R61E104KA87D	MuRata
D2, D5	2	12V	Diode, Zener, 12 V, 300 mW, SOD-523	SOD-523	BZT52C12T-7	Diodes Inc.
D11, D12	2	30V	Diode, Schottky, 30 V, 0.2 A, SOD-323	SOD-323	BAT54HT1G	ON Semiconductor
D13, D14	2	Green	LED, Green, SMD	1.6x0.8x0.8mm	LTST-C190GKT	Lite-On
H1, H2, H3, H4	4		Bumpon, Hemisphere, 0.44 X 0.20, Clear	Transparent Bumpon	SJ-5303 (CLEAR)	3M
J1, J2, J3, J4	4		Terminal Block, 5.08 mm, 2x1, Brass, TH	2x1 5.08 mm Terminal Block	ED120/2DS	On-Shore Technology
J5	1		Terminal Block, 5.08 mm, 4x1, Brass, TH	4x1 5.08 mm Terminal Block	ED120/4DS	On-Shore Technology
J6	1		Connector, Receptacle, Micro-USB Type B, R/A, Bottom Mount SMT	7.5x2.45x5mm	0473460001	Molex
J7	1		Terminal Block, 3.5 mm, 2x1, Tin, TH	Terminal Block, 3.5 mm, 2x1, TH	0393570002	Molex
J8	1		Header (friction lock), 100mil, 4x1, R/A, TH	4x1 R/A Header	0022053041	Molex
J9	1		Header (shrouded), 100mil, 5x2, High-Temperature, Gold, TH	5x2 Shrouded header	N2510-6002-RB	3M
JP1, JP2, JP7	3		Header, 100mil, 3x1, Tin, TH	Header, 3 PIN, 100mil, Tin	PEC03SAAN	Sullins Connector Solutions
JP3, JP4, JP5	3		Header, 100mil, 2x1, Gold, TH	Header, 100mil, 2x1, TH	HTSW-102-07-G-S	Samtec

Table 4-1. BMS027A Bill of Materials (continued)

Designator	Quantity	Value	Description	Package Reference	Part Number	Manufacturer
JP6, JP8, JP9, JP10, JP11, JP12, JP13, JP14, JP15, JP16, JP17, JP18, JP19, JP20, JP21, JP22, JP23, JP24, JP25, JP26, JP27, JP28, JP29, JP30, JP31, JP32, JP33, JP34, JP35, JP36	30		Header, 100mil, 2x1, Tin, TH	Header, 2 PIN, 100mil, Tin	PEC02SAAN	Sullins Connector Solutions
L2	1	1 μ H	Inductor, Shielded, Ferrite, 1 uH, 11.1 A, 0.0078 ohm, SMD	SMD 7.1x3.0x6.5mm	SPM6530T-1R0M120	TDK
Q1, Q2, Q3, Q4	4	30V	MOSFET, N-CH, 30 V, 60 A, DNH0008A (VSONP-8)	DNH0008A	CSD17581Q3A	Texas Instruments
Q5	1	30V	MOSFET, N-CH, 30 V, 60 A, DQG0008A (VSON-CLIP-8)	DQG0008A	CSD17575Q3	Texas Instruments
R2, R6, R11, R12, R13	5	0.01	RES, 0.01, 1%, 1 W, 2010	2010	WSL2010R0100FEA18	Vishay-Dale
R4, R9	2	294	RES, 294, 1%, 0.1 W, AEC-Q200 Grade 0, 0603	0603	CRCW0603294RFKEA	Vishay-Dale
R16	1	0	RES, 0, 5%, 0.1 W, AEC-Q200 Grade 0, 0603	0603	CRCW06030000Z0EA	Vishay-Dale
R17, R18	2	100	RES, 100, 1%, 0.1 W, 0603	0603	RC0603FR-07100RL	Yageo
R19	1	5.23k	RES, 5.23 k, 1%, 0.063 W, AEC-Q200 Grade 0, 0402	0402	CRCW04025K23FKED	Vishay-Dale
R20, R27, R41, R42, R43, R44	6	10.0k	RES, 10.0 k, 1%, 0.063 W, AEC-Q200 Grade 0, 0402	0402	CRCW040210K0FKED	Vishay-Dale
R21	1	7.68k	RES, 7.68 k, 1%, 0.063 W, AEC-Q200 Grade 0, 0402	0402	CRCW04027K68FKED	Vishay-Dale
R22	1	255k	RES, 255 k, 1%, 0.1 W, AEC-Q200 Grade 0, 0603	0603	CRCW0603255KFKEA	Vishay-Dale
R23	1	127k	RES, 127 k, 1%, 0.1 W, AEC-Q200 Grade 0, 0603	0603	CRCW0603127KFKEA	Vishay-Dale
R24	1	0	RES, 0, 1%, 0.5 W, 0805	0805	5106	Keystone
R25	1	100k	RES, 100 k, 1%, 0.1 W, 0603	0603	RC0603FR-07100KL	Yageo
R26	1	30.1k	RES, 30.1 k, 1%, 0.063 W, AEC-Q200 Grade 0, 0402	0402	CRCW040230K1FKED	Vishay-Dale
R28	1	4.87k	RES, 4.87 k, 1%, 0.063 W, AEC-Q200 Grade 0, 0402	0402	CRCW04024K87FKED	Vishay-Dale
R29	1	3.00k	RES, 3.00 k, 1%, 0.1 W, 0603	0603	RC0603FR-073KL	Yageo
R30	1	4.70k	RES, 4.70 k, 1%, 0.1 W, 0603	0603	RC0603FR-074K7L	Yageo
R31	1	6.04k	RES, 6.04 k, 1%, 0.1 W, 0603	0603	RC0603FR-076K04L	Yageo
R32	1	8.20k	RES, 8.20 k, 1%, 0.1 W, 0603	0603	RC0603FR-078K2L	Yageo
R33	1	10.5k	RES, 10.5 k, 1%, 0.1 W, AEC-Q200 Grade 0, 0603	0603	CRCW060310K5FKEA	Vishay-Dale
R34	1	13.7k	RES, 13.7 k, 1%, 0.1 W, AEC-Q200 Grade 0, 0603	0603	CRCW060313K7FKEA	Vishay-Dale
R35	1	17.4k	RES, 17.4 k, 1%, 0.1 W, 0603	0603	RC0603FR-0717K4L	Yageo
R36	1	27.0k	RES, 27.0 k, 1%, 0.1 W, AEC-Q200 Grade 0, 0603	0603	ERJ-3EKF2702V	Panasonic

Table 4-1. BMS027A Bill of Materials (continued)

Designator	Quantity	Value	Description	Package Reference	Part Number	Manufacturer
R37, R38, R45	3	10.0	RES, 10.0, 1%, 0.25 W, AEC-Q200 Grade 0, 1206	1206	ERJ-8ENF10R0V	Panasonic
R39, R40	2	2.21k	RES, 2.21 k, 1%, 0.063 W, AEC-Q200 Grade 0, 0402	0402	CRCW04022K21FKED	Vishay-Dale
S1	1		Switch, Normally open, 2.3N force, 200k operations, SMD	KSR	KSR221GLFS	C&K Components
SH-JP1, SH-JP2, SH-JP6, SH-JP7, SH-JP9, SH-JP10, SH-JP11, SH-JP12, SH-JP14, SH-JP16, SH-JP19, SH-JP20, SH-JP26, SH-JP32, SH-JP34, SH-JP35	16	1x2	Shunt, 100mil, Gold plated, Black	Shunt	SNT-100-BK-G	Samtec
TP1, TP2, TP3, TP6, TP7, TP10, TP11, TP12, TP13, TP14, TP15, TP16, TP17, TP18, TP26, TP27, TP28, TP29, TP30, TP31, TP32, TP33, TP34, TP35, TP36, TP37, TP38, TP39, TP40, TP41, TP42	31		Test Point, Miniature, White, TH	White Miniature Testpoint	5002	Keystone
TP19, TP20, TP21, TP22	4		Test Point, Miniature, Red, TH	Red Miniature Testpoint	5000	Keystone
TP23, TP24	2		Test Point, Miniature, Orange, TH	Orange Miniature Testpoint	5003	Keystone
TP25	1		Test Point, Miniature, Yellow, TH	Yellow Miniature Testpoint	5004	Keystone
TP43, TP44, TP45, TP46, TP47, TP48	6		Test Point, Compact, SMT	Testpoint_Keystone_Compact	5016	Keystone
U1	1		BQ25790, PREYBG0056 (DSBGA-56)	PREYBG0056	BQ25790YBG	Texas Instruments
U2	1		100 mA, Quasi Low-Dropout Linear Voltage Regulator, 3-pin SOT-23, Pb-Free	DBZ0003A	LM3480IM3-3.3/NOPB	Texas Instruments
C1, C4, C18	0	1 μ F	CAP, CERM, 1 uF, 25 V, +/- 10%, X7R, 0805	0805	GRM219R71E105KA88D	MuRata
C6, C12	0	2200pF	CAP, CERM, 2200 pF, 50 V, +/- 5%, C0G/NP0, 0603	0603	GRM1885C1H222JA01D	MuRata
C7, C8, C19, C20, C32	0	10 μ F	CAP, CERM, 10 uF, 25 V, +/- 10%, X5R, 0805	0805	C2012X5R1E106K125AB	TDK
C11, C39	0	1000pF	CAP, CERM, 1000 pF, 50 V, +/- 5%, C0G/NP0, 0402	0402	GRM1555C1H102JA01D	MuRata
C16, C17	0	0.01 μ F	CAP, CERM, 0.01 uF, 50 V, +/- 5%, X7R, 0402	0402	C0402C103J5RACTU	Kemet
C25, C33	0	33 μ F	CAP, TA, 33 uF, 35 V, +/- 20%, 0.065 ohm, SMD	7343-31	T521D336M035ATE065	Kemet
C35	0	0.1 μ F	CAP, CERM, 0.1 uF, 25 V, +/- 10%, X5R, 0402	0402	GRM155R61E104KA87D	MuRata
C38	0	10 μ F	CAP, CERM, 10 uF, 25 V, +/- 20%, X5R, 0603	0603	GRT188R61E106ME13D	MuRata

Table 4-1. BMS027A Bill of Materials (continued)

Designator	Quantity	Value	Description	Package Reference	Part Number	Manufacturer
C40	0	1000pF	CAP, CERM, 1000 pF, 50 V, +/- 1%, C0G/NP0, 0402	0402	GRM1555C1H102FA01D	MuRata
D1, D4, D10	0	40V	Diode, Schottky, 40 V, 0.38 A, SOD-523	SOD-523	ZLLS350TA	Diodes Inc.
D3, D6, D7, D8	0	30V	Diode, Schottky, 30 V, 1 A, SOD-123	SOD-123	B130LAW-7-F	Diodes Inc.
D9	0	12V	Diode, Zener, 12 V, 300 mW, SOD-523	SOD-523	BZT52C12T-7	Diodes Inc.
FID1, FID2, FID3, FID4, FID5, FID6	0		Fiducial mark. There is nothing to buy or mount.	N/A	N/A	N/A
L1	0	1μH	Inductor, 1 uH, 3.2 A, 0.028 ohm, SMD	2.5x2mm	MPIM252010F1R0M-LF	Microgate
R1, R5, R14	0	0	RES, 0, 1%, 0.5 W, 0805	0805	5106	Keystone
R3, R7, R15	0	100k	RES, 100 k, 1%, 0.0625 W, 0402	0402	RC0402FR-07100KL	Yageo America
R8, R10	0	2.0	RES, 2.0, 5%, 0.1 W, AEC-Q200 Grade 0, 0603	0603	CRCW06032R00JNEA	Vishay-Dale
SH-JP3, SH-JP4, SH- JP5, SH-JP8, SH- JP13, SH-JP15, SH- JP17, SH-JP18, SH- JP21, SH-JP22, SH- JP23, SH-JP24, SH- JP25, SH-JP27, SH- JP28, SH-JP29, SH- JP30, SH-JP31, SH- JP33, SH-JP36	0	1x2	Shunt, 100mil, Gold plated, Black	Shunt	SNT-100-BK-G	Samtec
TP4, TP5, TP8, TP9	0		Test Point, Miniature, White, TH	White Miniature Testpoint	5002	Keystone

5 Revision History

NOTE: Page numbers for previous revisions may differ from page numbers in the current version.

Changes from Revision B (March 2022) to Revision C (July 2022)	Page
• Changed Equipment section.....	6
• Changed Figure 2-1	6
• Added section about using a USB2ANY device. Changed section on BQStudio to tell the user to change input boxes instead of putting in binary numbers into the register window.....	8
• Changed Communication Verification section.....	8
• Changed Charge Mode Verification section.....	10
• Changed OTG Mode Verification section.....	11

Changes from Revision A (July 2020) to Revision B (March 2022)	Page
• Changed TP45 to TP47 in step 3 in Section 2.2	6
• Changed JP18 to JP19 in step 2 in Section 2.4.1	7

Changes from Revision * (June 2020) to Revision A (July 2020)	Page
• Changed Figure 2-1	6
• Changed Figure 4-5	18
• Changed Table 4-1	20

STANDARD TERMS FOR EVALUATION MODULES

1. *Delivery:* TI delivers TI evaluation boards, kits, or modules, including any accompanying demonstration software, components, and/or documentation which may be provided together or separately (collectively, an "EVM" or "EVMs") to the User ("User") in accordance with the terms set forth herein. User's acceptance of the EVM is expressly subject to the following terms.
 - 1.1 EVMs are intended solely for product or software developers for use in a research and development setting to facilitate feasibility evaluation, experimentation, or scientific analysis of TI semiconductors products. EVMs have no direct function and are not finished products. EVMs shall not be directly or indirectly assembled as a part or subassembly in any finished product. For clarification, any software or software tools provided with the EVM ("Software") shall not be subject to the terms and conditions set forth herein but rather shall be subject to the applicable terms that accompany such Software
 - 1.2 EVMs are not intended for consumer or household use. EVMs may not be sold, sublicensed, leased, rented, loaned, assigned, or otherwise distributed for commercial purposes by Users, in whole or in part, or used in any finished product or production system.
2. *Limited Warranty and Related Remedies/Disclaimers:*
 - 2.1 These terms do not apply to Software. The warranty, if any, for Software is covered in the applicable Software License Agreement.
 - 2.2 TI warrants that the TI EVM will conform to TI's published specifications for ninety (90) days after the date TI delivers such EVM to User. Notwithstanding the foregoing, TI shall not be liable for a nonconforming EVM if (a) the nonconformity was caused by neglect, misuse or mistreatment by an entity other than TI, including improper installation or testing, or for any EVMs that have been altered or modified in any way by an entity other than TI, (b) the nonconformity resulted from User's design, specifications or instructions for such EVMs or improper system design, or (c) User has not paid on time. Testing and other quality control techniques are used to the extent TI deems necessary. TI does not test all parameters of each EVM. User's claims against TI under this Section 2 are void if User fails to notify TI of any apparent defects in the EVMs within ten (10) business days after delivery, or of any hidden defects with ten (10) business days after the defect has been detected.
 - 2.3 TI's sole liability shall be at its option to repair or replace EVMs that fail to conform to the warranty set forth above, or credit User's account for such EVM. TI's liability under this warranty shall be limited to EVMs that are returned during the warranty period to the address designated by TI and that are determined by TI not to conform to such warranty. If TI elects to repair or replace such EVM, TI shall have a reasonable time to repair such EVM or provide replacements. Repaired EVMs shall be warranted for the remainder of the original warranty period. Replaced EVMs shall be warranted for a new full ninety (90) day warranty period.

WARNING

Evaluation Kits are intended solely for use by technically qualified, professional electronics experts who are familiar with the dangers and application risks associated with handling electrical mechanical components, systems, and subsystems.

User shall operate the Evaluation Kit within TI's recommended guidelines and any applicable legal or environmental requirements as well as reasonable and customary safeguards. Failure to set up and/or operate the Evaluation Kit within TI's recommended guidelines may result in personal injury or death or property damage. Proper set up entails following TI's instructions for electrical ratings of interface circuits such as input, output and electrical loads.

NOTE:

EXPOSURE TO ELECTROSTATIC DISCHARGE (ESD) MAY CAUSE DEGRADATION OR FAILURE OF THE EVALUATION KIT; TI RECOMMENDS STORAGE OF THE EVALUATION KIT IN A PROTECTIVE ESD BAG.

3 Regulatory Notices:

3.1 United States

3.1.1 Notice applicable to EVMs not FCC-Approved:

FCC NOTICE: This kit is designed to allow product developers to evaluate electronic components, circuitry, or software associated with the kit to determine whether to incorporate such items in a finished product and software developers to write software applications for use with the end product. This kit is not a finished product and when assembled may not be resold or otherwise marketed unless all required FCC equipment authorizations are first obtained. Operation is subject to the condition that this product not cause harmful interference to licensed radio stations and that this product accept harmful interference. Unless the assembled kit is designed to operate under part 15, part 18 or part 95 of this chapter, the operator of the kit must operate under the authority of an FCC license holder or must secure an experimental authorization under part 5 of this chapter.

3.1.2 For EVMs annotated as FCC – FEDERAL COMMUNICATIONS COMMISSION Part 15 Compliant:

CAUTION

This device complies with part 15 of the FCC Rules. Operation is subject to the following two conditions: (1) This device may not cause harmful interference, and (2) this device must accept any interference received, including interference that may cause undesired operation.

Changes or modifications not expressly approved by the party responsible for compliance could void the user's authority to operate the equipment.

FCC Interference Statement for Class A EVM devices

NOTE: This equipment has been tested and found to comply with the limits for a Class A digital device, pursuant to part 15 of the FCC Rules. These limits are designed to provide reasonable protection against harmful interference when the equipment is operated in a commercial environment. This equipment generates, uses, and can radiate radio frequency energy and, if not installed and used in accordance with the instruction manual, may cause harmful interference to radio communications. Operation of this equipment in a residential area is likely to cause harmful interference in which case the user will be required to correct the interference at his own expense.

FCC Interference Statement for Class B EVM devices

NOTE: This equipment has been tested and found to comply with the limits for a Class B digital device, pursuant to part 15 of the FCC Rules. These limits are designed to provide reasonable protection against harmful interference in a residential installation. This equipment generates, uses and can radiate radio frequency energy and, if not installed and used in accordance with the instructions, may cause harmful interference to radio communications. However, there is no guarantee that interference will not occur in a particular installation. If this equipment does cause harmful interference to radio or television reception, which can be determined by turning the equipment off and on, the user is encouraged to try to correct the interference by one or more of the following measures:

- Reorient or relocate the receiving antenna.
- Increase the separation between the equipment and receiver.
- Connect the equipment into an outlet on a circuit different from that to which the receiver is connected.
- Consult the dealer or an experienced radio/TV technician for help.

3.2 Canada

3.2.1 For EVMs issued with an Industry Canada Certificate of Conformance to RSS-210 or RSS-247

Concerning EVMs Including Radio Transmitters:

This device complies with Industry Canada license-exempt RSSs. Operation is subject to the following two conditions:

(1) this device may not cause interference, and (2) this device must accept any interference, including interference that may cause undesired operation of the device.

Concernant les EVMs avec appareils radio:

Le présent appareil est conforme aux CNR d'Industrie Canada applicables aux appareils radio exempts de licence. L'exploitation est autorisée aux deux conditions suivantes: (1) l'appareil ne doit pas produire de brouillage, et (2) l'utilisateur de l'appareil doit accepter tout brouillage radioélectrique subi, même si le brouillage est susceptible d'en compromettre le fonctionnement.

Concerning EVMs Including Detachable Antennas:

Under Industry Canada regulations, this radio transmitter may only operate using an antenna of a type and maximum (or lesser) gain approved for the transmitter by Industry Canada. To reduce potential radio interference to other users, the antenna type and its gain should be so chosen that the equivalent isotropically radiated power (e.i.r.p.) is not more than that necessary for successful communication. This radio transmitter has been approved by Industry Canada to operate with the antenna types listed in the user guide with the maximum permissible gain and required antenna impedance for each antenna type indicated. Antenna types not included in this list, having a gain greater than the maximum gain indicated for that type, are strictly prohibited for use with this device.

Concernant les EVMs avec antennes détachables

Conformément à la réglementation d'Industrie Canada, le présent émetteur radio peut fonctionner avec une antenne d'un type et d'un gain maximal (ou inférieur) approuvé pour l'émetteur par Industrie Canada. Dans le but de réduire les risques de brouillage radioélectrique à l'intention des autres utilisateurs, il faut choisir le type d'antenne et son gain de sorte que la puissance isotrope rayonnée équivalente (p.i.r.e.) ne dépasse pas l'intensité nécessaire à l'établissement d'une communication satisfaisante. Le présent émetteur radio a été approuvé par Industrie Canada pour fonctionner avec les types d'antenne énumérés dans le manuel d'usage et ayant un gain admissible maximal et l'impédance requise pour chaque type d'antenne. Les types d'antenne non inclus dans cette liste, ou dont le gain est supérieur au gain maximal indiqué, sont strictement interdits pour l'exploitation de l'émetteur.

3.3 Japan

3.3.1 *Notice for EVMs delivered in Japan:* Please see http://www.tij.co.jp/lstds/ti_ja/general/eStore/notice_01.page 日本国内に輸入される評価用キット、ボードについては、次のところをご覧ください。
http://www.tij.co.jp/lstds/ti_ja/general/eStore/notice_01.page

3.3.2 *Notice for Users of EVMs Considered "Radio Frequency Products" in Japan:* EVMs entering Japan may not be certified by TI as conforming to Technical Regulations of Radio Law of Japan.

If User uses EVMs in Japan, not certified to Technical Regulations of Radio Law of Japan, User is required to follow the instructions set forth by Radio Law of Japan, which includes, but is not limited to, the instructions below with respect to EVMs (which for the avoidance of doubt are stated strictly for convenience and should be verified by User):

1. Use EVMs in a shielded room or any other test facility as defined in the notification #173 issued by Ministry of Internal Affairs and Communications on March 28, 2006, based on Sub-section 1.1 of Article 6 of the Ministry's Rule for Enforcement of Radio Law of Japan,
2. Use EVMs only after User obtains the license of Test Radio Station as provided in Radio Law of Japan with respect to EVMs, or
3. Use of EVMs only after User obtains the Technical Regulations Conformity Certification as provided in Radio Law of Japan with respect to EVMs. Also, do not transfer EVMs, unless User gives the same notice above to the transferee. Please note that if User does not follow the instructions above, User will be subject to penalties of Radio Law of Japan.

【無線電波を送信する製品の開発キットをお使いになる際の注意事項】 開発キットの中には技術基準適合証明を受けていないものがあります。技術適合証明を受けていないものご使用に際しては、電波法遵守のため、以下のいずれかの措置を取っていただく必要がありますのでご注意ください。

1. 電波法施行規則第6条第1項第1号に基づく平成18年3月28日総務省告示第173号で定められた電波暗室等の試験設備でご使用いただく。
2. 実験局の免許を取得後ご使用いただく。
3. 技術基準適合証明を取得後ご使用いただく。

なお、本製品は、上記の「ご使用にあたっての注意」を譲渡先、移転先に通知しない限り、譲渡、移転できないものとします。

上記を遵守頂けない場合は、電波法の罰則が適用される可能性があることをご留意ください。日本テキサス・インスツルメンツ株式会社
東京都新宿区西新宿 6 丁目 2 4 番 1 号
西新宿三井ビル

3.3.3 *Notice for EVMs for Power Line Communication:* Please see http://www.tij.co.jp/lstds/ti_ja/general/eStore/notice_02.page
電力線搬送波通信についての開発キットをお使いになる際の注意事項については、次のところをご覧ください。http://www.tij.co.jp/lstds/ti_ja/general/eStore/notice_02.page

3.4 European Union

3.4.1 *For EVMs subject to EU Directive 2014/30/EU (Electromagnetic Compatibility Directive):*

This is a class A product intended for use in environments other than domestic environments that are connected to a low-voltage power-supply network that supplies buildings used for domestic purposes. In a domestic environment this product may cause radio interference in which case the user may be required to take adequate measures.

-
- 4 *EVM Use Restrictions and Warnings:*
 - 4.1 EVMS ARE NOT FOR USE IN FUNCTIONAL SAFETY AND/OR SAFETY CRITICAL EVALUATIONS, INCLUDING BUT NOT LIMITED TO EVALUATIONS OF LIFE SUPPORT APPLICATIONS.
 - 4.2 User must read and apply the user guide and other available documentation provided by TI regarding the EVM prior to handling or using the EVM, including without limitation any warning or restriction notices. The notices contain important safety information related to, for example, temperatures and voltages.
 - 4.3 *Safety-Related Warnings and Restrictions:*
 - 4.3.1 User shall operate the EVM within TI's recommended specifications and environmental considerations stated in the user guide, other available documentation provided by TI, and any other applicable requirements and employ reasonable and customary safeguards. Exceeding the specified performance ratings and specifications (including but not limited to input and output voltage, current, power, and environmental ranges) for the EVM may cause personal injury or death, or property damage. If there are questions concerning performance ratings and specifications, User should contact a TI field representative prior to connecting interface electronics including input power and intended loads. Any loads applied outside of the specified output range may also result in unintended and/or inaccurate operation and/or possible permanent damage to the EVM and/or interface electronics. Please consult the EVM user guide prior to connecting any load to the EVM output. If there is uncertainty as to the load specification, please contact a TI field representative. During normal operation, even with the inputs and outputs kept within the specified allowable ranges, some circuit components may have elevated case temperatures. These components include but are not limited to linear regulators, switching transistors, pass transistors, current sense resistors, and heat sinks, which can be identified using the information in the associated documentation. When working with the EVM, please be aware that the EVM may become very warm.
 - 4.3.2 EVMs are intended solely for use by technically qualified, professional electronics experts who are familiar with the dangers and application risks associated with handling electrical mechanical components, systems, and subsystems. User assumes all responsibility and liability for proper and safe handling and use of the EVM by User or its employees, affiliates, contractors or designees. User assumes all responsibility and liability to ensure that any interfaces (electronic and/or mechanical) between the EVM and any human body are designed with suitable isolation and means to safely limit accessible leakage currents to minimize the risk of electrical shock hazard. User assumes all responsibility and liability for any improper or unsafe handling or use of the EVM by User or its employees, affiliates, contractors or designees.
 - 4.4 User assumes all responsibility and liability to determine whether the EVM is subject to any applicable international, federal, state, or local laws and regulations related to User's handling and use of the EVM and, if applicable, User assumes all responsibility and liability for compliance in all respects with such laws and regulations. User assumes all responsibility and liability for proper disposal and recycling of the EVM consistent with all applicable international, federal, state, and local requirements.
 5. *Accuracy of Information:* To the extent TI provides information on the availability and function of EVMs, TI attempts to be as accurate as possible. However, TI does not warrant the accuracy of EVM descriptions, EVM availability or other information on its websites as accurate, complete, reliable, current, or error-free.
 6. *Disclaimers:*
 - 6.1 EXCEPT AS SET FORTH ABOVE, EVMS AND ANY MATERIALS PROVIDED WITH THE EVM (INCLUDING, BUT NOT LIMITED TO, REFERENCE DESIGNS AND THE DESIGN OF THE EVM ITSELF) ARE PROVIDED "AS IS" AND "WITH ALL FAULTS." TI DISCLAIMS ALL OTHER WARRANTIES, EXPRESS OR IMPLIED, REGARDING SUCH ITEMS, INCLUDING BUT NOT LIMITED TO ANY EPIDEMIC FAILURE WARRANTY OR IMPLIED WARRANTIES OF MERCHANTABILITY OR FITNESS FOR A PARTICULAR PURPOSE OR NON-INFRINGEMENT OF ANY THIRD PARTY PATENTS, COPYRIGHTS, TRADE SECRETS OR OTHER INTELLECTUAL PROPERTY RIGHTS.
 - 6.2 EXCEPT FOR THE LIMITED RIGHT TO USE THE EVM SET FORTH HEREIN, NOTHING IN THESE TERMS SHALL BE CONSTRUED AS GRANTING OR CONFERRING ANY RIGHTS BY LICENSE, PATENT, OR ANY OTHER INDUSTRIAL OR INTELLECTUAL PROPERTY RIGHT OF TI, ITS SUPPLIERS/LICENSORS OR ANY OTHER THIRD PARTY, TO USE THE EVM IN ANY FINISHED END-USER OR READY-TO-USE FINAL PRODUCT, OR FOR ANY INVENTION, DISCOVERY OR IMPROVEMENT, REGARDLESS OF WHEN MADE, CONCEIVED OR ACQUIRED.
 7. *USER'S INDEMNITY OBLIGATIONS AND REPRESENTATIONS.* USER WILL DEFEND, INDEMNIFY AND HOLD TI, ITS LICENSORS AND THEIR REPRESENTATIVES HARMLESS FROM AND AGAINST ANY AND ALL CLAIMS, DAMAGES, LOSSES, EXPENSES, COSTS AND LIABILITIES (COLLECTIVELY, "CLAIMS") ARISING OUT OF OR IN CONNECTION WITH ANY HANDLING OR USE OF THE EVM THAT IS NOT IN ACCORDANCE WITH THESE TERMS. THIS OBLIGATION SHALL APPLY WHETHER CLAIMS ARISE UNDER STATUTE, REGULATION, OR THE LAW OF TORT, CONTRACT OR ANY OTHER LEGAL THEORY, AND EVEN IF THE EVM FAILS TO PERFORM AS DESCRIBED OR EXPECTED.
-

8. *Limitations on Damages and Liability:*

8.1 *General Limitations.* IN NO EVENT SHALL TI BE LIABLE FOR ANY SPECIAL, COLLATERAL, INDIRECT, PUNITIVE, INCIDENTAL, CONSEQUENTIAL, OR EXEMPLARY DAMAGES IN CONNECTION WITH OR ARISING OUT OF THESE TERMS OR THE USE OF THE EVMS , REGARDLESS OF WHETHER TI HAS BEEN ADVISED OF THE POSSIBILITY OF SUCH DAMAGES. EXCLUDED DAMAGES INCLUDE, BUT ARE NOT LIMITED TO, COST OF REMOVAL OR REINSTALLATION, ANCILLARY COSTS TO THE PROCUREMENT OF SUBSTITUTE GOODS OR SERVICES, RETESTING, OUTSIDE COMPUTER TIME, LABOR COSTS, LOSS OF GOODWILL, LOSS OF PROFITS, LOSS OF SAVINGS, LOSS OF USE, LOSS OF DATA, OR BUSINESS INTERRUPTION. NO CLAIM, SUIT OR ACTION SHALL BE BROUGHT AGAINST TI MORE THAN TWELVE (12) MONTHS AFTER THE EVENT THAT GAVE RISE TO THE CAUSE OF ACTION HAS OCCURRED.

8.2 *Specific Limitations.* IN NO EVENT SHALL TI'S AGGREGATE LIABILITY FROM ANY USE OF AN EVM PROVIDED HEREUNDER, INCLUDING FROM ANY WARRANTY, INDEMNITY OR OTHER OBLIGATION ARISING OUT OF OR IN CONNECTION WITH THESE TERMS, , EXCEED THE TOTAL AMOUNT PAID TO TI BY USER FOR THE PARTICULAR EVM(S) AT ISSUE DURING THE PRIOR TWELVE (12) MONTHS WITH RESPECT TO WHICH LOSSES OR DAMAGES ARE CLAIMED. THE EXISTENCE OF MORE THAN ONE CLAIM SHALL NOT ENLARGE OR EXTEND THIS LIMIT.

9. *Return Policy.* Except as otherwise provided, TI does not offer any refunds, returns, or exchanges. Furthermore, no return of EVM(s) will be accepted if the package has been opened and no return of the EVM(s) will be accepted if they are damaged or otherwise not in a resalable condition. If User feels it has been incorrectly charged for the EVM(s) it ordered or that delivery violates the applicable order, User should contact TI. All refunds will be made in full within thirty (30) working days from the return of the components(s), excluding any postage or packaging costs.

10. *Governing Law:* These terms and conditions shall be governed by and interpreted in accordance with the laws of the State of Texas, without reference to conflict-of-laws principles. User agrees that non-exclusive jurisdiction for any dispute arising out of or relating to these terms and conditions lies within courts located in the State of Texas and consents to venue in Dallas County, Texas. Notwithstanding the foregoing, any judgment may be enforced in any United States or foreign court, and TI may seek injunctive relief in any United States or foreign court.

Mailing Address: Texas Instruments, Post Office Box 655303, Dallas, Texas 75265
Copyright © 2019, Texas Instruments Incorporated

IMPORTANT NOTICE AND DISCLAIMER

TI PROVIDES TECHNICAL AND RELIABILITY DATA (INCLUDING DATA SHEETS), DESIGN RESOURCES (INCLUDING REFERENCE DESIGNS), APPLICATION OR OTHER DESIGN ADVICE, WEB TOOLS, SAFETY INFORMATION, AND OTHER RESOURCES "AS IS" AND WITH ALL FAULTS, AND DISCLAIMS ALL WARRANTIES, EXPRESS AND IMPLIED, INCLUDING WITHOUT LIMITATION ANY IMPLIED WARRANTIES OF MERCHANTABILITY, FITNESS FOR A PARTICULAR PURPOSE OR NON-INFRINGEMENT OF THIRD PARTY INTELLECTUAL PROPERTY RIGHTS.

These resources are intended for skilled developers designing with TI products. You are solely responsible for (1) selecting the appropriate TI products for your application, (2) designing, validating and testing your application, and (3) ensuring your application meets applicable standards, and any other safety, security, regulatory or other requirements.

These resources are subject to change without notice. TI grants you permission to use these resources only for development of an application that uses the TI products described in the resource. Other reproduction and display of these resources is prohibited. No license is granted to any other TI intellectual property right or to any third party intellectual property right. TI disclaims responsibility for, and you will fully indemnify TI and its representatives against, any claims, damages, costs, losses, and liabilities arising out of your use of these resources.

TI's products are provided subject to [TI's Terms of Sale](#) or other applicable terms available either on ti.com or provided in conjunction with such TI products. TI's provision of these resources does not expand or otherwise alter TI's applicable warranties or warranty disclaimers for TI products.

TI objects to and rejects any additional or different terms you may have proposed.

Mailing Address: Texas Instruments, Post Office Box 655303, Dallas, Texas 75265
Copyright © 2022, Texas Instruments Incorporated