

DO NOT SCALE FROM THIS PRINT

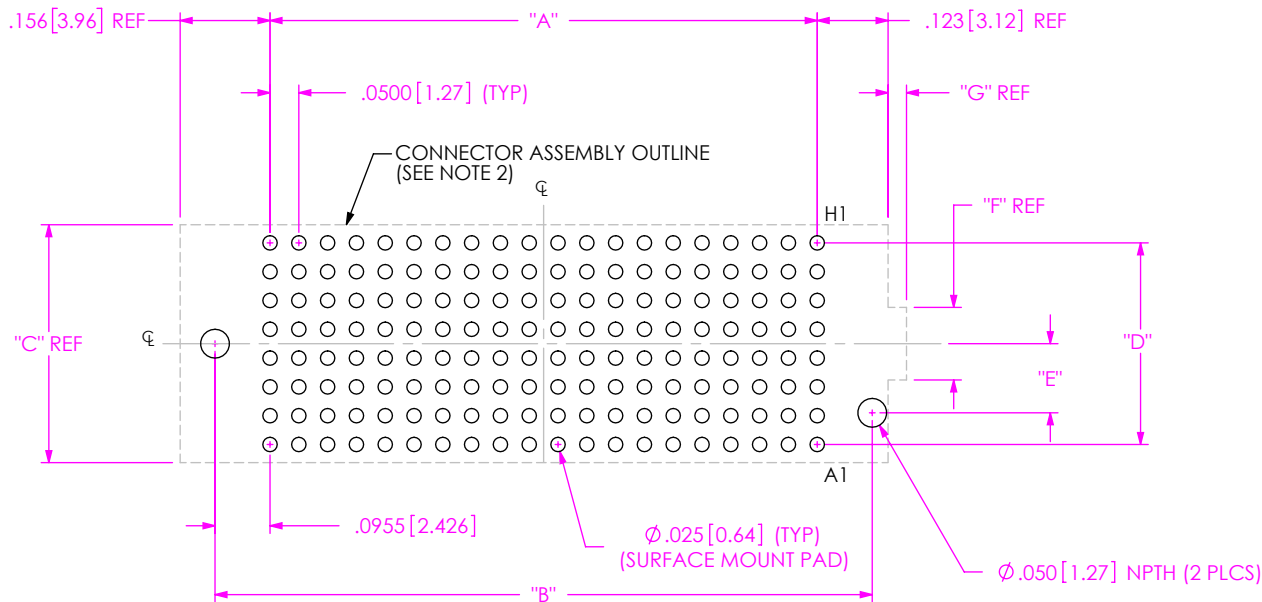

FIG 1  
FOOTPRINT FOR SEAF-20-XX.X-XX-08-X-A AND SEAFc-20-XX.X-X-08-X-X SHOWN

TABLE 1

No. OF POS	"A"	"B"
-10	.450 [11.43]	.641 [16.28]
-15	.700 [17.78]	.891 [22.63]
-19	.900 [22.86]	1.091 [27.71]
-20	.950 [24.13]	1.141 [28.98]
-25	1.200 [30.48]	1.391 [35.33]
-30	1.450 [36.83]	1.641 [41.68]
-40	1.950 [49.53]	2.141 [54.38]
-50	2.450 [62.23]	2.641 [67.08]

TABLE 2

ROW	"C"	"D"	"E"	"F"	"G"
-04	.223 [5.66]	.150 [3.81]	.079 [2.01]	.126 [3.20]	.053 [1.35]
-05	.323 [8.20]	.200 [5.08]	.120 [3.05]	.224 [5.69]	.033 [0.84]
-06	.323 [8.20]	.250 [6.35]	.120 [3.05]	.224 [5.69]	.033 [0.84]
-08	.423 [10.74]	.350 [8.89]	.120 [3.05]	.126 [3.20]	.033 [0.84]
-10	.523 [13.28]	.450 [11.43]	.120 [3.05]	.224 [5.69]	.033 [0.84]
-14	.723 [18.36]	.650 [16.51]	.120 [3.05]	.224 [5.69]	.033 [0.84]

NOTES:

1. ALL DIMENSIONS ARE SYMMETRIC ABOUT THE CENTERLINE.
2. CONNECTOR ENVELOPE DIMENSIONS, OTHER COMPONENTS PLACED ON PCB SHALL AVOID THIS ZONE.
3. SEE SUBSEQUENT SHEETS FOR STENCIL REQUIREMENTS.

PROPRIETARY NOTE

THIS DOCUMENT CONTAINS CONFIDENTIAL AND PROPRIETARY INFORMATION AND ALL DESIGN, MANUFACTURING, REPRODUCTION, USE, PATENT RIGHTS AND SALES RIGHTS ARE EXPRESSLY RESERVED BY SAMTEC, INC. THIS DOCUMENT SHALL NOT BE DISCLOSED, IN WHOLE OR PART, TO ANY UNAUTHORIZED PERSON OR ENTITY NOR REPRODUCED, TRANSFERRED OR INCORPORATED IN ANY OTHER PROJECT IN ANY MANNER WITHOUT THE EXPRESS WRITTEN CONSENT OF SAMTEC, INC.



520 PARK EAST BLVD, NEW ALBANY, IN 47150  
PHONE: 812-944-6733 FAX: 812-948-5047  
e-Mail info@SAMTEC.com code 55322



NOTE:  
STENCIL TO BE .0060[0.152] THICK.

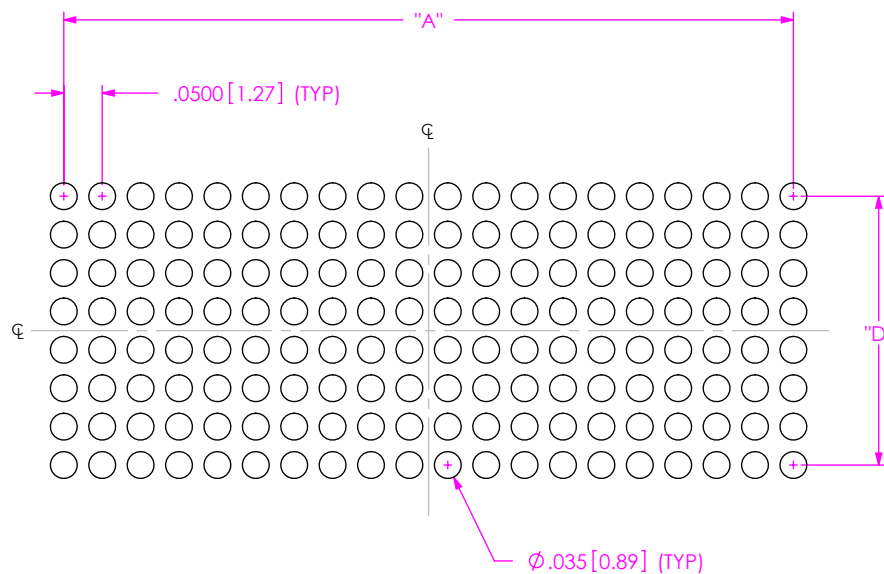

FIG 2  
STENCIL FOR SEAF-20-XX.X-XX-08-X-A AND SE AFC-20-XX.X-XX-08-X-X SHOWN (ALL DIMENSIONS ARE SYMMETRIC ABOUT THE CENTERLINE.)

**PROPRIETARY NOTE**  
THIS DOCUMENT CONTAINS CONFIDENTIAL AND PROPRIETARY INFORMATION AND ALL DESIGN, MANUFACTURING, REPRODUCTION, USE, PATENT RIGHTS AND SALES RIGHTS ARE EXPRESSLY RESERVED BY SAMTEC, INC. THIS DOCUMENT SHALL NOT BE DISCLOSED, IN WHOLE OR PART, TO ANY UNAUTHORIZED PERSON OR ENTITY NOR REPRODUCED, TRANSFERRED OR INCORPORATED IN ANY OTHER PROJECT IN ANY MANNER WITHOUT THE EXPRESS WRITTEN CONSENT OF SAMTEC, INC.



520 PARK EAST BLVD, NEW ALBANY, IN 47150  
PHONE: 812-944-6733 FAX: 812-948-5047  
e-Mail info@SAMTEC.com code 55322

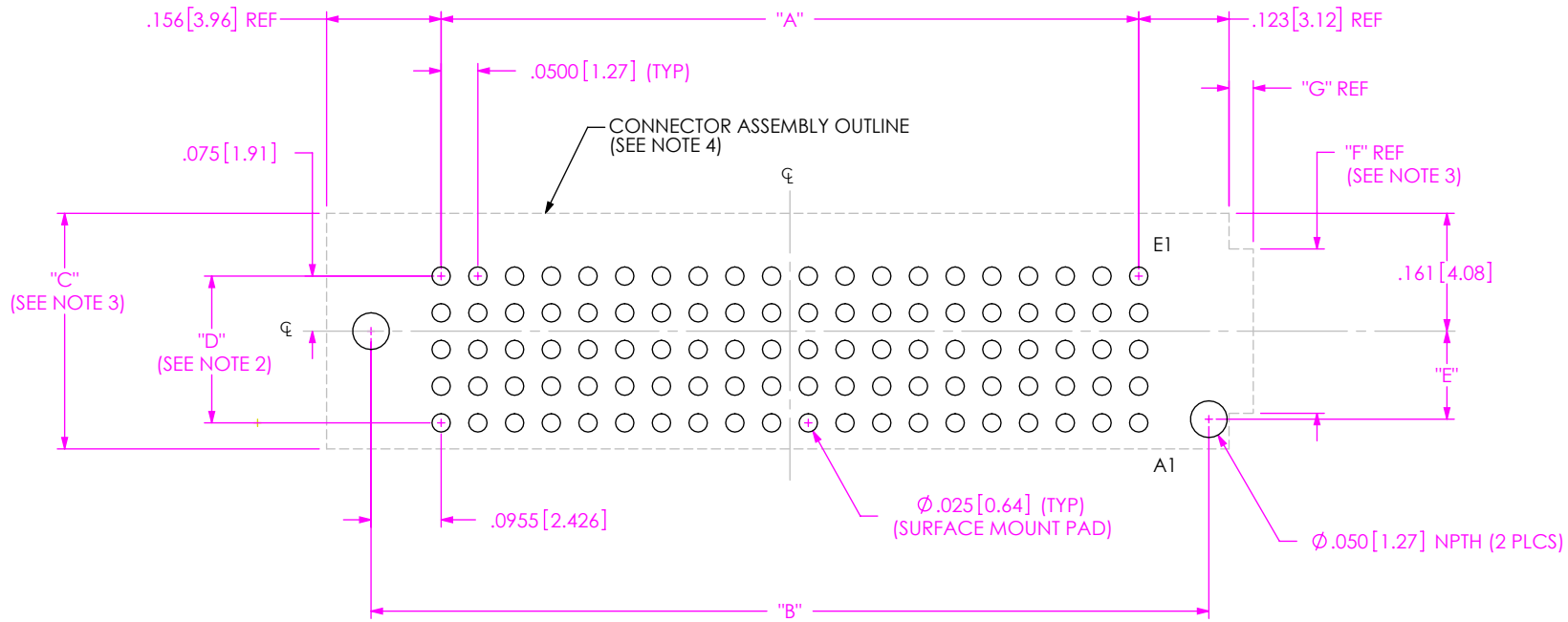

FIG 3  
FOOTPRINT FOR SEAF-20-XX.X-XX-05-X-A AND SEAF-20-XX.X-X-05-X-X SHOWN



- NOTES:
1. ALL DIMENSIONS ARE SYMMETRIC ABOUT THE VERTICAL CENTERLINE ONLY.
  2. PADS ARE NOT SYMMETRIC ABOUT HORIZONTAL CENTERLINE.
  3. CONNECTOR OUTLINE IS SYMMETRIC ABOUT CENTERLINE.
  4. CONNECTOR ENVELOPE DIMENSIONS, OTHER COMPONENTS PLACED ON THE PCB SHALL AVOID THIS ZONE.

• PROPRIETARY NOTE •  
THIS DOCUMENT CONTAINS CONFIDENTIAL AND PROPRIETARY INFORMATION AND ALL DESIGN, MANUFACTURING, REPRODUCTION, USE, PATENT RIGHTS AND SALES RIGHTS ARE EXPRESSLY RESERVED BY SAMTEC, INC. THIS DOCUMENT SHALL NOT BE DISCLOSED, IN WHOLE OR PART, TO ANY UNAUTHORIZED PERSON OR ENTITY NOR REPRODUCED, TRANSFERRED OR INCORPORATED IN ANY OTHER PROJECT IN ANY MANNER WITHOUT THE EXPRESS WRITTEN CONSENT OF SAMTEC, INC.



520 PARK EAST BLVD, NEW ALBANY, IN 47150  
PHONE: 812-944-6733 FAX: 812-948-5047  
e-Mail info@SAMTEC.com code 55322

X

NOTE:  
STENCIL TO BE .0060[0.152] THICK.

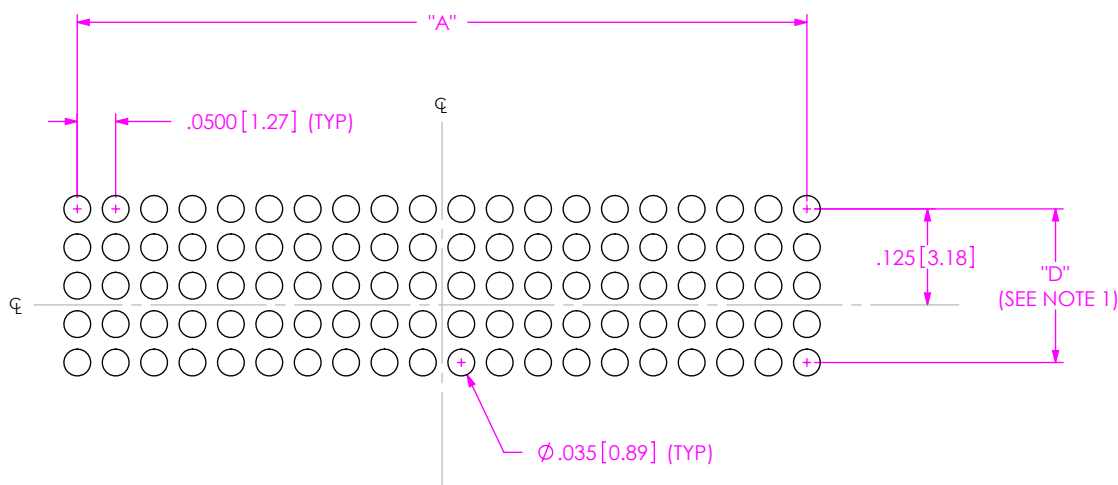

FIG 4  
STENCIL FOR SEAF-20-XX.X-XX-05-X-A AND SE AFC-20-XX.X-X-05-X-X SHOWN (ALL DIMENSIONS ARE SYMMETRIC ABOUT THE VERTICAL CENTERLINE ONLY.) X

NOTES:  
1. PADS ARE NOT SYMMETRIC ABOUT HORIZONTAL CENTERLINE.

**PROPRIETARY NOTE**  
THIS DOCUMENT CONTAINS CONFIDENTIAL AND PROPRIETARY INFORMATION AND ALL DESIGN, MANUFACTURING, REPRODUCTION, USE, PATENT RIGHTS AND SALES RIGHTS ARE EXPRESSLY RESERVED BY SAMTEC, INC. THIS DOCUMENT SHALL NOT BE DISCLOSED, IN WHOLE OR PART, TO ANY UNAUTHORIZED PERSON OR ENTITY NOR REPRODUCED, TRANSFERRED OR INCORPORATED IN ANY OTHER PROJECT IN ANY MANNER WITHOUT THE EXPRESS WRITTEN CONSENT OF SAMTEC, INC.



520 PARK EAST BLVD., NEW ALBANY, IN 47150  
PHONE: 812-944-6733 FAX: 812-948-5047  
e-Mail info@SAMTEC.com code 55322

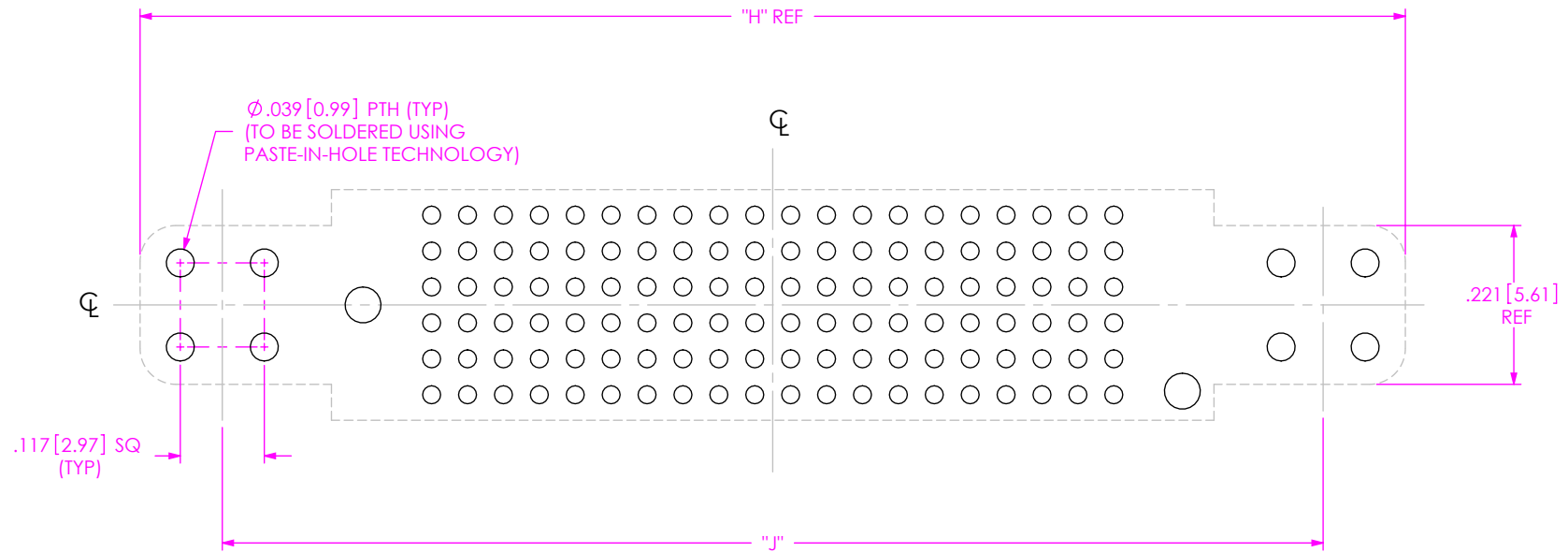

FIG 5  
-LP & -PP OPTION  
FOOTPRINT FOR SEAF-20-XX.X-XX-06-X-A-LP AND SEAF-20-XX.X-XX-06-X SHOWN  
(SAME AS FIG 1, EXCEPT AS SHOWN)

TABLE 3

No. OF POS	"H"	"J"
-10	1.262 [32.05]	1.033 [26.24]
-15	1.512 [38.40]	1.283 [32.59]
-19	1.712 [43.48]	1.483 [37.67]
-20	1.762 [44.75]	1.533 [38.94]
-25	2.012 [51.10]	1.783 [45.29]
-30	2.262 [57.45]	2.033 [51.64]
-40	2.762 [70.15]	2.533 [64.34]
-50	3.262 [82.85]	3.033 [77.04]

PROPRIETARY NOTE  
THIS DOCUMENT CONTAINS CONFIDENTIAL AND PROPRIETARY INFORMATION AND ALL DESIGN, MANUFACTURING, REPRODUCTION, USE, PATENT RIGHTS AND SALES RIGHTS ARE EXPRESSLY RESERVED BY SAMTEC, INC. THIS DOCUMENT SHALL NOT BE DISCLOSED, IN WHOLE OR PART, TO ANY UNAUTHORIZED PERSON OR ENTITY NOR REPRODUCED, TRANSFERRED OR INCORPORATED IN ANY OTHER PROJECT IN ANY MANNER WITHOUT THE EXPRESS WRITTEN CONSENT OF SAMTEC, INC.



520 PARK EAST BLVD, NEW ALBANY, IN 47150  
PHONE: 812-944-6733 FAX: 812-948-5047  
e-Mail info@SAMTEC.com code 55322

X

NOTE:  
STENCIL TO BE .0060[0.152] THICK.

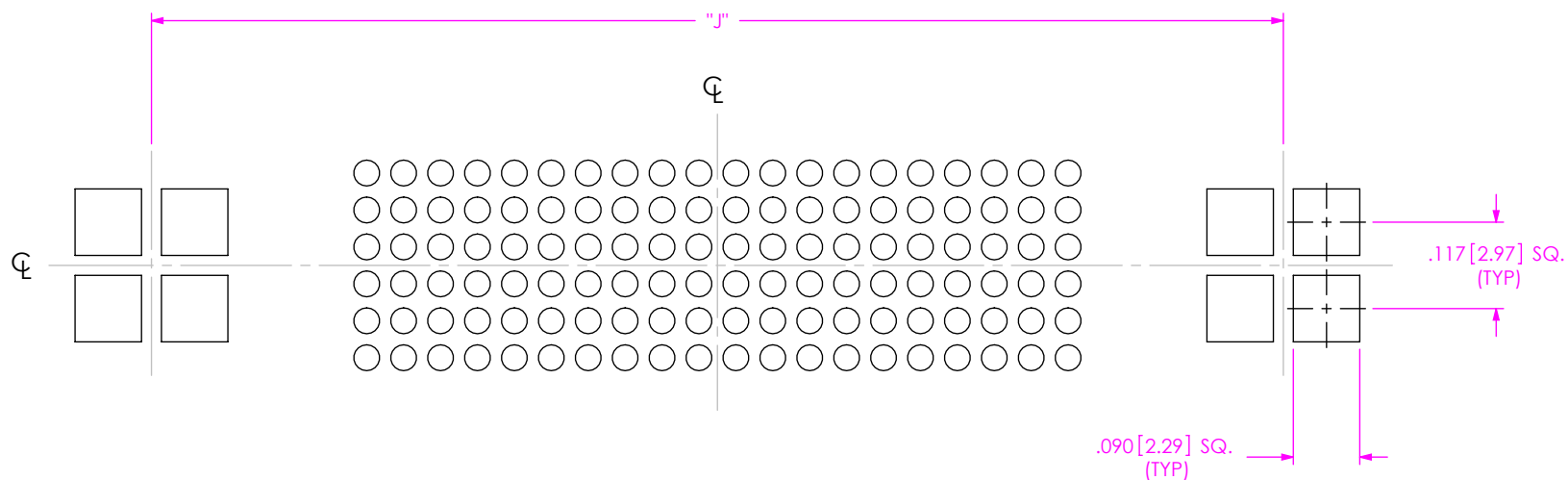

FIG 6  
-LP & -PP OPTION  
STENCIL FOR SEAF-20-XX.X-XX-06-X-A-LP AND SEAF-20-XX.X-X-06-X  
(SAME AS FIG 2, EXCEPT AS SHOWN) X

**PROPRIETARY NOTE**  
THIS DOCUMENT CONTAINS CONFIDENTIAL AND PROPRIETARY INFORMATION AND ALL DESIGN, MANUFACTURING, REPRODUCTION, USE, PATENT RIGHTS AND SALES RIGHTS ARE EXPRESSLY RESERVED BY SAMTEC, INC. THIS DOCUMENT SHALL NOT BE DISCLOSED, IN WHOLE OR PART, TO ANY UNAUTHORIZED PERSON OR ENTITY NOR REPRODUCED, TRANSFERRED OR INCORPORATED IN ANY OTHER PROJECT IN ANY MANNER WITHOUT THE EXPRESS WRITTEN CONSENT OF SAMTEC, INC.



520 PARK EAST BLVD, NEW ALBANY, IN 47150  
PHONE: 812-944-6733 FAX: 812-948-5047  
e-Mail info@SAMTEC.com code 55322

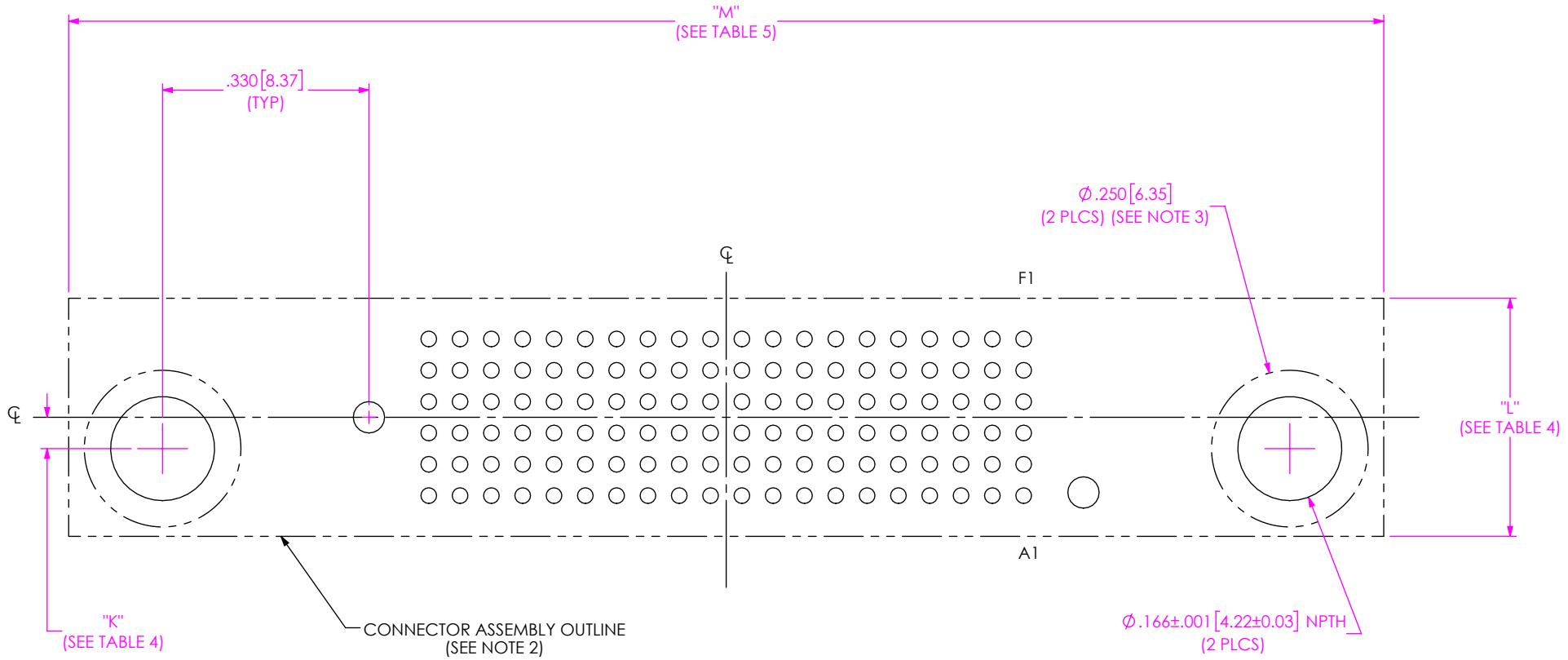

FIG 7  
 -GPK OPTION  
 FOOTPRINT FOR SEAF-20-XX.X-XX-06-X-A-GPK AND SE AFC-20-XX.X-X-06-X-X-GPK SHOWN  
 (SAME AS FIG 1, EXCEPT AS SHOWN)   
 (NOT AVAILABLE WITH -LP & -PP OPTIONS)  
 (STENCIL SAME AS FIG 2)

No. OF ROW	"K"	"L"
-04	.000 [0.00]	.280 [7.11]
-05	.050 [1.27]	.380 [9.65]
-06	.050 [1.27]	.380 [9.65]
-08	.100 [2.54]	.480 [12.19]
-10	.150 [3.81]	.580 [14.73]
-14	.250 [6.35]	.780 [19.81]

No. OF POS	"M"
-20	2.100 [53.34]
-30	2.600 [66.04]
-40	3.100 [78.74]
-50	3.600 [91.44]

- NOTES:
1. ALL DIMENSIONS ARE SYMMETRIC ABOUT THE CENTERLINE.
  2. CONNECTOR ENVELOPE DIMENSIONS, OTHER COMPONENTS PLACED ON PCB SHALL AVOID THIS ZONE.
  3. METRIC SCREW ENVELOPE ON BOTTOM SIDE OF PCB, OTHER COMPONENTS PLACED ON PCB SHALL AVOID THIS ZONE.

**PROPRIETARY NOTE**  
 THIS DOCUMENT CONTAINS CONFIDENTIAL AND PROPRIETARY INFORMATION AND ALL DESIGN, MANUFACTURING, REPRODUCTION, USE, PATENT RIGHTS AND SALES RIGHTS ARE EXPRESSLY RESERVED BY SAMTEC, INC. THIS DOCUMENT SHALL NOT BE DISCLOSED, IN WHOLE OR PART, TO ANY UNAUTHORIZED PERSON OR ENTITY NOR REPRODUCED, TRANSFERRED OR INCORPORATED IN ANY OTHER PROJECT IN ANY MANNER WITHOUT THE EXPRESS WRITTEN CONSENT OF SAMTEC, INC.



520 PARK EAST BLVD, NEW ALBANY, IN 47150  
 PHONE: 812-944-6733 FAX: 812-948-5047  
 e-Mail info@SAMTEC.com code 55322

X

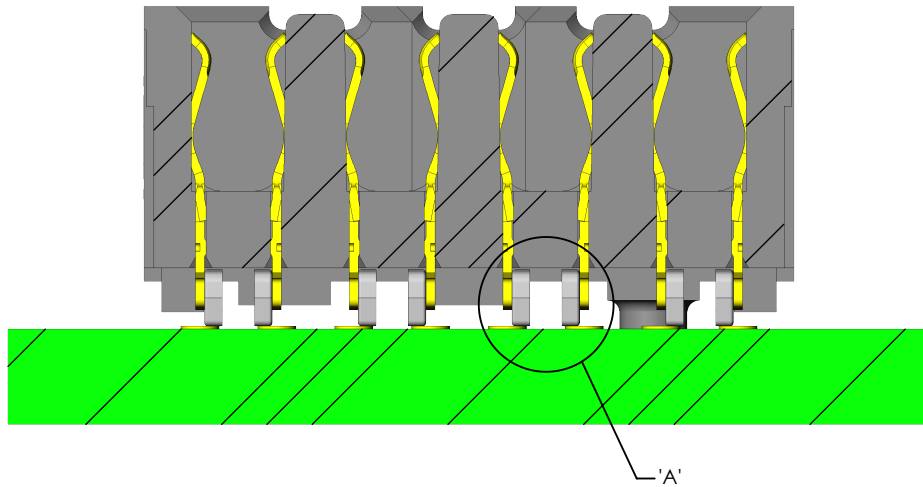

BEFORE SOLDER VIEW

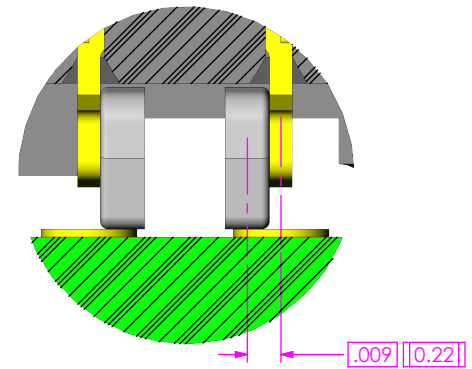

DETAIL 'A'  
SCALE 20 : 1

**PROPRIETARY NOTE**  
 THIS DOCUMENT CONTAINS CONFIDENTIAL AND PROPRIETARY INFORMATION AND ALL DESIGN, MANUFACTURING, REPRODUCTION, USE, PATENT RIGHTS AND SALES RIGHTS ARE EXPRESSLY RESERVED BY SAMTEC, INC. THIS DOCUMENT SHALL NOT BE DISCLOSED, IN WHOLE OR PART, TO ANY UNAUTHORIZED PERSON OR ENTITY NOR REPRODUCED, TRANSFERRED OR INCORPORATED IN ANY OTHER PROJECT IN ANY MANNER WITHOUT THE EXPRESS WRITTEN CONSENT OF SAMTEC, INC.



520 PARK EAST BLVD, NEW ALBANY, IN 47150  
 PHONE: 812-944-6733 FAX: 812-948-5047  
 e-Mail info@SAMTEC.com code 55322