



SUNON

SPECIFICATION FOR APPROVAL



CUSTOMER :

DESCRIPTION : AXIAL AC FAN

DIMENSIONS : 120X120X38 mm

MODEL : SP100A

P/N : 1123XBT

APPROVED NO :

(AUTHORIZED)

APPROVED BY :

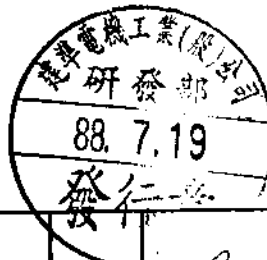

DAWN	<i>Yuchen 717</i>	CHKD.	<i>Kddy</i>	APPD.	<i>JNE</i> 8/99	SPEC. NO.	A120017
						ISSUE DATE	07.07.1999
						EDITION	0
						REVISE DATE	
						E.SPEC	EA12042

建準電機工業股份有限公司

SUNONWEALTH ELECTRIC MACHINE INDUSTRY CO., LTD.

12FL., 120 CHUNG CHENG 1ST RD.,

TEL:886-7-7163069(41 LINES)

KAOHSIUNG, TAIWAN, R. O. C. ~

FAX:886-7-7163086~89

AXIAL AC FAN

MODEL : SP100A

P/N : 1123XBT



CHARACTERISTICS

- 1. Motor Design : Reliable Shaded-Pole Motor Construction.
- 2. Insulation Resistance : 500Megohms minimum at 500 VDC.
- 3. Dielectric Strength : 1800 VAC for one minute.
- 4. Motor Protection : Impedance protected.
- 5. Noise Level : Measured in an semi-an echoic chamber with background noise level below 15 dB(A). The fan is running in free air with microphone at a distance of one meter from the fan intake.
- 6. Air Performance : Measured by a double chamber. The value are recorded when the fan speed is stabilized at rated voltage.
- 7. Tolerances : $\pm 15\%$ on rated power and current.

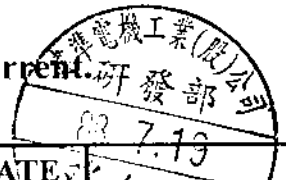

建準電機工業股份有限公司 SUNONWEALTH ELECTRIC MACHINE INDUSTRY CO., LTD	SPEC. NO.	A120017	REVISE DATE	
	ISSUE DATE	07.07.1999	EDITION	01
	PAGE	2 OF 6		

SPECIFICATIONS

MODEL : SP100A

P/N : 1123XBT

- 1-1. Rated Voltage : 115/115 VAC 50/60 HZ
- 1-2. Operating Voltage Range : 85-125 VAC
- 1-3. Starting Voltage : 85 VAC
- 1-4. Rated Speed : 2850/3150 RPM \pm 10%
- 1-5. Air Delivery : 97/117 CFM
- 1-6. Static Pressure : 0.34/0.39 Inch-H₂O
- 1-7. Rated Current : 0.26/0.24 AMP
- 1-8. Input Power : 22/20 WATTS
- 1-9. Noise Level : 45/50 dB(A)
- 1-10. Direction of Rotation : Counter-clockwise viewed front fan blade
- 1-11. Motor Protection : Impedance Protected.
- 1-12. Operating Temperature : -10 to +70 Deg.C
- 1-13. Storage Temperature : -40 to +70 Deg.C
- 1-14. Bearing System : Precise ball bearing system
- 1-15. Weight : 550g
- 1-16. Safety : UL/CSA/TUV/CE Approvals
- 1-17. Vibration : Vibration of acceleration 1.5G and Frequency 5~50~5Hz is applied in the 3 directions(X,Y,Z) for 30 minutes, each Direction at the cycle of 1 minute.



建準電機工業股份有限公司
SUNONWEALTH ELECTRIC
MACHINE INDUSTRY CO., LTD

SPEC. NO.	A120017	REVISE DATE	
ISSUE DATE	07.07.1999	EDITION	0
PAGE	3 OF 6		

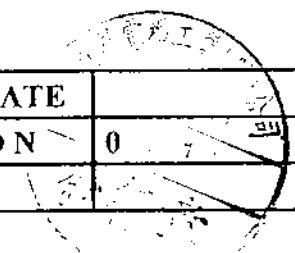

MODEL : SP100A

P/N : 1123XBT



PERFORMANCE CURVES

STATIC PRESSURE

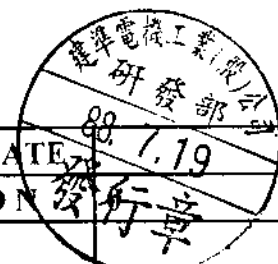
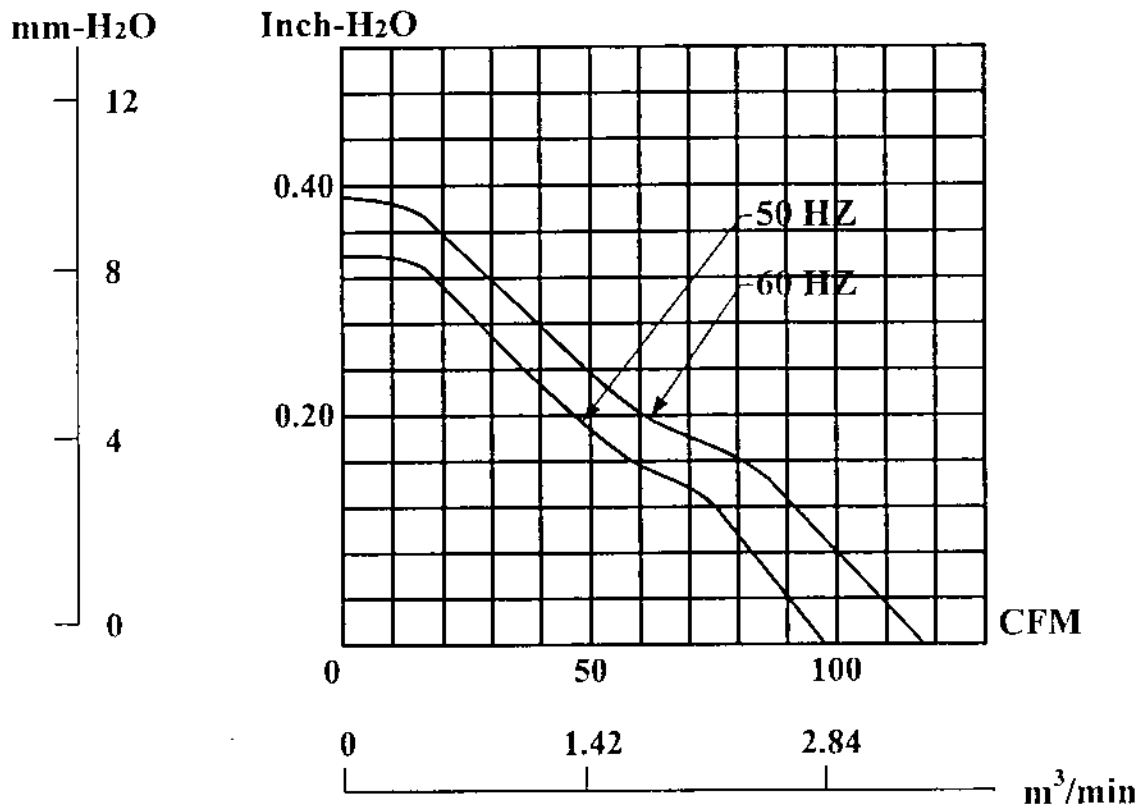

建準電機工業股份有限公司 SUNONWEALTH ELECTRIC MACHINE INDUSTRY CO., LTD	SPEC. NO.	A120017	REVISE DATE	88.7.19
	ISSUE DATE	07.07.1999	EDITION	發行章
	PAGE	4 OF 6		

MATERIAL

2. Material

2-1. Frame : DIE-CAST ALUMINUM

2-2. Impeller : Thermoplastic PBT of UL 94V-0

DIMENSIONS

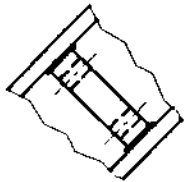

ROTATION



AIR FLOW

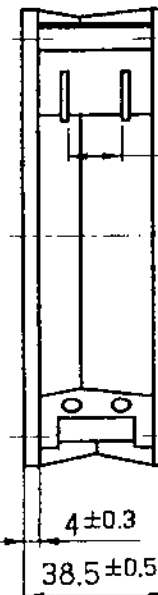
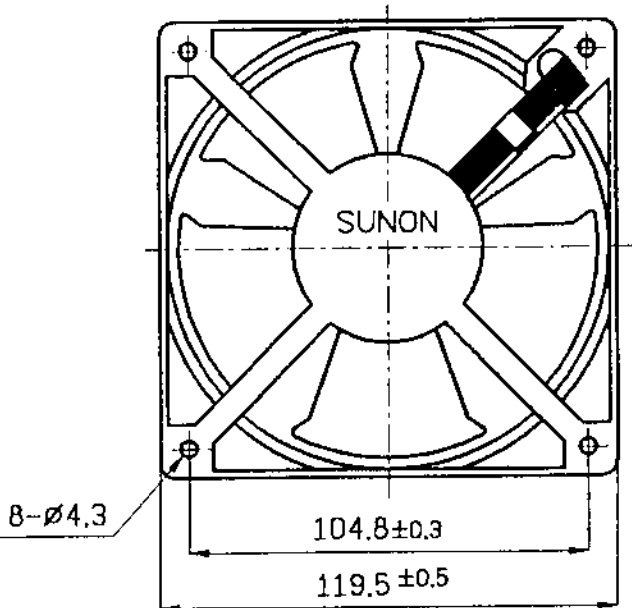

TERMINAL
(THICK 0.5)
6.9

- 1. Air Flow Direction: Label side.
- 2. The Best Mounting Direction: In any orientation.

UNITS : mm

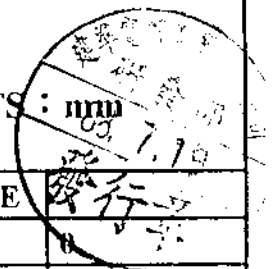

建準電機工業股份有限公司 SUNONWEALTH ELECTRIC MACHINE INDUSTRY CO., LTD	SPEC. NO.	A120017	REVISE DATE	
	ISSUE DATE	07. 07. 1999	EDITION	
	PAGE	5 OF 6		

Notes



1. SUNON will not guarantee the products if the application of our products is exceeded the limitation which is specified on this specification.
2. In case of change of the specification specified on this document, a written notice is requested in advance.
3. Please do not touch the impeller with pressure and never bring the fan with lead wire. The bearings and lead wire may be damaged.
4. No guarantee on the products against the safety problem or failure caused by powder dust, drop of water or insect.
5. If there is any data or related documentation different from this data sheet, this data sheet is the principal reference.
6. For the purpose of MIS, please indicate SPEC No. on every order.
7. In case of the fan has no polarity protection function, wires with same color (electrode) must be connected together during the assembly. (i.e. red+red, black+black) or the fan will be damaged immediately.
8. Please do not use the fan in the environment of corrosive gas or liquid or any detrimental gas.
9. Please do not store the fan in the environment of high / low temperature, high humidity or any detrimental gas. Please store the fan within 6 months, every 6 months, there shall be a linkage of electric current to the fan, even though the fan is stored in room temperature.
10. While the fan is in operation, please do not lock the fan intentionally for a long period of time, since the continuous stoppage will result in over-heat and thus burn-out of the fan.
11. During the installation of the fan, please pay substantial attention to possible noise cause by resonance vibration and vibration.
12. During the testing of the fan, please be sure to use finger guard to insure safety.

建準電機工業股份有限公司
SUNONWEALTH ELECTRIC
MACHINE INDUSTRY CO., LTD

SPEC. NO.	A120017	REVISE DATE	
ISSUE DATE	07. 07. 1999	EDITION	0
PAGE	6 OF 6		