

10 9 8 7 6 5 4 3 2 1

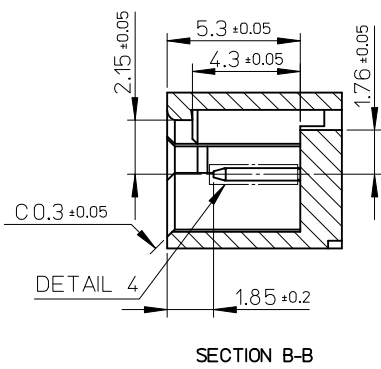
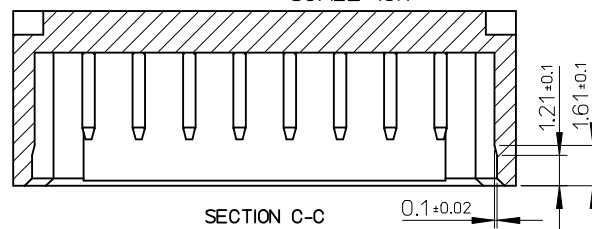
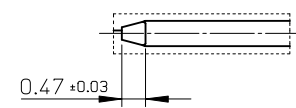
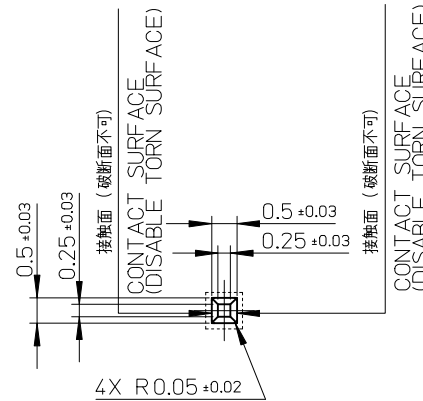
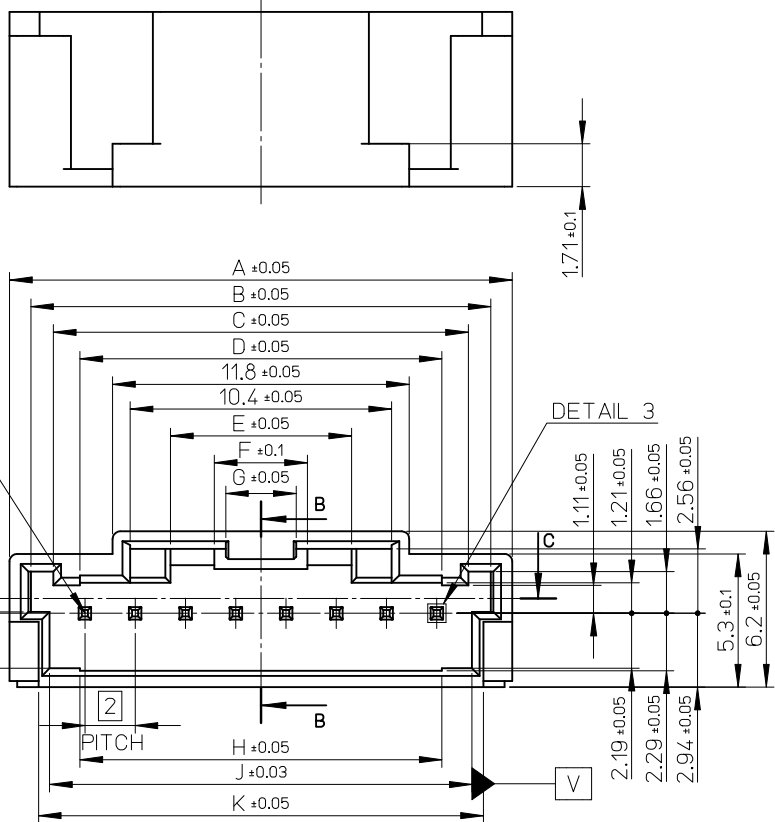

31.7	30.8	28.4	2.8	3.7	7.2	28.4	30.5	32.3	34	15
29.7	28.8	26.4	2.8	3.7	7.2	26.4	28.5	30.3	32	14
27.7	26.8	24.4	2.8	3.7	7.2	24.4	26.5	28.3	30	13
25.7	24.8	22.4	2.8	3.7	7.2	22.4	24.5	26.3	28	12
23.7	22.8	20.4	2.8	3.7	7.2	20.4	22.5	24.3	26	11
21.7	20.8	18.4	2.8	3.7	7.2	18.4	20.5	22.3	24	10
19.7	18.8	16.4	2.8	3.7	7.2	16.4	18.5	20.3	22	9
17.7	16.8	14.4	2.8	3.7	7.2	14.4	16.5	18.3	20	8
15.7	14.8	12.4	2.8	3.7	7.2	12.4	14.5	16.3	18	7
13.7	12.8	10.4	2.8	3.7	7.2	10.4	12.5	14.3	16	6
11.7	10.8	8.4	2.8	3.7	7.2			12.3	14	5
9.7	8.8	6.4	2.8	3.7	7.1			10.3	12	4
7.7	6.8	4.4	2	2.9	5.1			8.3	10	3
										2
K	J	H	G	F	E	D	C	B	A	CKT

注記 NOTES

- 弊社製品寸法を保証するものではありません。 THIS DRAWING IS NOT GUARANTY DIMENSIONS FOR MOLEX PRODUCT.
- 嵌合相手 MATES WITH
502351-**-0*: DuraClik
505151-**-00: DuraClik TPA
560123-**-0*: DuraClik ISL
- メッキ仕様
ピン: 銅合金、ニッケル下地(1μm以上)、錫メッキ(1μm以上)
PLATING SPEC
PIN: COPPER ALLOY, TIN(1μm MIN.) OVER NICKEL(1μm MIN.) PLATE.
- 参照図面
REFERENCE DRAWING
SD-502352-001

RECOMMENDED DIMENSIONS FOR CONNECTOR INTERFACE

RELEASED EC NO.: JTR2016-0011 DRWN: YAMAKI 2015/03/25 CHKD: HKOMATSU 2015/07/24 APPR: MAYAMAMOTO 2015/07/24	QUALITY SYMBOLS ▽=0 △=0 ◇=0	GENERAL TOLERANCES (UNLESS SPECIFIED)		DIMENSION STYLE		SCALE	DESIGN UNITS		THIRD ANGLE PROJECTION	
		mm	INCH	MM ONLY	5:1	METRIC				
O	REV	4 PLACES	±---	±---	DRAWN BY	DATE	TITLE 2.0MM PITCH W/B CONN. INTERFACE DRAWING			
		3 PLACES	±---	±---	YAMAKI	2015/03/25				
		2 PLACES	±---	±---	CHECKED BY	DATE	DOCUMENT NO. SD-502352-003-JP			
		1 PLACE	±---	±---	HKOMATSU	2015/07/24				
		0 PLACE	±---	±---	APPROVED BY	DATE	SHEET NO. 1 OF 2			
					MAYAMAMOTO	2015/07/24				
		ANGULAR ± - °		MATERIAL NO.						
		DRAFT WHERE APPLICABLE MUST REMAIN WITHIN DIMENSIONS		SIZE	THIS DRAWING CONTAINS INFORMATION THAT IS PROPRIETARY TO MOLEX INCORPORATED AND SHOULD NOT BE USED WITHOUT WRITTEN PERMISSION					
				A3						

9 8 7 6 5 4 3 2 1

	10	9	8	7	6	5	4	3	2	1
F	15									
	14									
	13									
	12									
	11									
	10	560123								
	9		505151							
	8	560123		502351						
	7									
	6	560123								
	5									
E	4									
	3	560123								
	2									
CKTS		ISL Receptacle	TPA Receptacle	Standard Receptacle						
		Mate With Series								

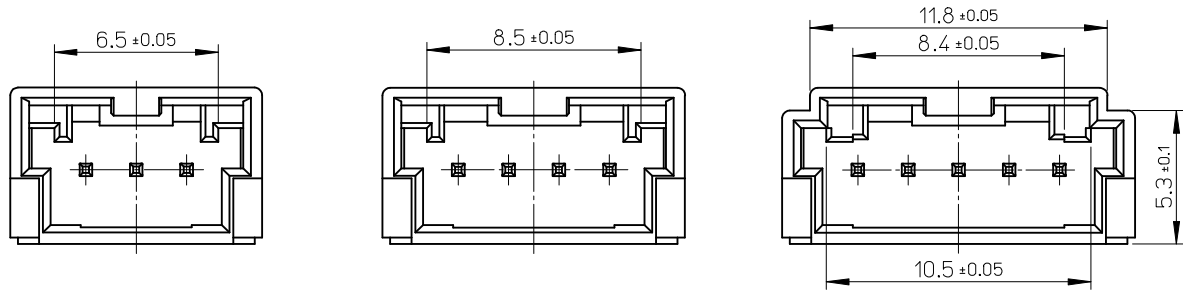
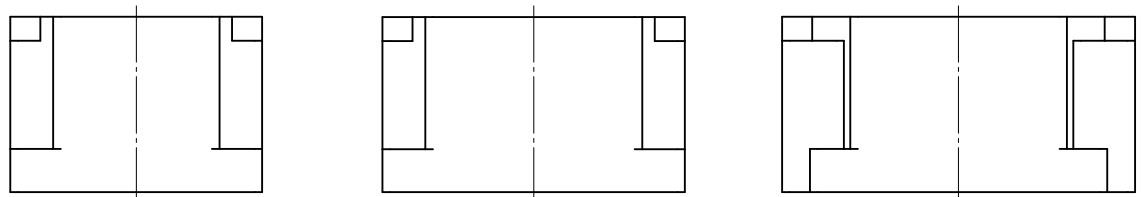

3極 3CKT 4極 4CKT 5極 5CKT

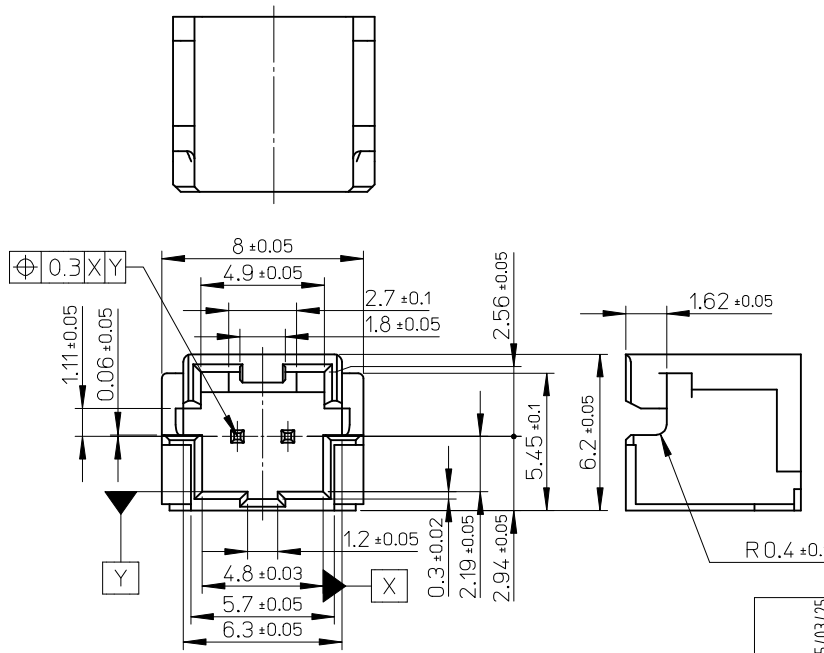

2極 2CKT

RECOMMENDED DIMENSIONS FOR CONNECTOR INTERFACE

RELEASED EC NO: JTR2016-0011 DRWN: YAMAKI 2015/03/25 CHKD: KOMATSU 2015/07/24 APPR: MAYAMOTO 2015/07/24	QUALITY SYMBOLS $\nabla_{\text{A}} = 0$ $\nabla_{\text{B}} = 0$ $\nabla_{\text{C}} = 0$	GENERAL TOLERANCES (UNLESS SPECIFIED)		DIMENSION STYLE MM ONLY	SCALE 5:1	DESIGN UNITS METRIC	THIRD ANGLE PROJECTION
		mm	INCH	DRAWN BY YAMAKI	DATE 2015/03/25	TITLE 2.0MM PITCH W/B CONN. INTERFACE DRAWING	
REV 0	DESCRIPTION	DRAFT WHERE APPLICABLE MUST REMAIN WITHIN DIMENSIONS		CHECKED BY HKOMATSU	DATE 2015/07/24	molex	
		MATERIAL NO. ---		APPROVED BY MAYAMOTO	DATE 2015/07/24	DOCUMENT NO. SD-502352-003-JP	SHEET NO. 2 OF 2
SIZE A3				THIS DRAWING CONTAINS INFORMATION THAT IS PROPRIETARY TO MOLEX INCORPORATED AND SHOULD NOT BE USED WITHOUT WRITTEN PERMISSION			