



A Product Line of
Diodes Incorporated



SPECIFICATION FOR APPROVAL

CUSTOMER _____

NOMINAL FREQUENCY 8.000000 MHz



PRODUCT TYPE TYPE FL 3.2x2.5 SEAM SEALED CRYSTAL

SPEC. NO. (P/N) FL0800005Q

CUSTOMER P/N _____

ISSUE DATE October 19, 2017

VERSION B

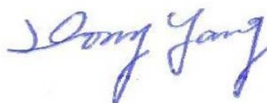
APPROVED	PREPARED	QA
		

Diodes Incorporated

No.2, Ziqiang 5th Rd., Zhongli Industrial Park,
Zhongli Dist., Taoyuan City 32063, Taiwan (R.O.C.)
TEL: 886-3-451-8888
FAX: 886-3-461-3865
<https://www.diodes.com>

- *Pb-free
- *RoHS Compliant
- *HF-Halogen Free
- *REACH Compliant
- *AEC-Q200 Compliant

TYPE FL 3.2x2.5 SEAM SEALED CRYSTAL

FL0800005Q

VER. B 19-Oct-17

ELECTRICAL SPECIFICATIONS

Item	Symbol	Specifications	Units	Notes
Nominal Frequency	Fn	8.000000	MHz	
Mode of Oscillation	MO	AT Cut-Fundamental		
Calibration Load Capacitance	CL	8	pF	
Calibration Tolerance	FL	±50	ppm	at 25°C±3°C
Operating Temperature Range	TR	-40 to +125	°C	
Frequency Stability (Frequency Deviation over the Operating Temperature Range)	F/T	±70	ppm	Reference to the Frequency at 25°C
Operating Drive Level		10	μW	
Maximum Drive Level		100	μW	
Equivalent Series Resistance	ESR	600	Ω	Max
Shunt Capacitance	C0	5	pF	Max
Aging at 25°C		±3	ppm	Max, 1st year
Storage Temperature		-55 to +125	°C	
Insulation Resistance		500	MΩ	Min

※ This product doesn't include harmful substance that stipulated by SONY SS-00259 Level 1 and S-AT2-001 Level 1 standard. RoHS Compliant (Pb - Free).

TYPE FL 3.2x2.5 SEAM SEALED CRYSTAL

FL0800005Q

VER. B 19-Oct-17

AEC-Q200 RELIABILITY TEST SPECIFICATIONS:

1. Initial

- 1.1 Physical Dimensions: JESD22, Method JB1-100
- 1.2 External Visual: MIL-STD-883, Method 2009
- 1.3 Freq. Vs. Temperature: Per Specification/Datasheet

2. Mechanical

- 2.1 Mechanical Shock: MIL-STD-202 Method 213
- 2.2 Vibration: MIL-STD-202 Method 204
- 2.3 Solderability: J-STD-002
- 2.4 Board Flex: AEC Q200-005
- 2.5 Terminal Strength (SMD): AEC Q200-006

3.Environmental

- 3.1 Temp Cycle: JESD22, Method JA-104
- 3.2 Resistance to Solder Heat: MIL-STD-202 Method 210
- 3.3 High Temperature Operating Life: MIL-STD-202, Method 108
- 3.4 High Temp Exposure: MIL-STD-202, Method 108
- 3.5 High Temp & High Humidity: MIL-STD-202, Method 103
- 3.6 Thermal Shock: MIL-STD-202, Method 107

SUGGESTED IR REFLOW PROFILE

*As per IPC-JEDEC J-STD-020D

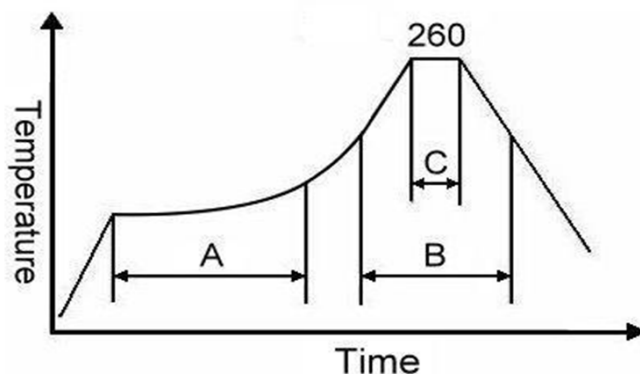

Note:

	Stage	Temperature	Time
A	Preheat	150~200°C	60~120 Sec
B	Primary Heat	217°C	60~150 Sec
C	Peak	260°C	10 Sec

TYPE FL 3.2x2.5 SEAM SEALED CRYSTAL

FL0800005Q

VER. B 19-Oct-17

MARKING

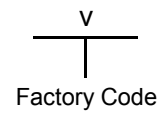
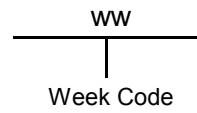
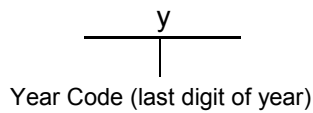
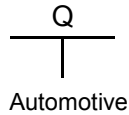
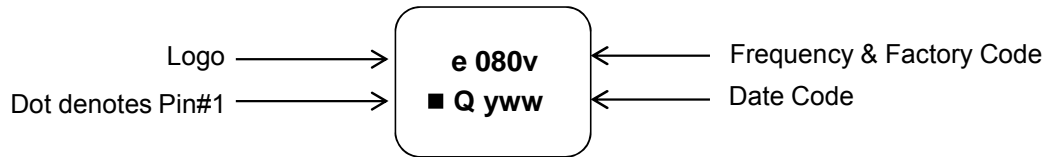

MECHANICAL DRAWINGS (Scale: None. Dimensions are in mm.)

Recommended Land Pattern

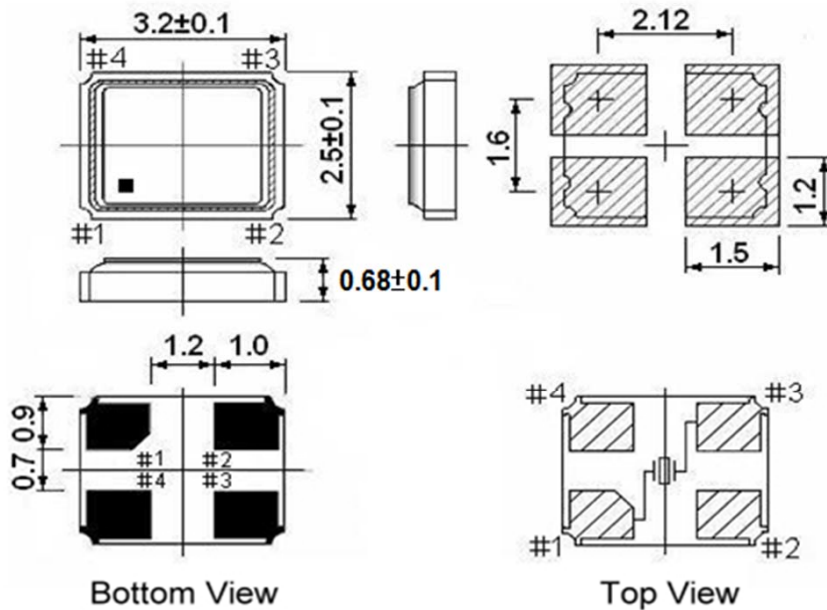

**** Recommended - Pin 1 & 3 : CRYSTAL
 Pin 2 & 4 : GND**

Notes:

1. Package drawings are for reference only, and the appearances of objects may vary.
 Actual packages are based on the real product.
2. The marking dot denotes Pin#1.
3. The position and shape of the chamfer pin may vary and are based on the real product.

TYPE FL 3.2x2.5 SEAM SEALED CRYSTAL

FL0800005Q

VER. B 19-Oct-17

Tape & Reel

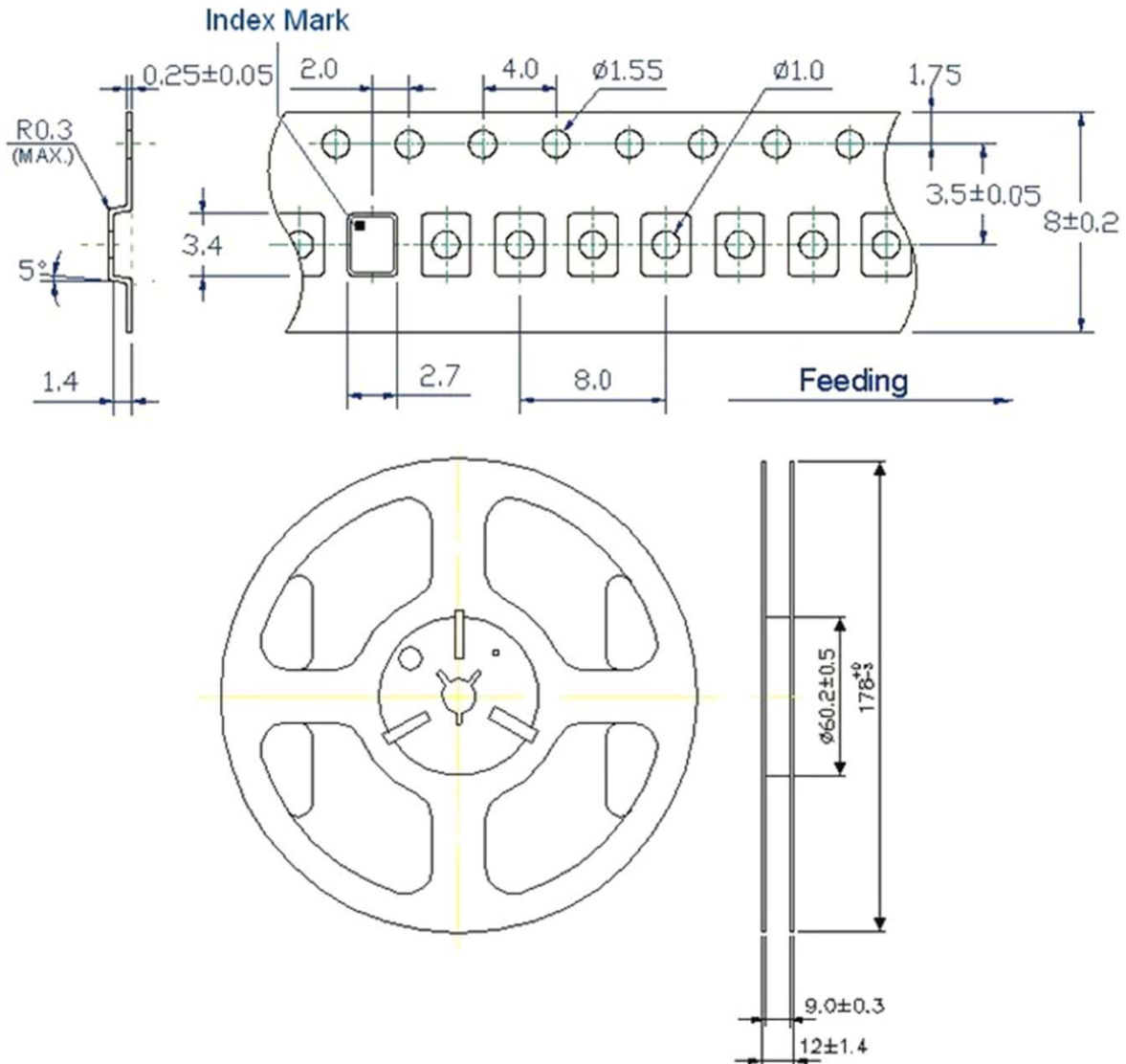

1. 230mm minimum leader which consist of carrier and/or tape followed by a minimum of 160mm of empty carrier tape sealed with cover tape.
2. 160mm minimum trailer of empty carrier tape sealed with cover tape.

TYPE FL 3.2x2.5 SEAM SEALED CRYSTAL

FL0800005Q

VER. B 19-Oct-17

PACKING

