

Ratings

Voltage: 300 V
 Temperature: -40~105 °C
 Flammability: VW-1

Conductor

Conductor count: 4
 Gauge: 28 AWG 0.1 mm²
 Material: tinned copper strands
 Strand size: $\varnothing 0.08 \times 19$
 Resistance at 20 °C: 239 Ω /km max

Insulator

Material: FEP
 Color: red, black, white, yellow
 Diameter: $\varnothing 0.72 \pm 0.10$
 Nominal thickness: 0.13 mm
 Resistance at 20 °C: 10 M Ω /km min

Filler

Material: aramid fiber

Wrap

Material: cotton paper

Outer jacket

Material: TPE
 Color: black
 Diameter: $\varnothing 3.2 \pm 0.15$
 Nominal thickness: 0.6 mm

Wire marking: E339579 UL AWM STYLE 21296 28 AWG 105°C
 300V VW-1 --- cUL AWM I A 105°C 300V FT1 TENSILITY DGT

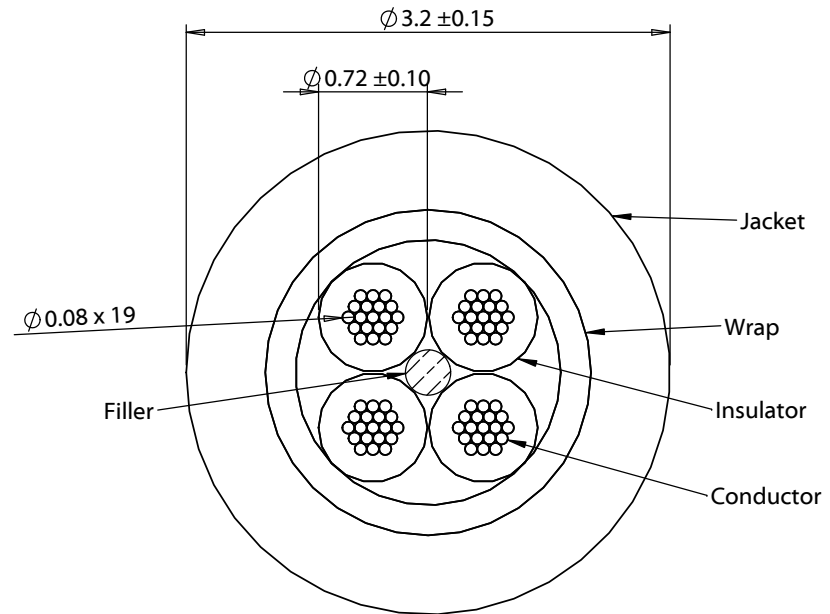
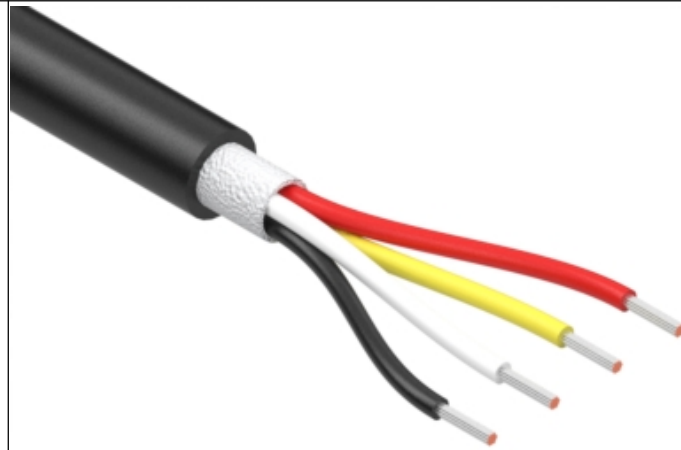

Revision:	Date:	Description:	Prepared:	Notes: RoHS compliant Phthalate free Function test: no open, no short circuit, no intermittent	<h1>TENSILITY</h1> <p>tel 1.541.323.3228 800 877.670.7118 fax 1.541.323.4202 web tensility.com</p>	
A	4/28/2021	Initial release	Verified:			
			Dimensions are in millimeters. Tolerances: X: ± 0.5 mm X.X: ± 0.3 mm X.XX: ± 0.05 mm	Description:	Size: Part number:	
				Wire, 4C TS, 28 AWG, UL 21296, 300V, 105C, 3.2 mm, TPE	A 30-01921	
				Scale: 20:1		Sheet 1 of 1

5

4

3

2

1