

THIS DOCUMENT IS SUBJECT TO CHANGE WITHOUT NOTICE. IT IS CONFIDENTIAL AND A PROPERTY OF AMPHENOL LTW. DISCLOSURE TO THIRD PARTY HAS TO BE AUTHORIZED BY AMPHENOL LTW.

REV.	ECN NO.	DATE	SIGN	DESCRIPTION
A		2022/09/30	Eagle	Rev.01 to Rev.A

DT-HCN-XXRFF-RHA30

For 12P

- G3: 3Pin
- G4: 4Pin
- G6: 6Pin
- 08: 8Pin
- 12: 12Pin

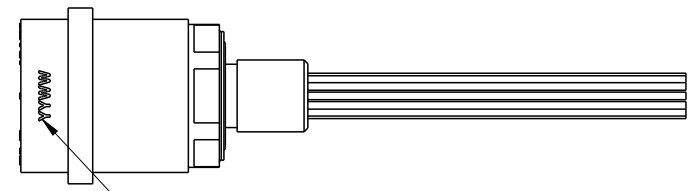
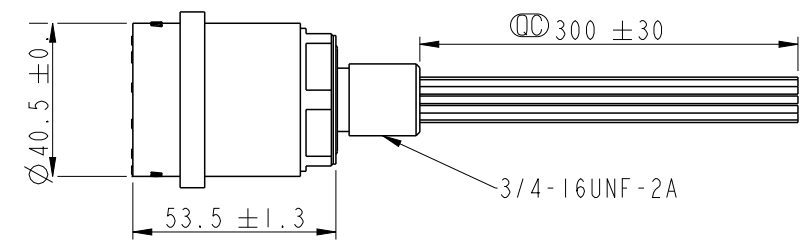
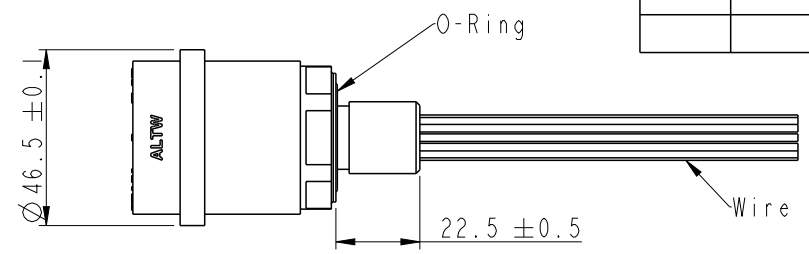
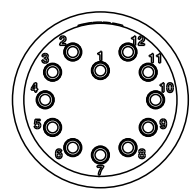

☉ Date Code(Laser mark)
 YY(年)
 WW(週)
 上下左右置中

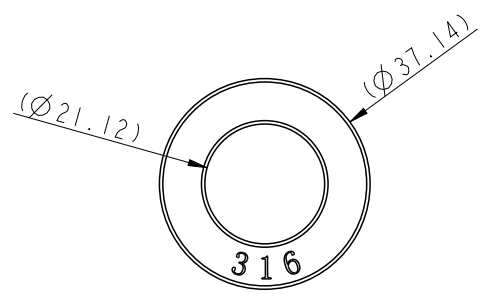

Washer

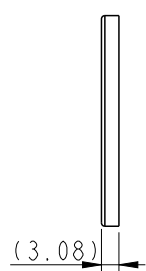

3/4-16UNF-2B

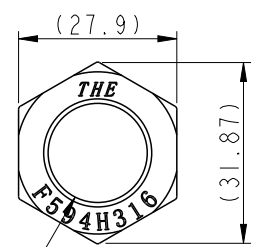

Nut

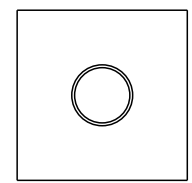
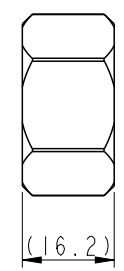

6.40 (Min.)/11.1 (Max.)

Panel cut out (screw type)

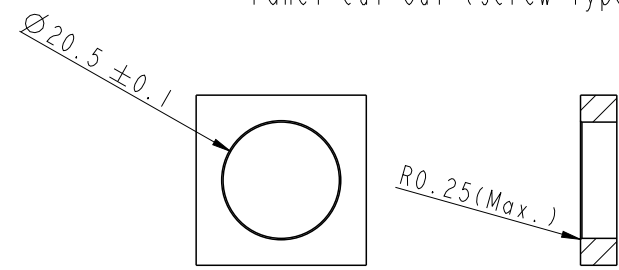

6.40 (Min.)/11.1 (Max.)

Panel cut out (hole type)

- Note:
- * ☉ Important Dimension.
 - * Waterproof Rate: Hadopelagic 7000M, Mated.
 - * Connector
 Housing : Rubber, Black.
 Pin : Copper Alloy, Gold Plated.
 O-Ring: Rubber, Black.
 Shield: Metal.
 Nut: Metal.
 Washer: Metal.
 - * Wire: UL10393 18 AWG, OD 1.81mm
 - * Washer and nut are packed separately in PE bag.

UNIT: mm TOLERANCE ±0.5	TITLE DT, HAD CIRCULAR MINI REAR FASTENED, F, F		<h1 style="text-align: center;">Amphenol LTW</h1> <p style="text-align: center;">安費諾亮泰企業股份有限公司</p>		ITEM NO	DRAWN BY Eagle	DATE 2022/09/30
	SCALE 1:1	SIZE A4			SHEET 1	OF 5	DWG NO DT-HCN-XXRFF-RHA30
	REV. A	WC-REV. A.5	☉: Inspection item	CUSTOMER ALTW	APPROVED BY Max	DATE 2022/09/30	

THIS DOCUMENT IS SUBJECT TO CHANGE WITHOUT NOTICE. IT IS CONFIDENTIAL AND A PROPERTY OF Amphenol LTW. DISCLOSURE TO THIRD PARTY HAS TO BE AUTHORIZED BY Amphenol LTW.

For 6P/8P

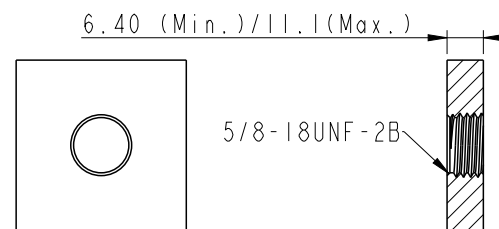
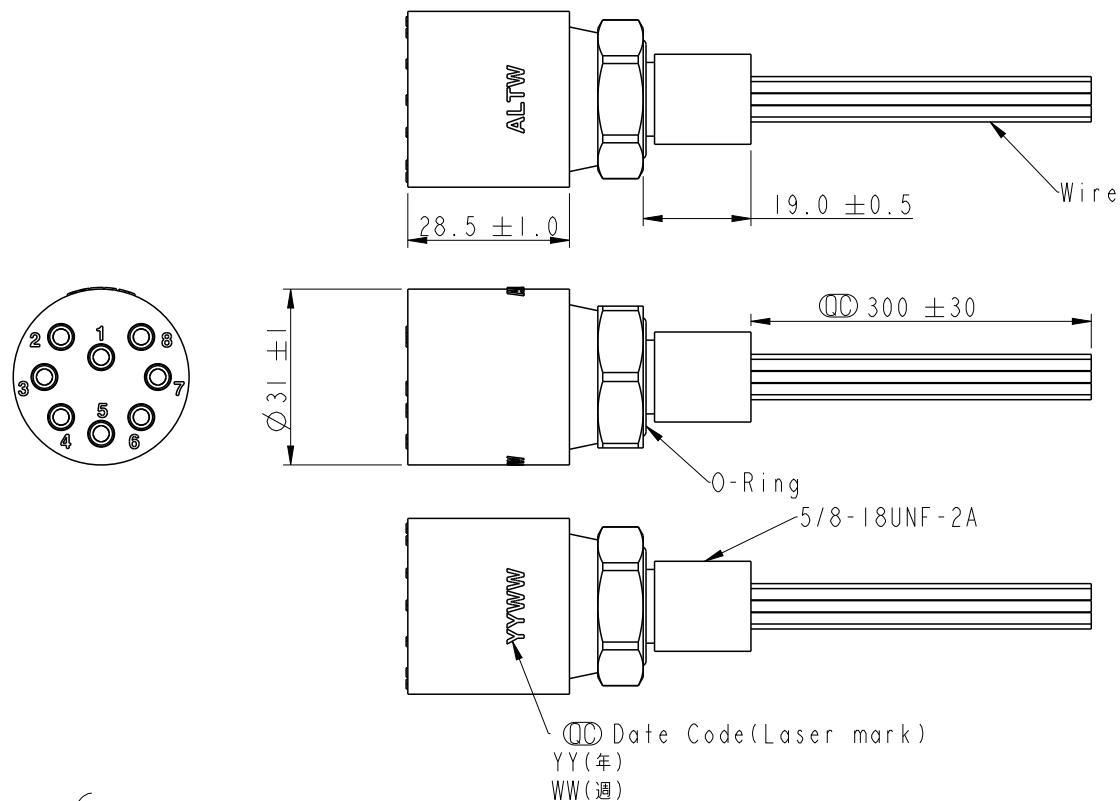

Panel cut out (screw type)

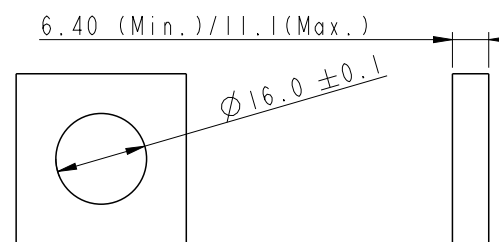

Panel cut out (hole type)

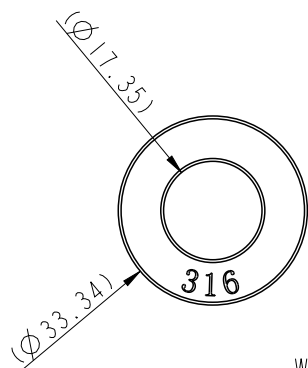

Washer

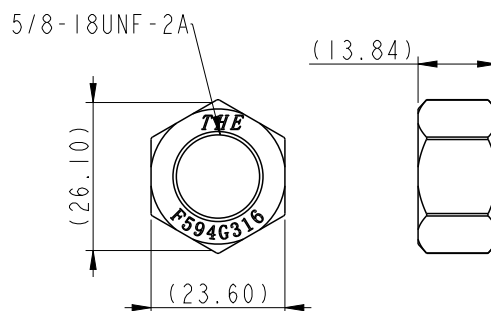

Nut

UNIT: mm

TOLERANCE
± 0.5

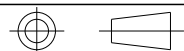

TITLE DT, HAD CIRCULAR MINI REAR FASTENED, F, F			
SCALE 1:1	SIZE A4	SHEET 2 OF 5	
REV. A	WC-REV. A.5	☉: Inspection item	

Amphenol LTW
安費諾亮泰企業股份有限公司

ITEM NO	DRAWN BY Eagle	DATE 2022/09/30
DWG NO DT-HCN-XXRFF-RHA30	CHECKED BY Aric	DATE 2022/09/30
CUSTOMER ALTW	APPROVED BY Max	DATE 2022/09/30

THIS DOCUMENT IS SUBJECT TO CHANGE WITHOUT NOTICE. IT IS CONFIDENTIAL AND A PROPERTY OF Amphenol LTW. DISCLOSURE TO THIRD PARTY HAS TO BE AUTHORIZED BY Amphenol LTW.

For 3P/4P

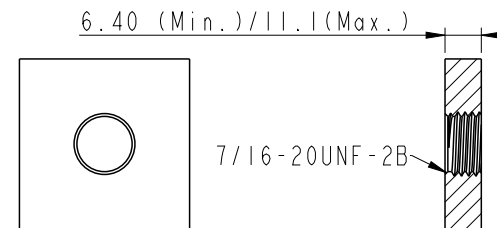
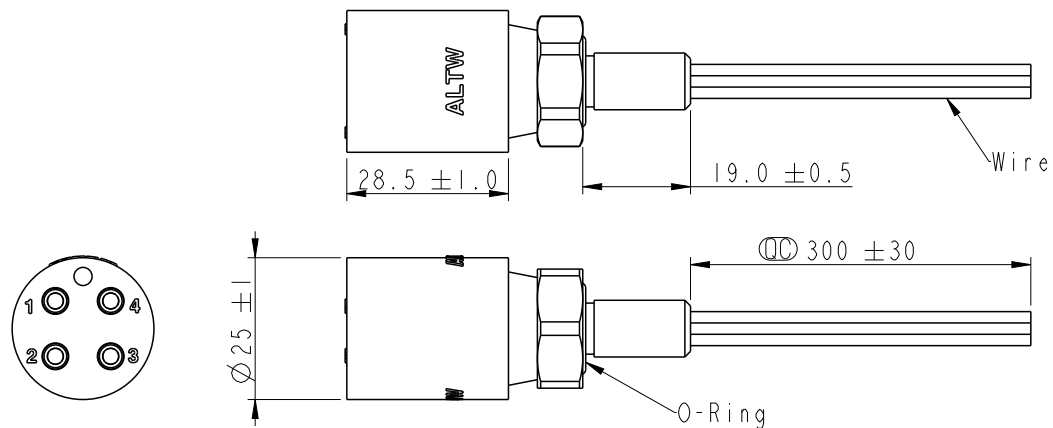

Panel cut out (screw type)

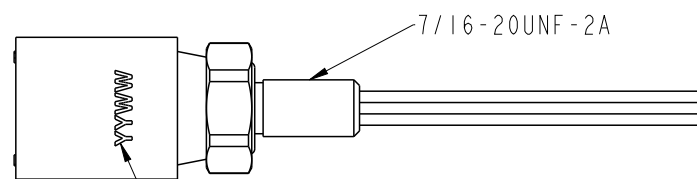

☉ Date Code(Laser mark)
YY(年)
WW(週)

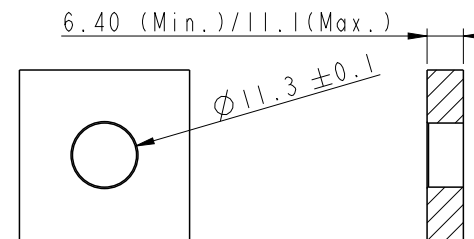

Panel cut out (hole type)

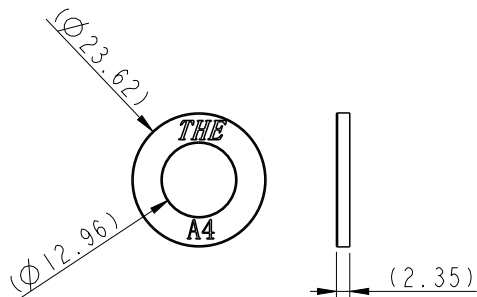

Washer

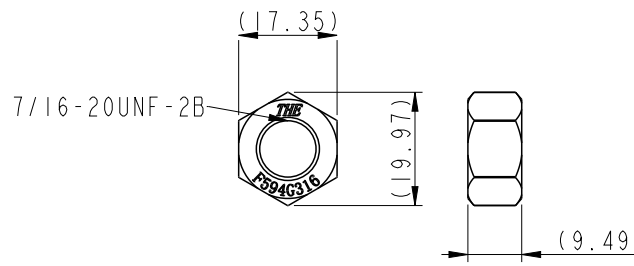

Nut

UNIT:mm
TOLERANCE
±0.5

TITLE DT, HAD CIRCULAR MINI REAR FASTENED, F, F			
SCALE 1:1	SIZE A4	SHEET 3 OF 5	
REV. A	WC-REV. A.5	☉: Inspection item	

Amphenol LTW
安費諾亮泰企業股份有限公司

ITEM NO	DRAWN BY Eagle	DATE 2022/09/30
DWG NO DT-HCN-XXRFF-RHA30	CHECKED BY Aric	DATE 2022/09/30
CUSTOMER ALTW	APPROVED BY Max	DATE 2022/09/30

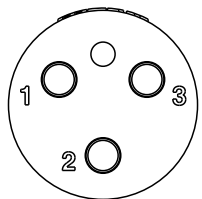

Pin Assignment(Front View)

- Pin Out (3P)
 1 Black(黑) 18AWG
 2 White(白) 18AWG
 3 Red(紅) 18AWG

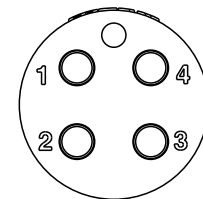

Pin Assignment(Front View)

- Pin Out (4P)
 1 Black(黑) 18AWG
 2 White(白) 18AWG
 3 Red(紅) 18AWG
 4 Green(綠) 18AWG

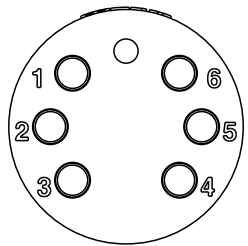

Pin Assignment(Front View)

- Pin Out (6P)
 1 Black(黑) 18AWG
 2 White(白) 18AWG
 3 Red(紅) 18AWG
 4 Green(綠) 18AWG
 5 Orange(橙) 18AWG
 6 Blue(藍) 18AWG

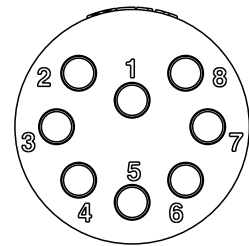

Pin Assignment(Front View)

- Pin Out (8P)
 1 Black(黑) 18AWG
 2 White(白) 18AWG
 3 Red(紅) 18AWG
 4 Green(綠) 18AWG
 5 Orange(橙) 18AWG
 6 Blue(藍) 18AWG
 7 White/Black(白/黑) 18AWG
 8 Red/Black(紅/黑) 18AWG

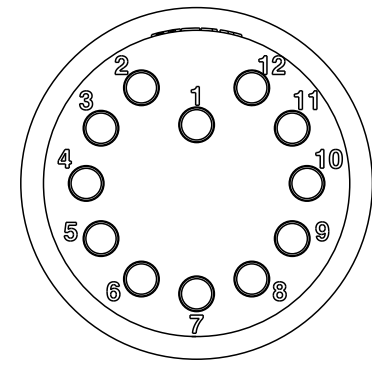

Pin Assignment(Front View)

- Pin Out (12P)
 1 Black(黑) 18AWG
 2 White(白) 18AWG
 3 Red(紅) 18AWG
 4 Green(綠) 18AWG
 5 Orange(橙) 18AWG
 6 Blue(藍) 18AWG
 7 White/Black(白/黑) 18AWG
 8 Red/Black(紅/黑) 18AWG
 9 Green/Black(綠/黑) 18AWG
 10 Orange/Black(橙/黑) 18AWG
 11 Blue/Black(藍/黑) 18AWG
 12 Black/White(黑/白) 18AWG

UNIT:mm
 TOLERANCE

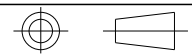

TITLE DT, HAD CIRCULAR MINI REAR FASTENED, F, F			
SCALE 1:2	SIZE A4	SHEET 4 OF 5	
REV. A	WC-REV.	QC: Inspection item	

Amphenol LTW
 安費諾亮泰企業股份有限公司

ITEM NO	DRAWN BY Eagle
DWG NO DT-HCN-XXRFF-RHA30	CHECKED BY Aric
CUSTOMER ALTW	APPROVED BY Max

DATE 2022/09/30
DATE 2022/09/30
DATE 2022/09/30

THIS DOCUMENT IS SUBJECT TO CHANGE WITHOUT NOTICE. IT IS CONFIDENTIAL AND A PROPERTY OF Amphenol LTW. DISCLOSURE TO THIRD PARTY HAS TO BE AUTHORIZED BY Amphenol LTW.

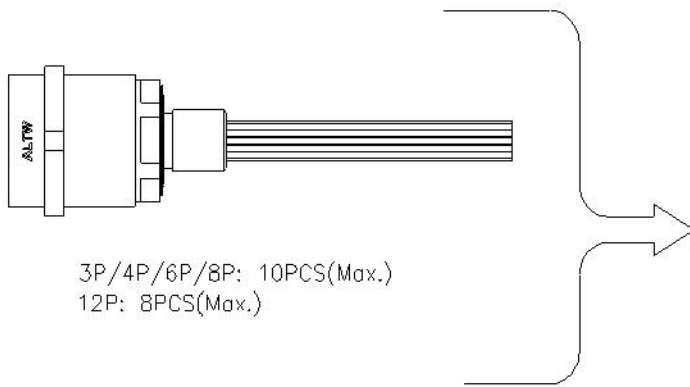

3P/4P/6P/8P: 10PCS(Max.)
12P: 8PCS(Max.)

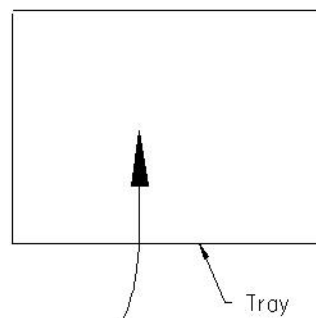

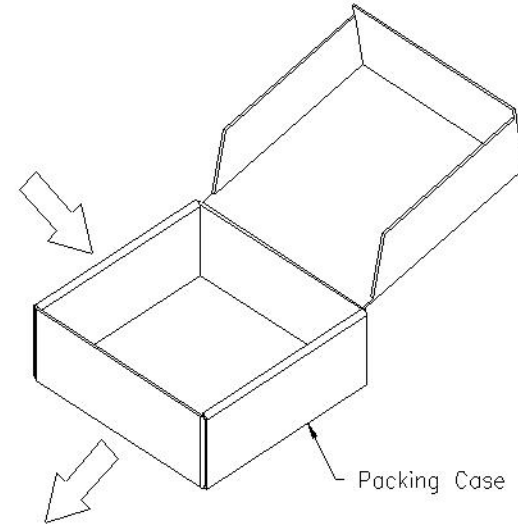

Tray

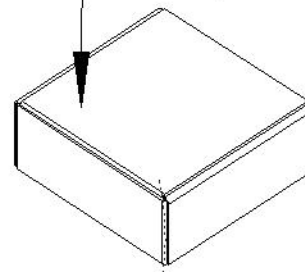

Packing Case



年 月 ALTW 合格品 RoHS2.0	
料號: _____	廠商: 昆山安費諾正日電子
	
數量: _____ PC	日期: _____
Lot No: _____	版本: _____
	
採購單號: _____	
	
廠商料號: _____	

UNIT: mm		
TOLERANCE ±0.5		

TITLE DT, HAD CIRCULAR MINI REAR FASTENED, F, F			
SCALE 1:1	SIZE A4	SHEET 5 OF 5	
REV. A	WC-REV. A.5	☉: Inspection item	

Amphenol LTW
安費諾亮泰企業股份有限公司

ITEM NO	DRAWN BY Eagle	DATE 2022/09/30
DWG NO DT-HCN-XXRFF-RHA30	CHECKED BY Aric	DATE 2022/09/30
CUSTOMER ALTW	APPROVED BY Max	DATE 2022/09/30