

# Wideband Distributed Amplifier

## 30 kHz - 50 GHz



MAAM-011275

Rev. V1

### Features

- Wide Frequency Range: 30 kHz - 50 GHz
- 14.5 dB Gain
- 3 - 8 V DC, 200 mA
- 20.5 dBm P1dB @ 21 GHz
- Integrated Power Detector with a Detector Reference Voltage Generator
- 50  $\Omega$  Input and Output Match
- Lead-Free 5 mm 12-Lead AQFN Package
- RoHS\* Compliant

### Applications

- Instrumentation and Communication Systems

### Description

MAAM-011275 is an easy-to-use, wideband amplifier that operates from 30 kHz to 50 GHz. The amplifier provides 14.5 dB gain, 20.5 dBm output power and 4 dB noise figure. It is matched to 50  $\Omega$  with typical return loss better than 10 dB.

MAAM-011275 is suitable for a wide range of applications in instrumentation and communication systems.

### Ordering Information<sup>1,2</sup>

Part Number	Package
MAAM-011275-TR0500	500 Piece Reel
MAAM-011275-SB1	Sample Board

1. Reference Application Note M513 for reel size information.
2. All sample boards include 5 loose parts.

### Functional Schematic

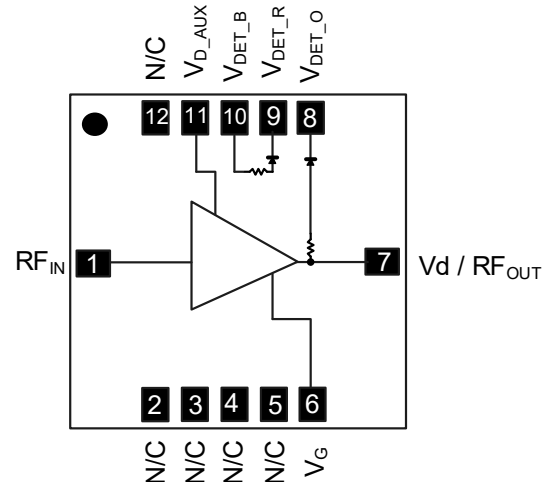

### Pin Configuration<sup>3,4</sup>

Pin #	Pin Name	Description
1	RF <sub>IN</sub>	RF Input
2,3,4,5,12	N/C	Not Connected
6	V <sub>G1</sub>	Gate Voltage 1
7	RF <sub>OUT</sub> /V <sub>DD</sub>	RF Output
8	DET <sub>OUT</sub>	Output Detector
9	DET <sub>REF</sub>	Reference Detector
10	DET <sub>BIAS</sub>	Detector Bias
11	V <sub>DAUX</sub>	Auxiliary Drain Voltage

3. MACOM recommends connecting unused package pins to ground.
4. The exposed pad centered on the package bottom must be connected to RF, DC and thermal ground.

\* Restrictions on Hazardous Substances, compliant to current RoHS EU directive.

# Wideband Distributed Amplifier

## 30 kHz - 50 GHz



MAAM-011275

Rev. V1

**Electrical Specifications:  $T_C = 25\text{ }^\circ\text{C}$ ,  $V_{DD} = 7\text{ V}$ ,  $Z_0 = 50\text{ }\Omega$**

Parameter	Test Conditions	Units	Min.	Typ.	Max.
Gain	5 GHz 20 GHz 45 GHz	dB	13 13 11	15 15 14	—
Gain Flatness	1 - 50 GHz	dB	—	$\pm 1$	—
Input Return Loss	1 - 50 GHz	dB	—	10	—
Output Return Loss	1 - 50 GHz	dB	—	10	—
P1dB	21 GHz	dBm	—	20.5	—
P3dB	5 GHz 20 GHz 45 GHz	dB	23 22 17	24.5 23.5 19	—
Output IP3	$P_{IN} = -4\text{ dBm}$ / tone, 21 GHz tone spacing = 2 MHz	dBm	—	29	—
Noise Figure	26 GHz 40 GHz	dB	—	3.2 6.5	—
Drain Current <sup>5</sup>	Quiescent bias	mA	—	200	—

5. Set by adjusting VG1 as outlined in operating conditions on page 3.

### Absolute Maximum Ratings<sup>6,7</sup>

Parameter	Absolute Maximum
Input Power	17 dBm
Drain Supply Voltage	10 V
VG1	$-4\text{ V} < V_{G1} < 0\text{ V}$
VG2	$-3.5\text{ V} < V_{G2} < +4\text{ V}$
Drain Supply Current	340 mA
Junction Temperature <sup>8,9</sup>	$+150\text{ }^\circ\text{C}$
Operating Temperature	$-40\text{ }^\circ\text{C}$ to $+85\text{ }^\circ\text{C}$
Storage Temperature	$-65\text{ }^\circ\text{C}$ to $+150\text{ }^\circ\text{C}$

- Exceeding any one or combination of these limits may cause permanent damage to this device.
- MACOM does not recommend sustained operation near these survivability limits.
- Operating at nominal conditions with  $T_J \leq +150\text{ }^\circ\text{C}$  will ensure  $MTTF > 1 \times 10^6$  hours.
- Junction Temperature ( $T_J$ ) =  $T_A + \Theta_{JC} * ((V * I) - (P_{OUT} - P_{IN}))$   
Typical thermal resistance ( $\Theta_{JC}$ ) =  $15.6\text{ }^\circ\text{C/W}$ .

### Handling Procedures

Please observe the following precautions to avoid damage:

### Static Sensitivity

These electronic devices are sensitive to electrostatic discharge (ESD) and can be damaged by static electricity. Proper ESD control techniques should be used when handling these HBM Class 1A devices.

### Operating Conditions

The recommended biasing conditions are  $V_{DD} = 7\text{ V}$  and  $I_{DSQ} = 200\text{ mA}$ , with  $I_{DSQ}$  set by adjusting  $V_{G1}$  after correctly setting  $V_{DD}$  (refer to turn on sequence). To maintain the best performance MACOM recommends using an active bias circuit for constant  $I_{DD}$ .

It is noted that any biasing arrangement used, including active biasing, must be able to source at least 10 mA into the  $V_{G1}$  port. This is because the  $V_{G1}$  port contains a resistive divider with a total resistance to ground of 244  $\Omega$ . For the recommended  $I_{DSQ}$  of 200 mA obtained at a  $V_{G1}$  voltage of around 2.5 V, 10 mA of  $V_{G1}$  current ( $I_{G1}$ ) is expected. These values of  $V_{G1}$  and  $I_{G1}$  will vary slightly between devices.

For biasing  $V_{DD}$ , apply  $V_{DD}$  through a bias tee connected to the  $RF_{OUT}/V_{DD}$  port and connect an external DC block to the  $RF_{IN}$  port. This provides wide band performance of 40 MHz to 50 GHz (depending on the bandwidth of the bias tee).

2 bypass capacitors of 100 pF and 1  $\mu\text{F}$  should be connected to  $V_{DAUX}$ . This provides for improved gain flatness below 2 GHz down to 30 kHz when required.

The 100 pF capacitor can be a single layer capacitor or an SMT device on the PCB. Although it should be positioned as closely to the device as practically possible, the frequency response is not particularly sensitive to this. The 1  $\mu\text{F}$  capacitor can be placed further away on the PCB.

Data in this datasheet was measured using 100 pF (C1) and 1  $\mu\text{F}$  (C3) capacitors on  $V_{DAUX}$ .

### Operating the MAAM-011275

#### Turn-on

1. Apply  $V_{G1}$  (-4 V).
2. Increase  $V_{DD}$  to +7 V.
3. Set  $I_{DSQ}$  by adjusting  $V_{G1}$  more positive. (typically -2.5 V for  $I_{DSQ} = 200\text{ mA}$ ).
4. Apply  $RF_{IN}$  signal.

#### Turn-off

1. Remove  $RF_{IN}$  signal.
2. Decrease  $V_{G1}$  to -4 V.
3. Decrease  $V_{DD}$  to 0 V.

Application Schematic

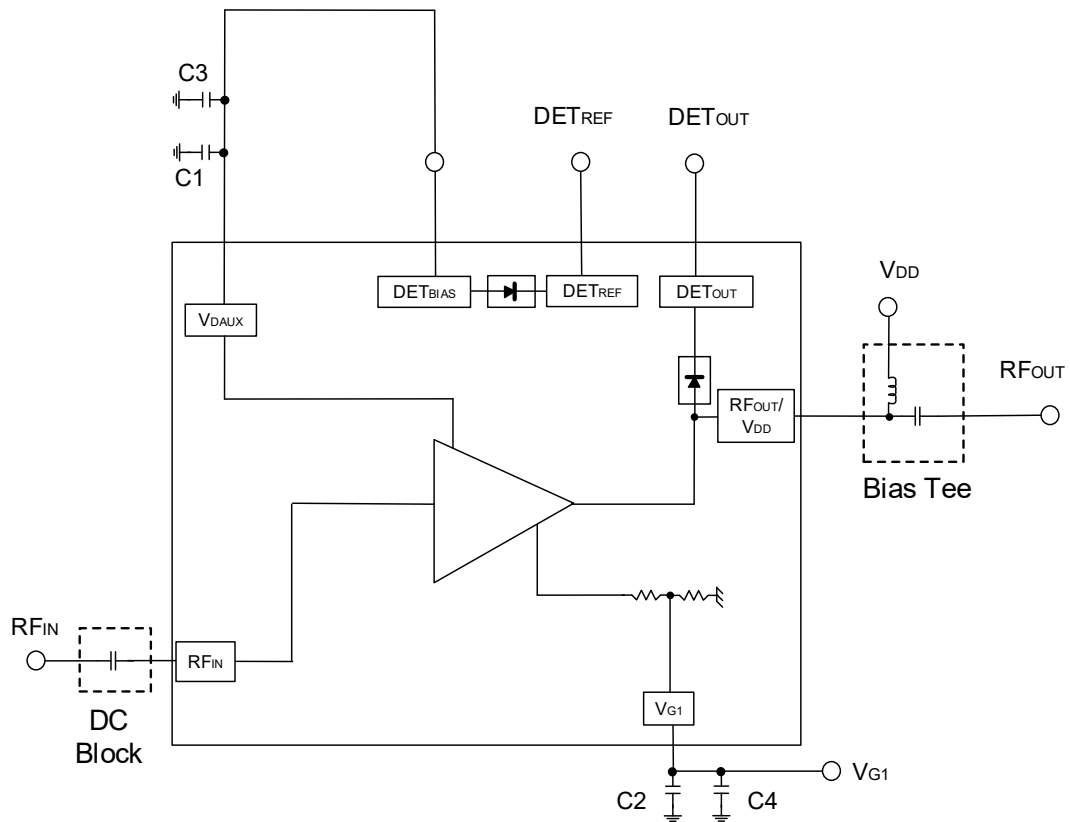

Component List

Part	Value	Size
C1, C2	0.01 $\mu$ F	0402
C3, C4	1 $\mu$ F	0603

# Wideband Distributed Amplifier

## 30 kHz - 50 GHz



MAAM-011275

Rev. V1

Typical Performance Curves:  $V_{DD} = 7\text{ V}$ ,  $I_{DSQ} = 200\text{ mA}$

**Gain**

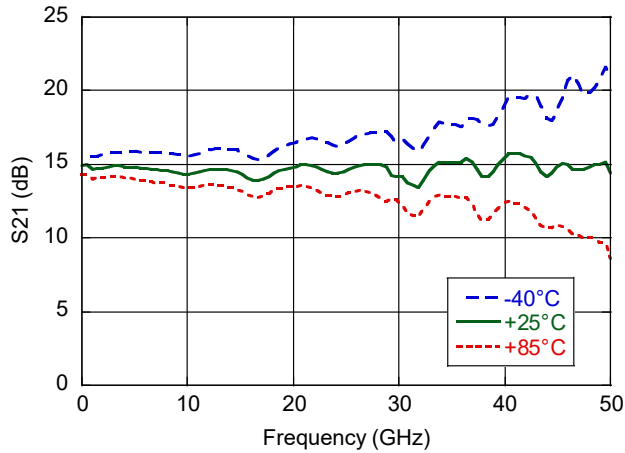

**Reverse Isolation**

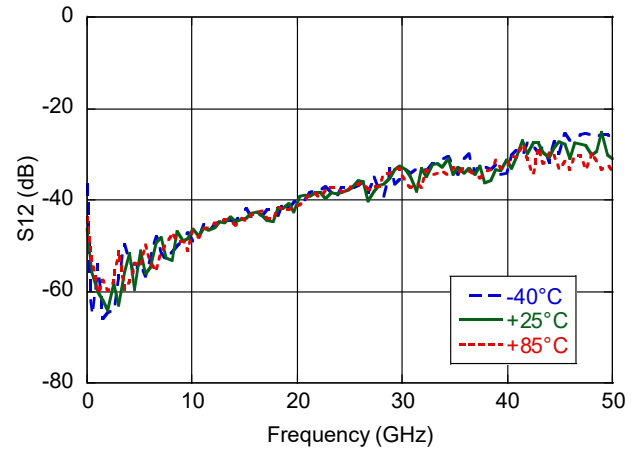

**Input Return Loss**

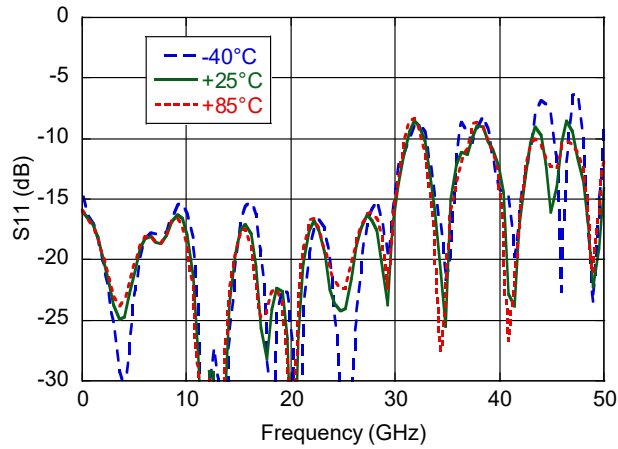

**Output Return Loss**

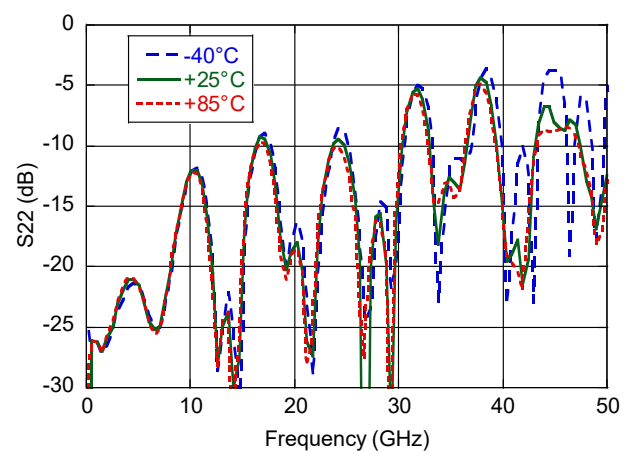

# Wideband Distributed Amplifier

## 30 kHz - 50 GHz



MAAM-011275

Rev. V1

Typical Performance Curves:  $V_{DD} = 7\text{ V}$ ,  $I_{DSQ} = 200\text{ mA}$

Output P1dB

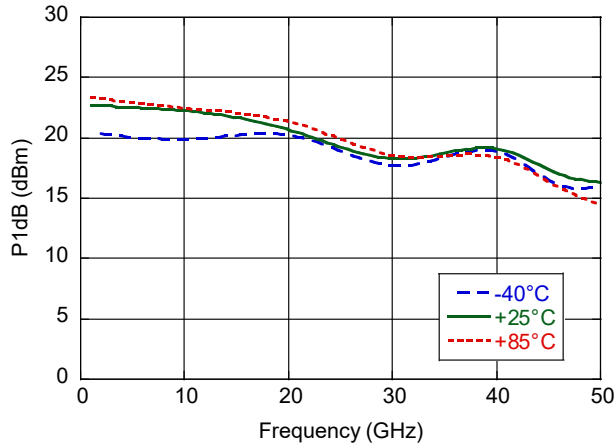

Output P3dB

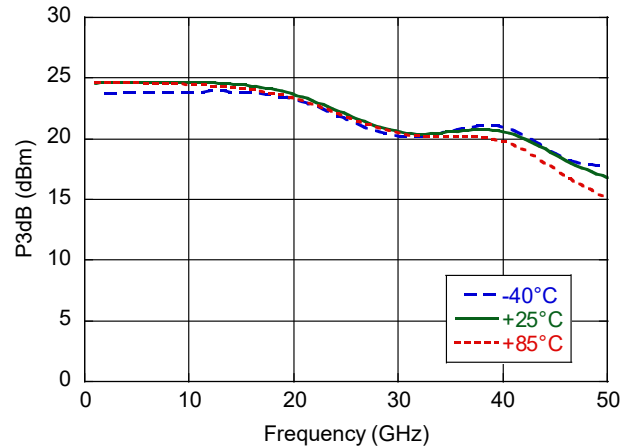

Noise Figure

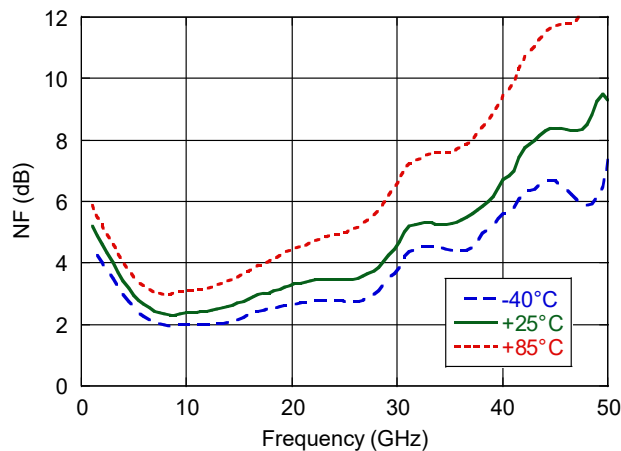

OIP3 @ Pin = -4 dBm

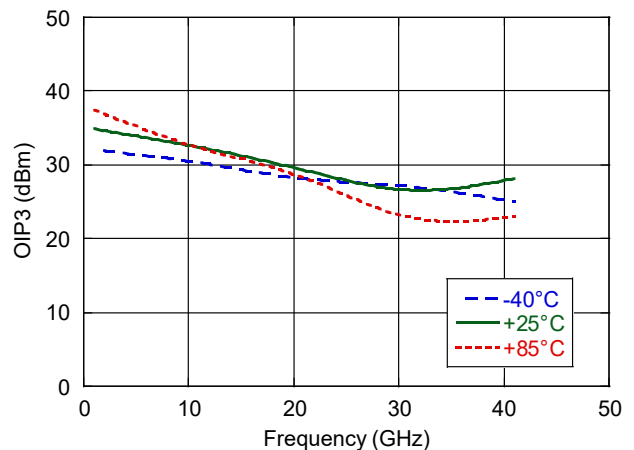

Detector Voltage @ +25°C

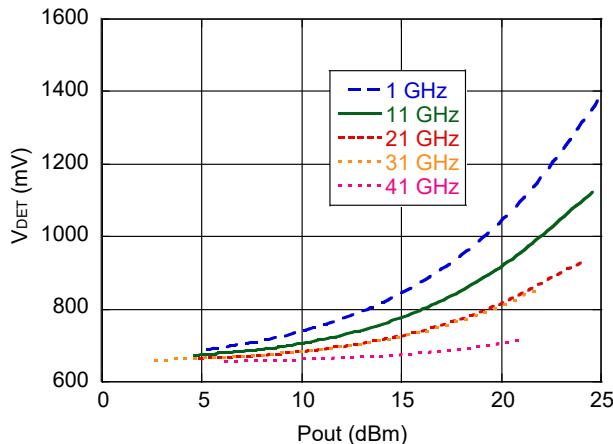

# Wideband Distributed Amplifier

## 30 kHz - 50 GHz



MAAM-011275

Rev. V1

### Typical Performance Curves: $T_A = +25^\circ\text{C}$

Output  $P_{1dB}$  vs.  $V_{DD}$

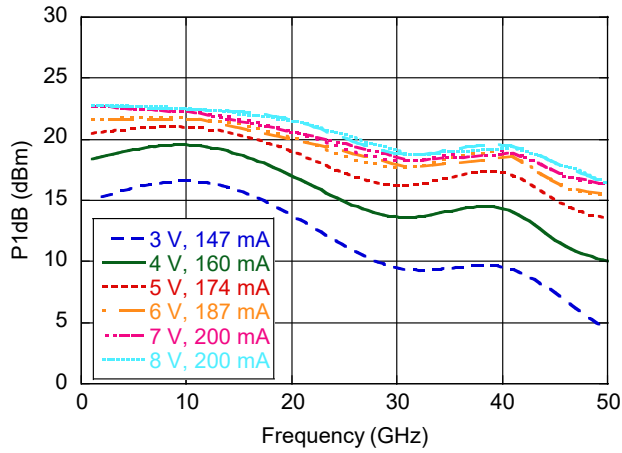

$P_{3dB}$  vs.  $V_{DD}$

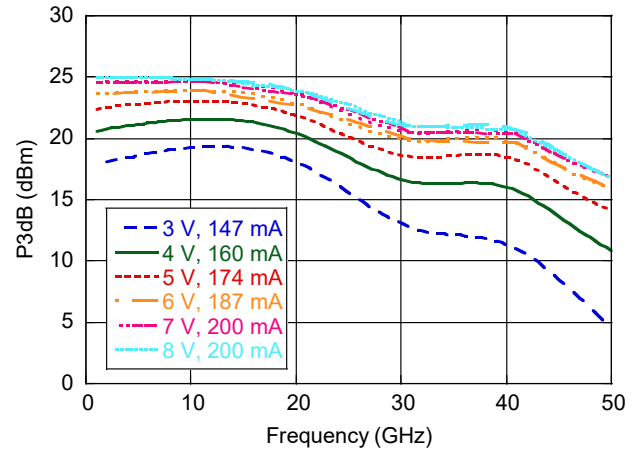

Gain vs.  $V_{DD}$

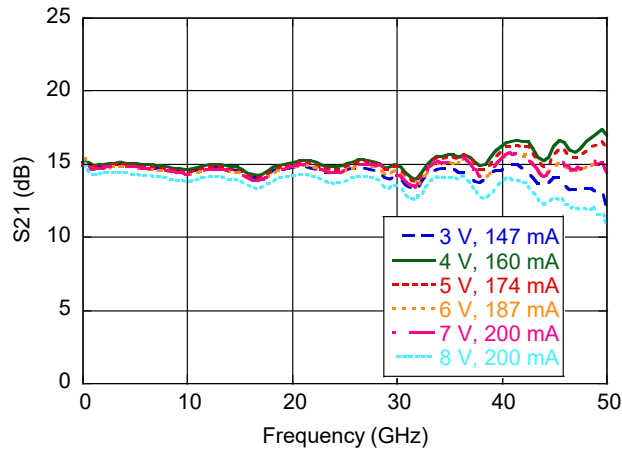

# Wideband Distributed Amplifier 30 kHz - 50 GHz



MAAM-011275

Rev. V1

## Typical Performance Curves: $V_{DD} = 7\text{ V}$ , $T_A = +25^\circ\text{C}$

Gain vs.  $I_{DD}$

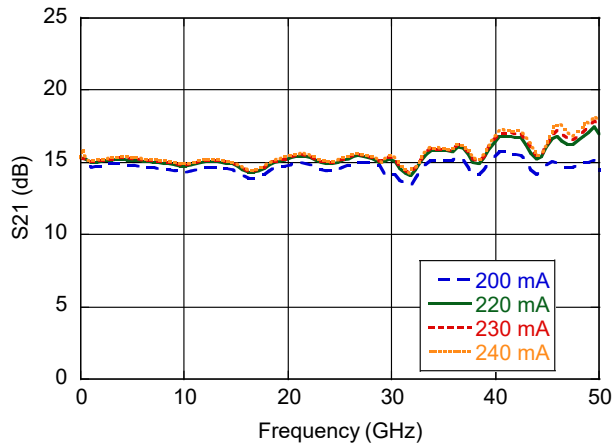

Reverse Isolation vs.  $I_{DD}$

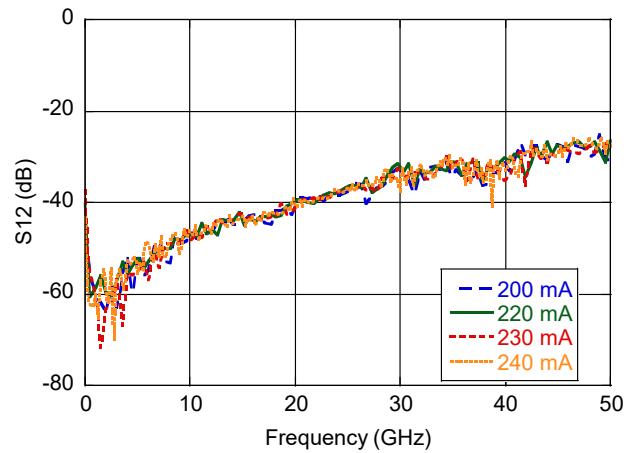

Input Return Loss vs.  $I_{DD}$

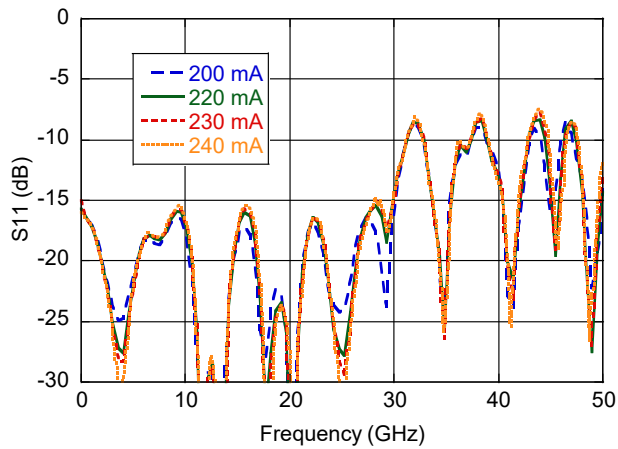

Output Return Loss vs.  $I_{DD}$

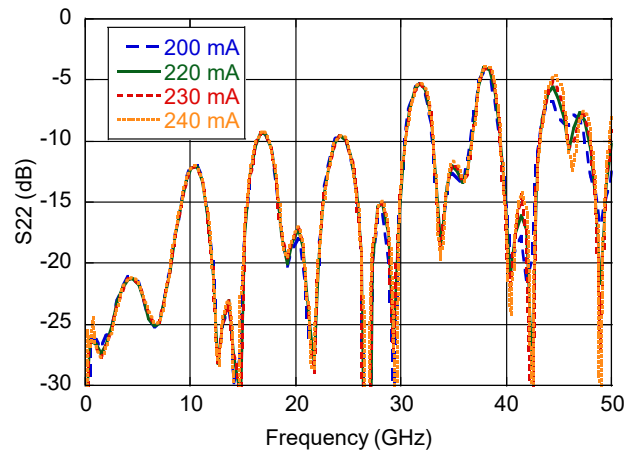



Recommended PCB Layout

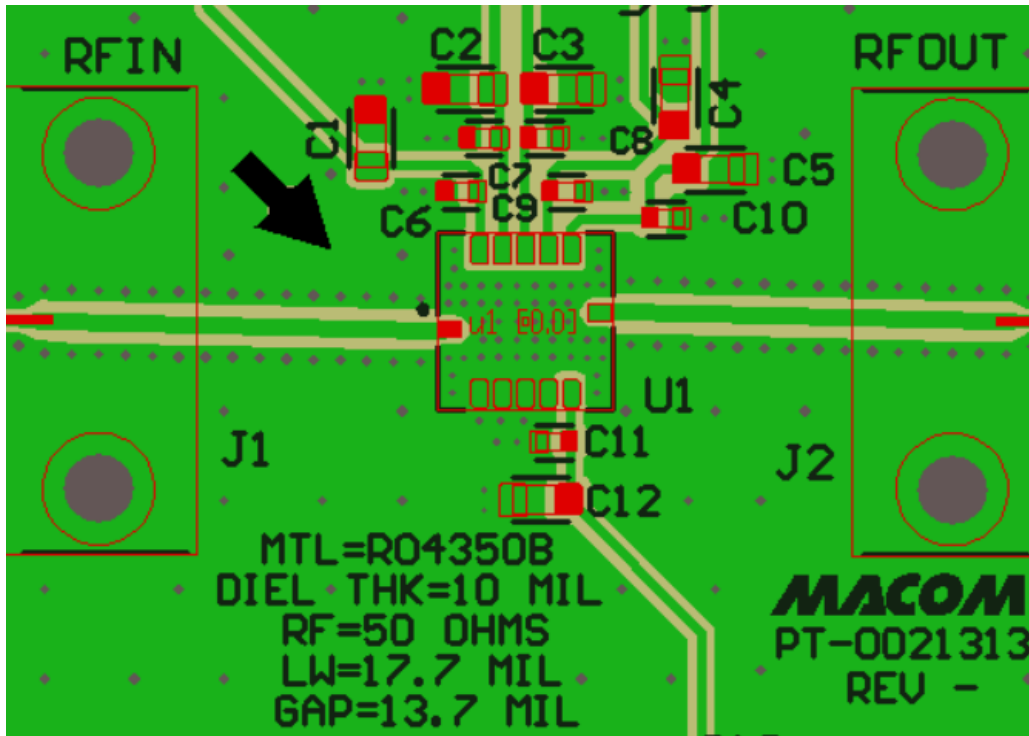

Evaluation Board Parts List

Part	Value	Case Style
C2, C12	1 $\mu$ F	0603
C7, C11	0.01 $\mu$ F	0402

Evaluation PCB Specifications<sup>10,11</sup>

Top Layer: 1 oz Copper Cladding  
Dielectric Layer: Rogers RO4350B 10 mil  
Bottom Layer: 1 oz Copper Cladding  
Finished overall thickness: 12.8 mil

- 10. PCB finish is ENEPIG. The vias located under the device are 8 mil in diameter and filled with thermally conductive material, capped over and planarized
- 11. Evaluation board should be mounted on a heat sink.



MACOM Technology Solutions Inc. ("MACOM"). All rights reserved.

These materials are provided in connection with MACOM's products as a service to its customers and may be used for informational purposes only. Except as provided in its Terms and Conditions of Sale or any separate agreement, MACOM assumes no liability or responsibility whatsoever, including for (i) errors or omissions in these materials; (ii) failure to update these materials; or (iii) conflicts or incompatibilities arising from future changes to specifications and product descriptions, which MACOM may make at any time, without notice. These materials grant no license, express or implied, to any intellectual property rights.

THESE MATERIALS ARE PROVIDED "AS IS" WITH NO WARRANTY OR LIABILITY, EXPRESS OR IMPLIED, RELATING TO SALE AND/OR USE OF MACOM PRODUCTS INCLUDING FITNESS FOR A PARTICULAR PURPOSE, MERCHANTABILITY, INFRINGEMENT OF INTELLECTUAL PROPERTY RIGHT, ACCURACY OR COMPLETENESS, OR SPECIAL, INDIRECT, INCIDENTAL, OR CONSEQUENTIAL DAMAGES WHICH MAY RESULT FROM USE OF THESE MATERIALS.

MACOM products are not intended for use in medical, lifesaving or life sustaining applications. MACOM customers using or selling MACOM products for use in such applications do so at their own risk and agree to fully indemnify MACOM for any damages resulting from such improper use or sale.