

THIS DRAWING IS UNPUBLISHED. RELEASED FOR PUBLICATION
 © COPYRIGHT ALL RIGHTS RESERVED.

LOC	DIST	REVISIONS					
HB		P	LTR	DESCRIPTION	DATE	DWN	APVD
		D		TE LOGO CHANGE; TERMINALS TOLERANCE CLARIFICATION	ECD-18-008295	30-MAY-18	TDD K.T

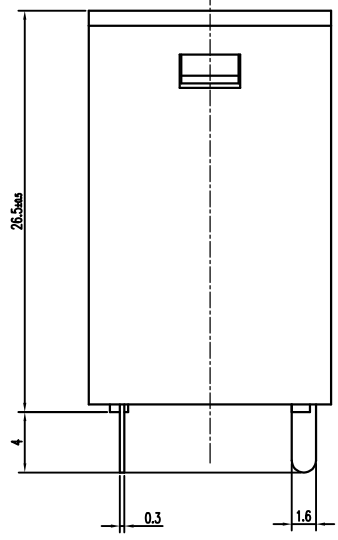

CIRCUIT DIAGRAM(BOTTON VIEW) DRILLING DIAGRAM (BOTTOM VIEW)

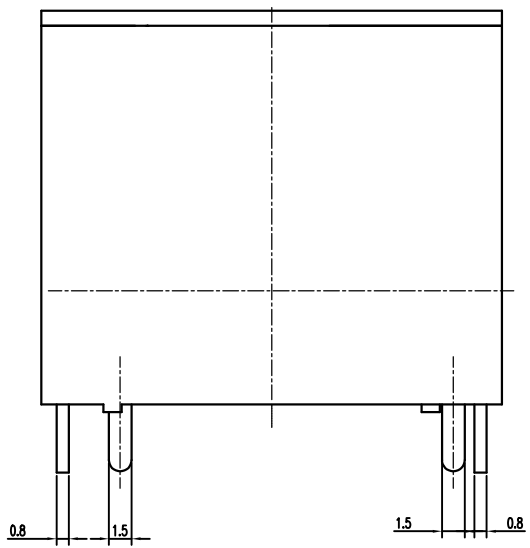
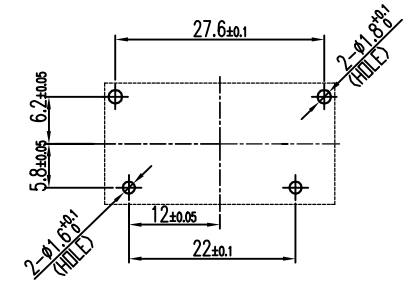
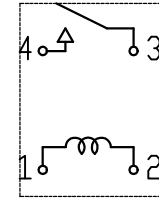

"C"

VIEW C

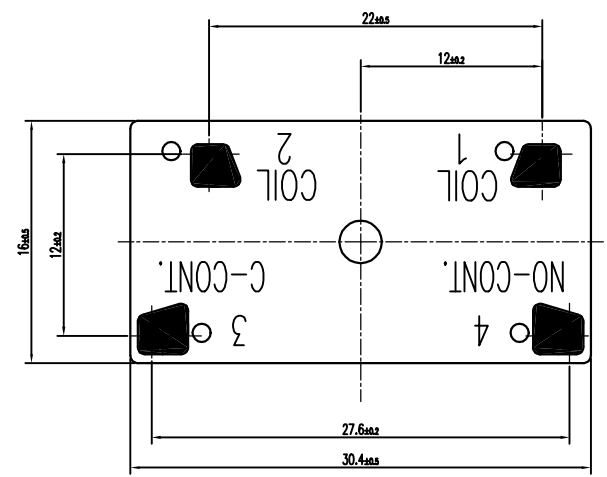
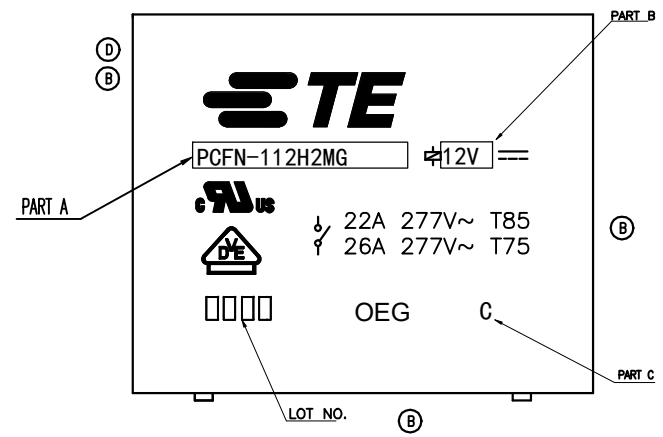

DIMENSIONS: mm 		TOLERANCES UNLESS OTHERWISE SPECIFIED: 0 PLC ± 1 PLC ±0.1 2 PLC ± 3 PLC ± 4 PLC ±		DWG BY.FENG CHK BH.YU APVD SN.ZHANG PRODUCT SPEC APPLICATION SPEC WEIGHT		TE Connectivity			
MATERIAL SEE MATERIAL TABLE		FINISH		SIZE A3 GAGE CODE 00779 DRAWING NO. C= 1721929		RESTRICT TO		CUSTOMER DRAWING	
				SCALE 3:1		SHEET 1 OF 2		REV D	

8 7 6 5 4 3 2 1

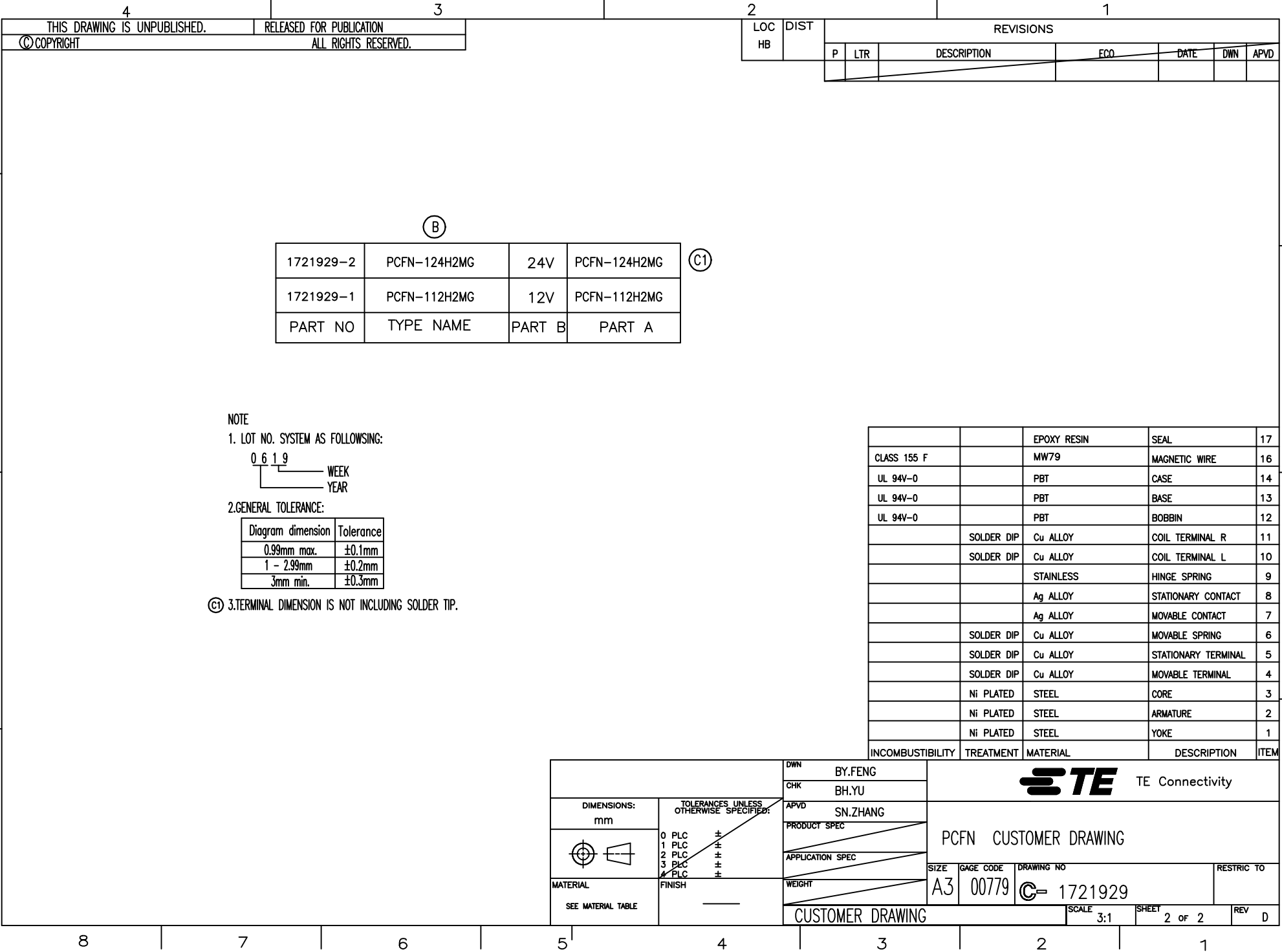

THIS DRAWING IS UNPUBLISHED. RELEASED FOR PUBLICATION
 © COPYRIGHT ALL RIGHTS RESERVED.

LOC HB	DIST	REVISIONS						
		P	LTR	DESCRIPTION	ECO	DATE	DWN	APVD

PART NO	TYPE NAME	PART B	PART A
1721929-2	PCFN-124H2MG	24V	PCFN-124H2MG
1721929-1	PCFN-112H2MG	12V	PCFN-112H2MG

NOTE
 1. LOT NO. SYSTEM AS FOLLOWSING:
 0 6 1 9
 WEEK
 YEAR

2. GENERAL TOLERANCE:

Diagram dimension	Tolerance
0.99mm max.	±0.1mm
1 - 2.99mm	±0.2mm
3mm min.	±0.3mm

3. TERMINAL DIMENSION IS NOT INCLUDING SOLDER TIP.

	EPOXY RESIN	SEAL	17	
CLASS 155 F	MW79	MAGNETIC WIRE	16	
UL 94V-0	PBT	CASE	14	
UL 94V-0	PBT	BASE	13	
UL 94V-0	PBT	BOBBIN	12	
	SOLDER DIP	Cu ALLOY	COIL TERMINAL R	11
	SOLDER DIP	Cu ALLOY	COIL TERMINAL L	10
	STAINLESS		HINGE SPRING	9
	Ag ALLOY		STATIONARY CONTACT	8
	Ag ALLOY		MOVABLE CONTACT	7
	SOLDER DIP	Cu ALLOY	MOVABLE SPRING	6
	SOLDER DIP	Cu ALLOY	STATIONARY TERMINAL	5
	SOLDER DIP	Cu ALLOY	MOVABLE TERMINAL	4
	Ni PLATED	STEEL	CORE	3
	Ni PLATED	STEEL	ARMATURE	2
	Ni PLATED	STEEL	YOKE	1
INCOMBUSTIBILITY TREATMENT	MATERIAL	DESCRIPTION	ITEM	

DWN	BY.FENG		
CHK	BH.YU		
APVD	SN.ZHANG	PCFN CUSTOMER DRAWING	
PRODUCT SPEC			
APPLICATION SPEC			
WEIGHT			
MATERIAL	FINISH		
SEE MATERIAL TABLE			
SIZE	GAGE CODE	DRAWING NO	RESTRICT TO
A3	00779	1721929	
CUSTOMER DRAWING		SCALE 3:1	SHEET 2 of 2
			REV D