

**Data sheet | Item number: 880-907/999-940**

2-conductor ground terminal block; 4 mm<sup>2</sup>; side and center marking; for DIN-rail 35 x 15 and 35 x 7.5; CAGE CLAMP®; 4,00 mm<sup>2</sup>; green-yellow

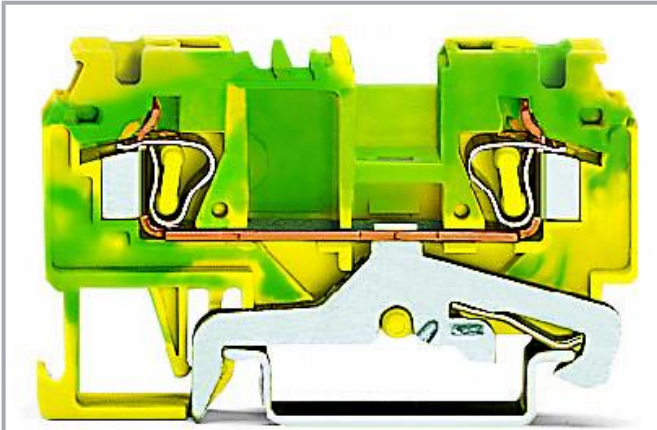

[www.wago.com/880-907/999-940](http://www.wago.com/880-907/999-940)



**i** Picture differs from the item.

Color:

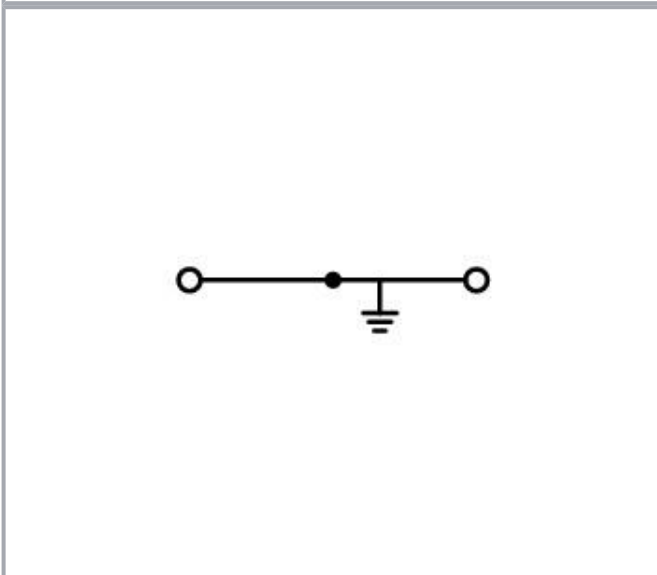
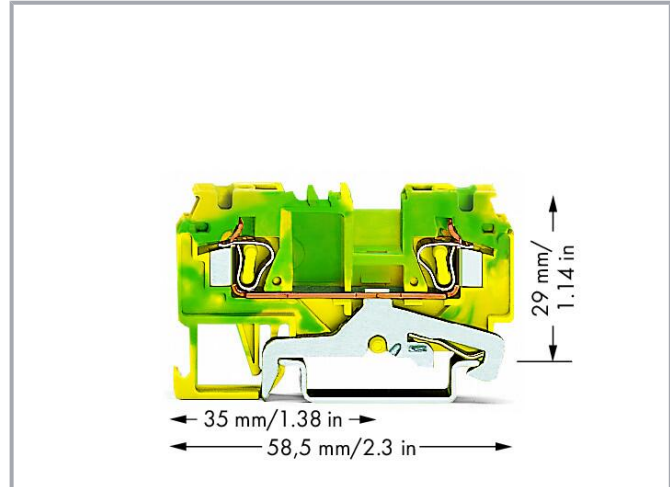

**Data**

**Electrical data**

Subject to changes. Please also observe the further product documentation!

WAGO GmbH & Co. KG  
Hansastr. 27  
32423 Minden  
Phone: +49571 887-0 | Fax: +49571 887-169  
Email: [info.de@wago.com](mailto:info.de@wago.com) | Web: [www.wago.com](http://www.wago.com)

Do you have any questions about our products?  
We are always happy to take your call at +49 (571) 887-44222.

## Ratings per IEC/EN

|             |                  |
|-------------|------------------|
| Ratings per | IEC/EN 60947-7-2 |
|-------------|------------------|

## Connection data

|                            |   |
|----------------------------|---|
| Connection points          | 2 |
| Total number of potentials | 1 |
| Number of levels           | 1 |

## Connection 1

|                                 |  |
|---------------------------------|--|
| Connection technology           | CAGE CLAMP®                                |
| Actuation type                  | Operating tool                             |
| Connectable conductor materials | Copper                                     |
| Solid conductor                 | 0.08 ... 4 mm <sup>2</sup> / 28 ... 12 AWG |
| Fine-stranded conductor         | 0.08 ... 4 mm <sup>2</sup> / 28 ... 12 AWG |
| Strip length                    | 8 ... 9 mm / 0.31 ... 0.35 inches          |
| Wiring direction                | Front-entry wiring                         |

## Physical data

|                                   |                        |
|-----------------------------------|------------------------|
| Width                             | 5 mm / 0.197 inches    |
| Height                            | 58.5 mm / 2.303 inches |
| Depth from upper-edge of DIN-rail | 29 mm / 1.142 inches   |

## Mechanical Data

|               |                     |
|---------------|---------------------|
| Design        | horizontal type     |
| Mounting type | DIN-35 rail         |
| Marking level | Center/side marking |

## Material Data

|                             |  |
|-----------------------------|--|
| Note (material data)        | Information on material specifications can be found here |
| Color                       | green-yellow   |
| Material group              | I  |
| Insulation material         | Polyamide (PA66)   |
| Flammability class per UL94 | V0   |

Subject to changes. Please also observe the further product documentation!



|           |          |
|-----------|----------|
| Fire load | 0.093 MJ |
| Weight    | 9.7 g    |

### Environmental requirements

|                                  |                 |
|----------------------------------|-----------------|
| Processing temperature           | -35 ... +85 °C  |
| Continuous operating temperature | -60 ... +105 °C |

### Commercial data

|                       |               |
|-----------------------|---------------|
| eCl@ss 10.0           | 27-14-11-41   |
| eCl@ss 9.0            | 27-14-11-41   |
| ETIM 8.0              | EC000901      |
| ETIM 7.0              | EC000901      |
| PU (SPU)              | 100 pcs       |
| Packaging type        | box           |
| Country of origin     | DE            |
| GTIN                  | 4045454121181 |
| Customs tariff number | 85369010000   |

### Environmental Product Compliance

|   |                                      |
|---|--------------------------------------|
| CAS-No.                                   | 7439-92-1                            |
| REACH Candidate List Substance            | Lead                                 |
| RoHS Compliance Status                    | Compliant,With Exemption             |
| RoHS Exemption                            | 6(c)<br>7(a)<br>7(c)-I<br>7(c)-II    |
| SCIP notification number (Austria)        | 1856b1b2-4213-43fd-ac7f-b54255b217b5 |
| SCIP notification number (Belgium)        | cb11f640-6c7b-4678-92d2-f76163d1e64d |
| SCIP notification number (Bulgaria)       | 3ae2221b-604f-45d7-a4f7-e8d875d5c03e |
| SCIP notification number (Czech Republic) | 141dbc02-9cd9-4aaf-b238-5a9f2e65973a |
| SCIP notification number (Denmark)        | 6b38e77b-13bb-436c-9ad0-eb2cf33678ca |
| SCIP notification number (Finland)        | f449ebcd-60b9-47ab-a625-988fa0ca89fa |
| SCIP notification number (France)         | 3d0db3d3-b463-4472-adb6-73d525a30032 |
| SCIP notification number (Germany)        | 25e7f783-1d5e-4d1e-a0bf-cf9ee51581c6 |
| SCIP notification number (Hungary)        | 7f98b7bd-d68b-48d6-acdc-9e167f6d1f9e |
| SCIP notification number (Italy)          | e40bfb7d-ed37-462a-8224-923f1c15380f |
| SCIP notification number (Netherlands)    | 36cd4b65-fe98-4a8f-b6e9-c7fd23c839f7 |

Subject to changes. Please also observe the further product documentation!



WAGO GmbH & Co. KG  
Hansastr. 27  
32423 Minden  
Phone: +49571 887-0 | Fax: +49571 887-169  
Email: [info.de@wago.com](mailto:info.de@wago.com) | Web: [www.wago.com](http://www.wago.com)

Do you have any questions about our products?  
We are always happy to take your call at +49 (571) 887-44222.



|                                    |                                      |
|------------------------------------|--------------------------------------|
| SCIP notification number (Poland)  | c95f100a-7d84-4b57-b9f1-815aa2415722 |
| SCIP notification number (Romania) | e4a2c106-3bbe-4f3f-b731-fbfe5a0724dc |
| SCIP notification number (Sweden)  | 09534734-8683-4090-91db-15090254c760 |

## Approvals / Certificates

### General approvals

| Logo   | Approval                             | Additional Approval Text | Certificate name |
|--|--------------------------------------|--------------------------|------------------|
|  | CCA<br>DEKRA Certification B.V.      | EN 60947                 | NTR-NL<br>7339   |
|  | CCA<br>DEKRA Certification B.V.      | EN 60947                 | 2174152.01       |
|  | UL<br>Underwriters Laboratories Inc. | UL 1059                  | E45172           |

### Declarations of conformity and manufacturer's declarations

| Logo   | Approval   | Additional Approval Text | Certificate name |
|--|--|--------------------------|------------------|
|  | EU-Declaration of Conformity<br>WAGO GmbH & Co. KG | -                        | -                |
|  | UK-Declaration of Conformity<br>WAGO GmbH & Co. KG | -                        | -                |

### Approvals for marine applications

| Logo   | Approval   | Additional Approval Text | Certificate name         |
|--|--|--------------------------|--------------------------|
|  | ABS<br>American Bureau of Shipping               | EN 60947                 | 20-<br>HG1941090-<br>PDA |
|  | DNV GL<br>Det Norske Veritas, Germanischer Lloyd | -                        | TAE00001V2               |

Subject to changes. Please also observe the further product documentation!



### Approvals for hazardous areas

| Logo   | Approval                               | Additional Approval Text | Certificate name                                      |
|--|--|--------------------------|---|
|  | EAC<br>Brjansker Zertifizierungsstelle | TP TC 012/2011           | RU C-DE.<br>AM02.B.<br>00127/19<br>(Ex e IIC<br>Gb U) |





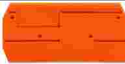

### Required accessories

#### End plate













| End plate   |   |  |
|---|---|--|
|   | Item no.: 880-325<br>End and intermediate plate; 2.5 mm thick; gray   | <a href="http://www.wago.com/880-325">www.wago.com/880-325</a> |
|  | Item no.: 880-328<br>End and intermediate plate; 2.5 mm thick; orange | <a href="http://www.wago.com/880-328">www.wago.com/880-328</a> |

### Optional accessories

#### Testing and measuring

| Testing accessories  |  |  |
|--|--|--|
|   | Item no.: 209-170<br>Test plug adapter; 8.3 mm wide; for 4 mm Ø test plugs; suitable for 1.5 mm <sup>2</sup> - 10 mm <sup>2</sup> tbs; gray                      | <a href="http://www.wago.com/209-170">www.wago.com/209-170</a> |
|  | Item no.: 210-136<br>Test plug; 2 mm Ø; with 500 mm cable; red   | <a href="http://www.wago.com/210-136">www.wago.com/210-136</a> |
|   | Item no.: 281-407<br>Test plug; 6 mm wide; Nominal current 24 A; for 0.08 mm <sup>2</sup> - 2.5 mm <sup>2</sup> ; 2,50 mm <sup>2</sup> ; gray                    | <a href="http://www.wago.com/281-407">www.wago.com/281-407</a> |
|   | Item no.: 249-106<br>B-type test plug module; modular; 1,50 mm <sup>2</sup> ; gray   | <a href="http://www.wago.com/249-106">www.wago.com/249-106</a> |
|   | Item no.: 249-107<br>B-type spacer module; modular; e.g., for bridging commoned terminal blocks; gray  | <a href="http://www.wago.com/249-107">www.wago.com/249-107</a> |
|   | Item no.: 280-418<br>Test plug module; modular; suitable for all WAGO 280 and 780 Series rail-mounted terminal blocks with jumper slots in the current bar; gray | <a href="http://www.wago.com/280-418">www.wago.com/280-418</a> |

Subject to changes. Please also observe the further product documentation!

|  |  |  |
|--|--|--|
|     | <b>Item no.: 280-404</b><br>Test plug adapter; 5 mm wide; for test plug (2.3 mm Ø); suitable for 1.5 mm <sup>2</sup> - 4 mm <sup>2</sup> tbs; gray | <a href="http://www.wago.com/280-404">www.wago.com/280-404</a>                   |
|     | <b>Item no.: 280-419</b><br>Spacer module; modular; bridging commoned terminal blocks; gray  | <a href="http://www.wago.com/280-419">www.wago.com/280-419</a>                   |
| <b>Push-in type wire jumper</b>  |  |  |
| Jumper   |  |  |
|    | <b>Item no.: 249-123</b><br>Push-in type wire jumper; 0.75 mm <sup>2</sup> ; insulated; 180 mm long; black   | <a href="http://www.wago.com/249-123">www.wago.com/249-123</a>                   |
|    | <b>Item no.: 249-126</b><br>Push-in type wire jumper; 0.75 mm <sup>2</sup> ; insulated; 110 mm long; black   | <a href="http://www.wago.com/249-126">www.wago.com/249-126</a>                   |
|    | <b>Item no.: 249-127</b><br>Push-in type wire jumper; 0.75 mm <sup>2</sup> ; insulated; 250 mm long; black   | <a href="http://www.wago.com/249-127">www.wago.com/249-127</a>                   |
|    | <b>Item no.: 249-125</b><br>Push-in type wire jumper; insulated; 60 mm long; black   | <a href="http://www.wago.com/249-125">www.wago.com/249-125</a>                   |
| <b>Insulation stop</b>   |  |  |
| Insulation stop  |  |  |
|    | <b>Item no.: 280-472</b><br>Insulation stop; 0.75 - 1 mm <sup>2</sup> ; 5 pieces/strip; black  | <a href="http://www.wago.com/280-472">www.wago.com/280-472</a>                   |
|   | <b>Item no.: 280-470</b><br>Insulation stop; 0.08 - 0.2 mm <sup>2</sup> "s" (0.14 mm <sup>2</sup> "f-st"); 5 pieces/strip; white                   | <a href="http://www.wago.com/280-470">www.wago.com/280-470</a>                   |
|  | <b>Item no.: 280-471</b><br>Insulation stop; 0.25 - 0.5 mm <sup>2</sup> ; 5 pieces/strip; light gray   | <a href="http://www.wago.com/280-471">www.wago.com/280-471</a>                   |
| <b>Marking accessories</b>   |  |  |
| Marker   |  |  |
|  | <b>Item no.: 2009-115/000-002</b><br>WMB-Inline; for Smart Printer; 1500 pieces on roll; stretchable 5 - 5.2 mm; plain; snap-on type; yellow       | <a href="http://www.wago.com/2009-115/000-002">www.wago.com/2009-115/000-002</a> |
|  | <b>Item no.: 2009-115/000-007</b><br>WMB-Inline; for Smart Printer; 1500 pieces on roll; stretchable 5 - 5.2 mm; plain; snap-on type; gray         | <a href="http://www.wago.com/2009-115/000-007">www.wago.com/2009-115/000-007</a> |
|  | <b>Item no.: 2009-115/000-017</b><br>WMB-Inline; for Smart Printer; 1500 pieces on roll; stretchable 5 - 5.2 mm; plain; snap-on type; light green  | <a href="http://www.wago.com/2009-115/000-017">www.wago.com/2009-115/000-017</a> |
|  | <b>Item no.: 2009-115/000-023</b><br>WMB-Inline; for Smart Printer; 1500 pieces on roll; stretchable 5 - 5.2 mm; plain; snap-on type; green        | <a href="http://www.wago.com/2009-115/000-023">www.wago.com/2009-115/000-023</a> |

Subject to changes. Please also observe the further product documentation!



Item no.: 2009-115/000-024

WMB-Inline; for Smart Printer; 1500 pieces on roll; stretchable 5 - 5.2 mm; plain; snap-on type; violet

[www.wago.com/2009-115/000-024](http://www.wago.com/2009-115/000-024)

Item no.: 2009-145/000-006

Mini-WSB Inline; for Smart Printer; 1700 pieces on roll; stretchable 5 - 5.2 mm; plain; snap-on type; blue

[www.wago.com/2009-145/000-006](http://www.wago.com/2009-145/000-006)

Item no.: 2009-145

Mini-WSB Inline; for Smart Printer; 1700 pieces on roll; stretchable 5 - 5.2 mm; plain; snap-on type; white

[www.wago.com/2009-145](http://www.wago.com/2009-145)

Item no.: 2009-145/000-002

Mini-WSB Inline; for Smart Printer; 1700 pieces on roll; stretchable 5 - 5.2 mm; plain; snap-on type; yellow

[www.wago.com/2009-145/000-002](http://www.wago.com/2009-145/000-002)

Item no.: 2009-145/000-007

Mini-WSB Inline; for Smart Printer; 1700 pieces on roll; stretchable 5 - 5.2 mm; plain; snap-on type; gray

[www.wago.com/2009-145/000-007](http://www.wago.com/2009-145/000-007)

Item no.: 2009-145/000-005

Mini-WSB Inline; for Smart Printer; 1700 pieces on roll; stretchable 5 - 5.2 mm; plain; snap-on type; red

[www.wago.com/2009-145/000-005](http://www.wago.com/2009-145/000-005)

Item no.: 2009-145/000-012

Mini-WSB Inline; for Smart Printer; 1700 pieces on roll; stretchable 5 - 5.2 mm; plain; snap-on type; orange

[www.wago.com/2009-145/000-012](http://www.wago.com/2009-145/000-012)

Item no.: 2009-145/000-023

Mini-WSB Inline; for Smart Printer; 1700 pieces on roll; stretchable 5 - 5.2 mm; plain; snap-on type; green

[www.wago.com/2009-145/000-023](http://www.wago.com/2009-145/000-023)

Item no.: 2009-145/000-024

Mini-WSB Inline; for Smart Printer; 1700 pieces on roll; stretchable 5 - 5.2 mm; plain; snap-on type; violet

[www.wago.com/2009-145/000-024](http://www.wago.com/2009-145/000-024)



Item no.: 2009-115

WMB-Inline; for Smart Printer; 1500 pieces on roll; stretchable 5 - 5.2 mm; plain; snap-on type; white

[www.wago.com/2009-115](http://www.wago.com/2009-115)



Item no.: 248-501/000-006

Mini-WSB marking card; as card; not stretchable; plain; snap-on type; blue

[www.wago.com/248-501/000-006](http://www.wago.com/248-501/000-006)



Item no.: 248-501/000-007

Mini-WSB marking card; as card; not stretchable; plain; snap-on type; gray

[www.wago.com/248-501/000-007](http://www.wago.com/248-501/000-007)



Item no.: 248-501/000-002

Mini-WSB marking card; as card; not stretchable; plain; snap-on type; yellow

[www.wago.com/248-501/000-002](http://www.wago.com/248-501/000-002)

Subject to changes. Please also observe the further product documentation!

WAGO GmbH & Co. KG

Hansastr. 27

32423 Minden

Phone: +49571 887-0 | Fax: +49571 887-169

Email: [info.de@wago.com](mailto:info.de@wago.com) | Web: [www.wago.com](http://www.wago.com)

Do you have any questions about our products?

We are always happy to take your call at +49 (571) 887-44222.



**Item no.: 248-501/000-012**  
Mini-WSB marking card; as card; not stretchable; plain; snap-on type; orange

[www.wago.com/248-501/000-012](http://www.wago.com/248-501/000-012)



**Item no.: 248-501**  
Mini-WSB marking card; as card; not stretchable; plain; snap-on type; white

[www.wago.com/248-501](http://www.wago.com/248-501)



**Item no.: 248-501/000-017**  
Mini-WSB marking card; as card; not stretchable; plain; snap-on type; light green

[www.wago.com/248-501/000-017](http://www.wago.com/248-501/000-017)



**Item no.: 248-501/000-005**  
Mini-WSB marking card; as card; not stretchable; plain; snap-on type; red

[www.wago.com/248-501/000-005](http://www.wago.com/248-501/000-005)



**Item no.: 248-501/000-024**  
Mini-WSB marking card; as card; not stretchable; plain; snap-on type; violet

[www.wago.com/248-501/000-024](http://www.wago.com/248-501/000-024)



**Item no.: 248-501/000-023**  
Mini-WSB marking card; as card; not stretchable; plain; snap-on type; green

[www.wago.com/248-501/000-023](http://www.wago.com/248-501/000-023)

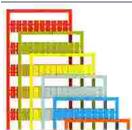

**Item no.: 793-5501/000-007**  
WMB marking card; as card; for terminal block width 5 - 17.5 mm; stretchable 5 - 5.2 mm; plain; snap-on type; gray

[www.wago.com/793-5501/000-007](http://www.wago.com/793-5501/000-007)



**Item no.: 793-5501/000-012**  
WMB marking card; as card; for terminal block width 5 - 17.5 mm; stretchable 5 - 5.2 mm; plain; snap-on type; orange

[www.wago.com/793-5501/000-012](http://www.wago.com/793-5501/000-012)



**Item no.: 793-5501/000-017**  
WMB marking card; as card; for terminal block width 5 - 17.5 mm; stretchable 5 - 5.2 mm; plain; snap-on type; light green

[www.wago.com/793-5501/000-017](http://www.wago.com/793-5501/000-017)



**Item no.: 793-5501/000-023**  
WMB marking card; as card; for terminal block width 5 - 17.5 mm; stretchable 5 - 5.2 mm; plain; snap-on type; green

[www.wago.com/793-5501/000-023](http://www.wago.com/793-5501/000-023)



**Item no.: 793-5501/000-024**  
WMB marking card; as card; for terminal block width 5 - 17.5 mm; stretchable 5 - 5.2 mm; plain; snap-on type; violet

[www.wago.com/793-5501/000-024](http://www.wago.com/793-5501/000-024)

Subject to changes. Please also observe the further product documentation!





**Item no.: 793-501/000-002**  
WMB marking card; as card; not stretchable; plain; snap-on type; yellow

[www.wago.com/793-501/000-002](http://www.wago.com/793-501/000-002)



**Item no.: 793-501/000-007**  
WMB marking card; as card; not stretchable; plain; snap-on type; gray

[www.wago.com/793-501/000-007](http://www.wago.com/793-501/000-007)



**Item no.: 793-501/000-017**  
WMB marking card; as card; not stretchable; plain; snap-on type; light green

[www.wago.com/793-501/000-017](http://www.wago.com/793-501/000-017)



**Item no.: 793-501/000-012**  
WMB marking card; as card; not stretchable; plain; snap-on type; orange

[www.wago.com/793-501/000-012](http://www.wago.com/793-501/000-012)



**Item no.: 793-501/000-023**  
WMB marking card; as card; not stretchable; plain; snap-on type; green

[www.wago.com/793-501/000-023](http://www.wago.com/793-501/000-023)



**Item no.: 793-501/000-006**  
WMB marking card; as card; not stretchable; plain; snap-on type; blue

[www.wago.com/793-501/000-006](http://www.wago.com/793-501/000-006)



**Item no.: 793-501/000-005**  
WMB marking card; as card; not stretchable; plain; snap-on type; red

[www.wago.com/793-501/000-005](http://www.wago.com/793-501/000-005)



**Item no.: 793-501**  
WMB marking card; as card; not stretchable; plain; snap-on type; white

[www.wago.com/793-501](http://www.wago.com/793-501)

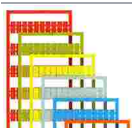

**Item no.: 793-501/000-024**  
WMB marking card; as card; not stretchable; plain; snap-on type; violet

[www.wago.com/793-501/000-024](http://www.wago.com/793-501/000-024)

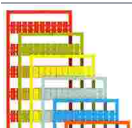

**Item no.: 793-5501/000-005**  
WMB marking card; as card; for terminal block width 5 - 17.5 mm; stretchable 5 - 5.2 mm; plain; snap-on type; red

[www.wago.com/793-5501/000-005](http://www.wago.com/793-5501/000-005)

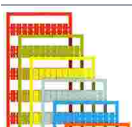

**Item no.: 793-5501/000-002**  
WMB marking card; as card; for terminal block width 5 - 17.5 mm; stretchable 5 - 5.2 mm; plain; snap-on type; yellow

[www.wago.com/793-5501/000-002](http://www.wago.com/793-5501/000-002)

Subject to changes. Please also observe the further product documentation!



**Item no.:** 793-5501/000-006

WMB marking card; as card; for terminal block width 5 - 17.5 mm; stretchable 5 - 5.2 mm; plain; snap-on type; blue [www.wago.com/793-5501/000-006](http://www.wago.com/793-5501/000-006)



**Item no.:** 793-5501

WMB marking card; as card; for terminal block width 5 - 17.5 mm; stretchable 5 - 5.2 mm; plain; snap-on type; white [www.wago.com/793-5501](http://www.wago.com/793-5501)



**Item no.:** 2009-115/000-012

WMB-Inline; for Smart Printer; 1500 pieces on roll; stretchable 5 - 5.2 mm; plain; snap-on type; orange [www.wago.com/2009-115/000-012](http://www.wago.com/2009-115/000-012)



**Item no.:** 2009-115/000-006

WMB-Inline; for Smart Printer; 1500 pieces on roll; stretchable 5 - 5.2 mm; plain; snap-on type; blue [www.wago.com/2009-115/000-006](http://www.wago.com/2009-115/000-006)

Group marker carrier



**Item no.:** 249-105

Group marker carrier; gray [www.wago.com/249-105](http://www.wago.com/249-105)

Jumpers

Jumper



**Item no.:** 210-123

Wire commoning chain; insulated; blue [www.wago.com/210-123](http://www.wago.com/210-123)



**Item no.:** 280-402

Jumper; insulated; gray [www.wago.com/280-402](http://www.wago.com/280-402)



**Item no.:** 210-103

Wire commoning chain; insulated; black [www.wago.com/210-103](http://www.wago.com/210-103)



**Item no.:** 280-409

Jumper; insulated; gray [www.wago.com/280-409](http://www.wago.com/280-409)



**Item no.:** 280-422

Jumper; insulated; yellow-green [www.wago.com/280-422](http://www.wago.com/280-422)



**Item no.:** 709-110

Wire commoning chain; 2.5 mm²; insulated; black [www.wago.com/709-110](http://www.wago.com/709-110)



**Item no.:** 709-112

Wire commoning chain; 2.5 mm²; insulated; black [www.wago.com/709-112](http://www.wago.com/709-112)



**Item no.:** 709-111

Wire commoning chain; 2.5 mm²; insulated; black [www.wago.com/709-111](http://www.wago.com/709-111)



**Item no.:** 780-454

Staggered jumper; from 1 to 4; insulated; gray [www.wago.com/780-454](http://www.wago.com/780-454)

Subject to changes. Please also observe the further product documentation!

WAGO GmbH & Co. KG

Hansastr. 27















32423 Minden

Phone: +49571 887-0 | Fax: +49571 887-169

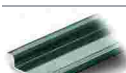
Email: [info.de@wago.com](mailto:info.de@wago.com) | Web: [www.wago.com](http://www.wago.com)

Do you have any questions about our products?

We are always happy to take your call at +49 (571) 887-44222.

|  |  |  |
|--|--|--|
|    | <b>Item no.: 780-452</b><br>Staggered jumper; from 1 to 2; insulated; gray   | <a href="http://www.wago.com/780-452">www.wago.com/780-452</a> |
|    | <b>Item no.: 780-453</b><br>Staggered jumper; from 1 to 3; insulated; gray   | <a href="http://www.wago.com/780-453">www.wago.com/780-453</a> |
|    | <b>Item no.: 780-457</b><br>Staggered jumper; from 1 to 7; insulated; gray   | <a href="http://www.wago.com/780-457">www.wago.com/780-457</a> |
|    | <b>Item no.: 780-456</b><br>Staggered jumper; from 1 to 6; insulated; gray   | <a href="http://www.wago.com/780-456">www.wago.com/780-456</a> |
|    | <b>Item no.: 780-455</b><br>Staggered jumper; from 1 to 5; insulated; gray   | <a href="http://www.wago.com/780-455">www.wago.com/780-455</a> |
|    | <b>Item no.: 780-458</b><br>Staggered jumper; from 1 to 8; insulated; gray   | <a href="http://www.wago.com/780-458">www.wago.com/780-458</a> |
| <b>Carrier rail</b>  |  |  |
| Mounting accessories   |  |  |
|    | <b>Item no.: 210-197</b><br>Steel carrier rail; 35 x 15 mm; 1.5 mm thick; 2 m long; slotted; similar to EN 60715; silver-colored                     | <a href="http://www.wago.com/210-197">www.wago.com/210-197</a> |
|    | <b>Item no.: 210-198</b><br>Copper carrier rail; 35 x 15 mm; 2.3 mm thick; 2 m long; unslotted; according to EN 60715; copper-colored                | <a href="http://www.wago.com/210-198">www.wago.com/210-198</a> |
|  | <b>Item no.: 210-504</b><br>Steel carrier rail; 35 x 7.5 mm; 1 mm thick; 2 m long; slotted; galvanized; according to EN 60715; silver-colored        | <a href="http://www.wago.com/210-504">www.wago.com/210-504</a> |
|  | <b>Item no.: 210-505</b><br>Steel carrier rail; 35 x 7.5 mm; 1 mm thick; 2 m long; unslotted; galvanized; according to EN 60715; silver-colored      | <a href="http://www.wago.com/210-505">www.wago.com/210-505</a> |
|  | <b>Item no.: 210-506</b><br>Steel carrier rail; 35 x 15 mm; 1.5 mm thick; 2 m long; unslotted; galvanized; similar to EN 60715; silver-colored       | <a href="http://www.wago.com/210-506">www.wago.com/210-506</a> |
|  | <b>Item no.: 210-508</b><br>Steel carrier rail; 35 x 15 mm; 1.5 mm thick; 2 m long; slotted; galvanized; similar to EN 60715; silver-colored         | <a href="http://www.wago.com/210-508">www.wago.com/210-508</a> |
|  | <b>Item no.: 210-113</b><br>Steel carrier rail; 35 x 7.5 mm; 1 mm thick; 2 m long; unslotted; according to EN 60715; silver-colored                  | <a href="http://www.wago.com/210-113">www.wago.com/210-113</a> |
|  | <b>Item no.: 210-118</b><br>Steel carrier rail; 35 x 15 mm; 2.3 mm thick; 2 m long; unslotted; according to EN 60715; silver-colored                 | <a href="http://www.wago.com/210-118">www.wago.com/210-118</a> |
|  | <b>Item no.: 210-112</b><br>Steel carrier rail; 35 x 7.5 mm; 1 mm thick; 2 m long; slotted; according to EN 60715; "Hole width 25 mm; silver-colored | <a href="http://www.wago.com/210-112">www.wago.com/210-112</a> |

Subject to changes. Please also observe the further product documentation!



**Item no.: 210-114**

Steel carrier rail; 35 x 15 mm; 1.5 mm thick; 2 m long; unslotted; similar to EN 60715; silver-colored

[www.wago.com/210-114](http://www.wago.com/210-114)



**Item no.: 210-115**

Steel carrier rail; 35 x 7.5 mm; 1 mm thick; 2 m long; slotted; according to EN 60715; "Hole width 18 mm; silver-colored

[www.wago.com/210-115](http://www.wago.com/210-115)



**Item no.: 210-196**

Aluminum carrier rail; 35 x 8.2 mm; 1.6 mm thick; 2 m long; unslotted; similar to EN 60715; silver-colored

[www.wago.com/210-196](http://www.wago.com/210-196)

**End plate**

End plate



**Item no.: 880-326**

Separator plate; 2 mm thick; oversized; gray

[www.wago.com/880-326](http://www.wago.com/880-326)



**Item no.: 880-329**

Separator plate; 2 mm thick; oversized; orange

[www.wago.com/880-329](http://www.wago.com/880-329)

**Protective warning marker**

Cover



**Item no.: 280-415**

Protective warning marker; for 5 terminal blocks; with high-voltage symbol, black; yellow

[www.wago.com/280-415](http://www.wago.com/280-415)

**Ferrule**

Ferrule



**Item no.: 216-206**

Ferrule; Sleeve for 2.5 mm<sup>2</sup> / AWG 14; insulated; electro-tin plated; blue

[www.wago.com/216-206](http://www.wago.com/216-206)

**Mounting**

Cover carrier



**Item no.: 709-167**

Cover carrier; Type 1; incl. fixing/retaining screws and knurled nut; suitable for 279 to 282 and 880 Series rail-mounted terminal blocks; suitable for 264 Series miniature rail-mounted terminal blocks; suitable for 270 Series sensor and actuator terminal blocks; gray

[www.wago.com/709-167](http://www.wago.com/709-167)

Cover



**Item no.: 709-153**

Cover; Type 1; suitable for cover carrier, type 1; 1 m long; transparent

[www.wago.com/709-153](http://www.wago.com/709-153)

Mounting accessories



**Item no.: 209-106**

Mounting carrier; for isolated mounting on DIN 35 rails; gray

[www.wago.com/209-106](http://www.wago.com/209-106)



**Item no.: 249-116**

Screwless end stop; 6 mm wide; for DIN-rail 35 x 15 and 35 x 7.5; gray

[www.wago.com/249-116](http://www.wago.com/249-116)

Subject to changes. Please also observe the further product documentation!

WAGO GmbH & Co. KG

Hansastr. 27

32423 Minden

Phone: +49571 887-0 | Fax: +49571 887-169

Email: [info.de@wago.com](mailto:info.de@wago.com) | Web: [www.wago.com](http://www.wago.com)

Do you have any questions about our products?

We are always happy to take your call at +49 (571) 887-44222.



## Downloads

### Documentation

#### Bid Text

|                                |             |               |          |
|--------------------------------|-------------|---------------|----------|
| 880-907/999-940<br>X81 - Datei | 2019 Feb 19 | xml<br>3.3 kB | Download |
|--------------------------------|-------------|---------------|----------|

|                                |             |                |          |
|--------------------------------|-------------|----------------|----------|
| 880-907/999-940<br>doc - Datei | 2017 Feb 28 | doc<br>24.6 kB | Download |
|--------------------------------|-------------|----------------|----------|

#### Additional Information

|   |  |               |          |
|---|--|---------------|----------|
| Technical Section<br>Technical explanations |  | pdf<br>2.2 MB | Download |
|---|--|---------------|----------|

## CAD/CAE-Data

### CAD data

|                              |  |     |          |
|------------------------------|--|-----|----------|
| 2D/3D Models 880-907/999-940 |  | URL | Download |
|------------------------------|--|-----|----------|

### CAE data

|                                   |  |     |          |
|-----------------------------------|--|-----|----------|
| EPLAN Data Portal 880-907/999-940 |  | URL | Download |
|-----------------------------------|--|-----|----------|

|                                |  |     |          |
|--------------------------------|--|-----|----------|
| WSCAD Universe 880-907/999-940 |  | URL | Download |
|--------------------------------|--|-----|----------|

|                                   |  |     |          |
|-----------------------------------|--|-----|----------|
| EPLAN Data Portal 880-907/999-940 |  | URL | Download |
|-----------------------------------|--|-----|----------|

|                              |  |     |          |
|------------------------------|--|-----|----------|
| ZUKEN Portal 880-907/999-940 |  | URL | Download |
|------------------------------|--|-----|----------|

|                                |  |     |          |
|--------------------------------|--|-----|----------|
| WSCAD Universe 880-907/999-940 |  | URL | Download |
|--------------------------------|--|-----|----------|

## Environmental Product Compliance

### Compliance Search

|   |  |     |          |
|---|--|-----|----------|
| Environmental Product Compliance 880-907/999-940<br>2-conductor ground terminal block; 4 mm <sup>2</sup> ; side and center marking; for DIN-rail 35 x 15 and 35 x 7.5; CAGE CLAMP®; 4,00 mm <sup>2</sup> ; green-yellow |  | URL | Download |
|---|--|-----|----------|

Subject to changes. Please also observe the further product documentation!

## Installation Notes

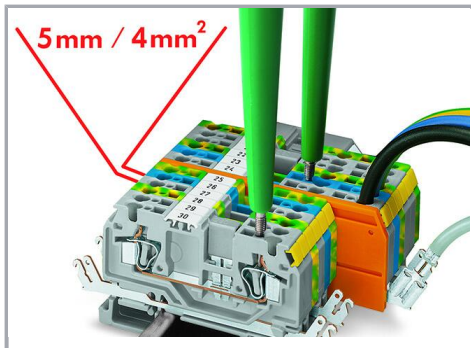

## Features

- 2-, 3- and 4-conductor terminal blocks, just 5 mm wide
- Conductor cross-sections up to 4 mm<sup>2</sup> (per VDE 0281) or 12 AWG with ferrule (Item No. 216-206) 2.5 mm<sup>2</sup> rubber-insulated conductors with outer diameter up to 4.4 mm
- Shield contact via 6.3 (2 x 2.8) mm solder/crimp quick disconnect terminal
- Test plug, red, 2 mm Ø
- WMB markers
- Mini-WSB markers, on both sides
- Commoning with WAGO jumper systems

## Testing

Subject to changes. Please also observe the further product documentation!

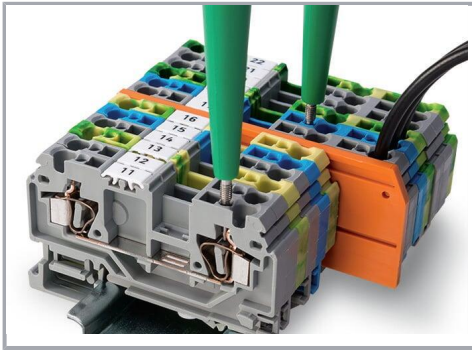

880 Series Terminal Blocks have an additional test slot for voltage tester.

## Product family

### Classic

EPSITRON® CLASSIC POWER: The Robust Power Supply – with Integrated TopBoost (Optional)

[Show all products from the family](#)

Subject to changes. Please also observe the further product documentation!