

# APE

Washable

RoHS Compliant

## Subminiature Pushbutton Switches

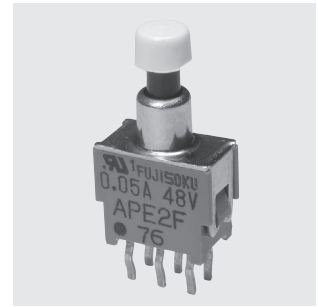

UL

### ■ Features

1. Twin-contact clip mechanism for high reliability.
2. Process sealed structure
3. Gold-plated contacts.
4. Terminal pin pitch: 2.54 mm.
5. UL recognized

### ■ Specifications

Rating	0.4VA AC, DC Max:50mA 60VAC/DC Min:1μA 20mVAC/DC UL:48VAC/DC 50mA
Initial contact resistance	50mΩ max. (1.5mA 200μVAC)
Dielectric strength	250VAC 1 minute
Initial Insulation resistance	500MΩ min. (500VDC)
Electrical life	10,000 operations at maximum rating. 30,000 operations at 0.4VA
Operating force	0.78~2.94N
Operating temperature range	-20~+85°C
Storage temperature range	-40~+85°C

### ■ Part Numbering

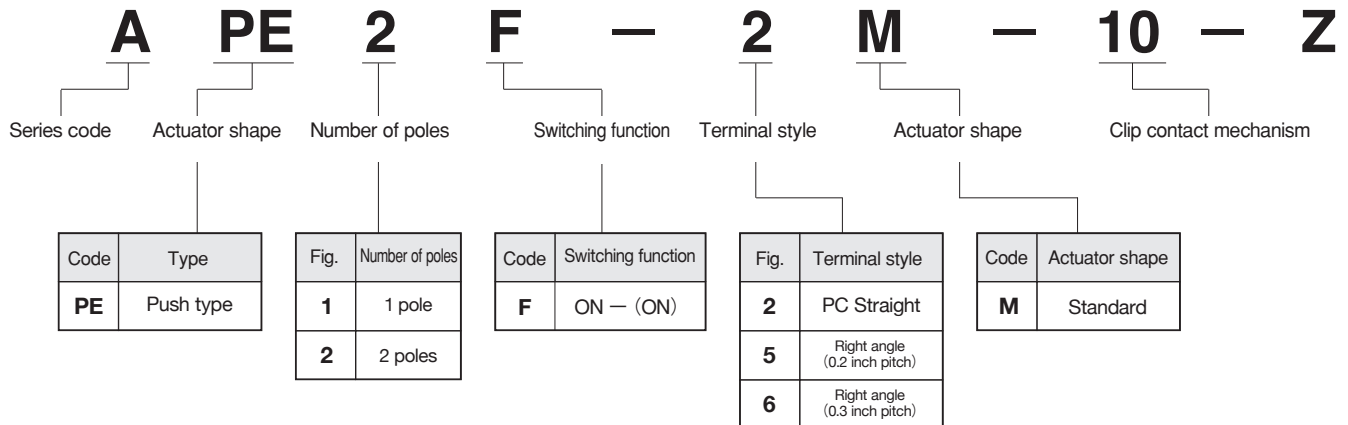

■ Optional Accessories..... Page 253.

# APE-M (Standard type)

## SPDT

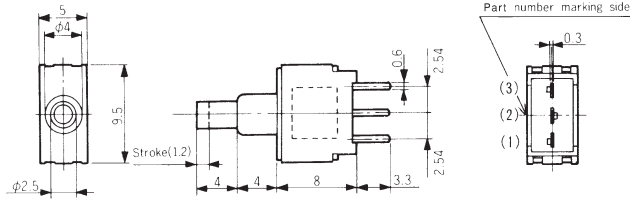

Switching function		Push 
Part No.	<b>APE1F-2M-10-Z</b>	(ON)
Connecting terminals	2-3	2-1

PC Straight

Terminal numbers are not shown on the switch.

## DPDT

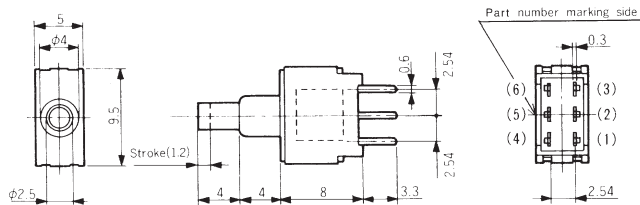

Switching function		Push 
Part No.	<b>APE2F-2M-10-Z</b>	(ON)
Connecting terminals	2-3 5-6	2-1 5-4

PC Straight

Terminal numbers are not shown on the switch.

## SPDT

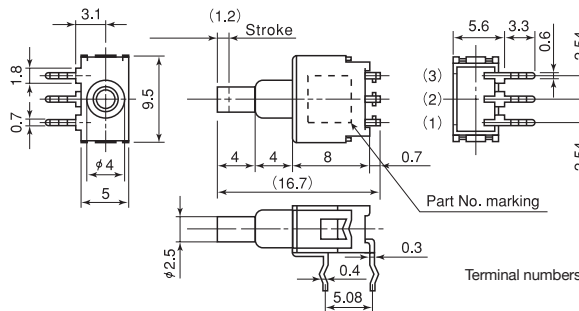
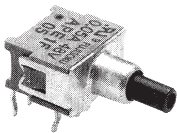

Switching function		Push 
Part No.	<b>★APE1F-5M-10-Z</b>	(ON)
Connecting terminals	2-3	2-1

0.2R/A

Terminal numbers are not shown on the switch.

## DPDT

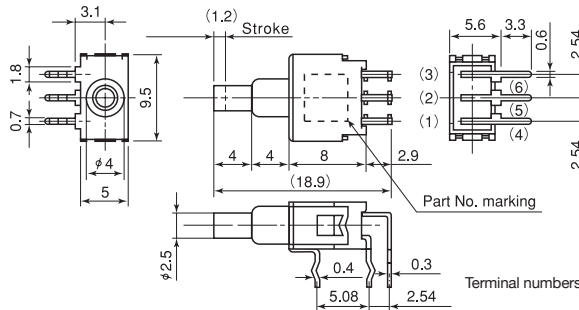
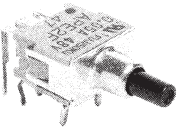

Switching function		Push 
Part No.	<b>★APE2F-5M-10-Z</b>	(ON)
Connecting terminals	2-3 5-6	2-1 5-4

0.2R/A

Terminal numbers are not shown on the switch.

## SPDT

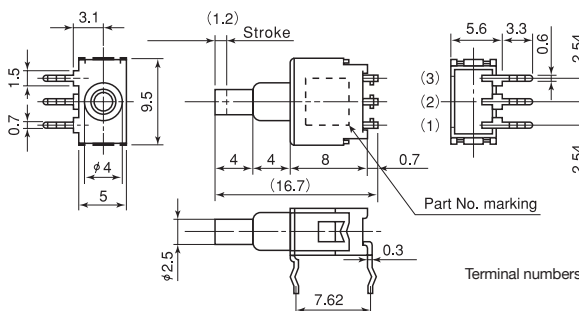
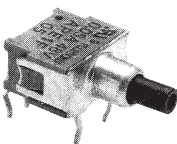

Switching function		Push 
Part No.	<b>APE1F-6M-10-Z</b>	(ON)
Connecting terminals	2-3	2-1

0.3R/A

Terminal numbers are not shown on the switch.

## DPDT

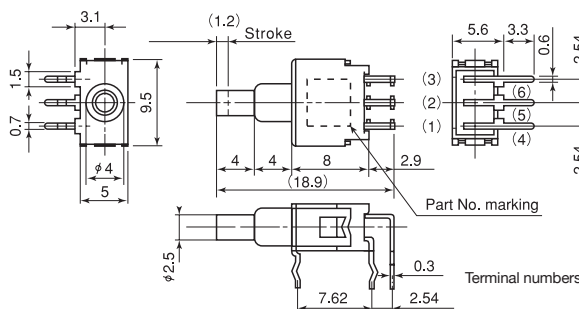
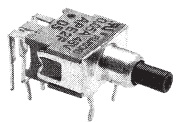

Switching function		Push 
Part No.	<b>☆APE2F-6M-10-Z</b>	(ON)
Connecting terminals	2-3 5-6	2-1 5-4

0.3R/A

Terminal numbers are not shown on the switch.

(ON) : Momentary.

☆ : Semi-standard products. ★ : Made to order products.

■ Right angle terminals

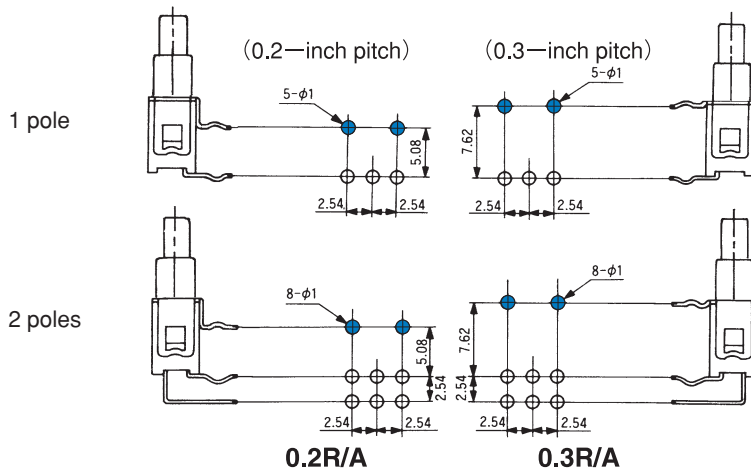

● The space between the terminal rows are available in two dimensions: 0.2 inches (5.08 mm) and 0.3 inches (7.62 mm).

[Example] 0.2-inch pitch : **APE1F-5M-10-Z**  
0.3-inch pitch : **APE1F-6M-10-Z**

■ Button Shape

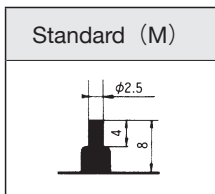

■ Bracket Installation Procedure

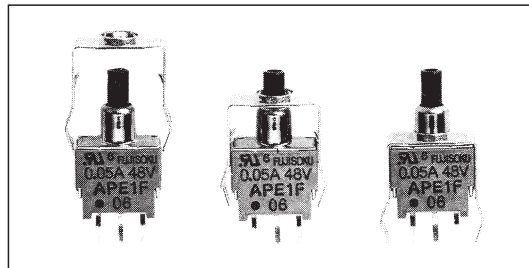

■ Mounting of Switch

- Use PC boards with hole diameter of 1mm.
- Do not bend the terminal pins before mounting the switch on the PC board.
- After mounting the switch, do not place the device in such a way that the device weight will be applied on to the actuator of the switch.
- Do not apply load exceeding 12.7 N to the actuator. If load exceeding 12.7 N is expected to be applied to the actuator, please use a **Bracket** (optional accessory sold separately). Maximum load will be 29.4 N when a **Bracket** is used.
- Use **Bracket 140000640314** or **140000640318** for side-by-side mounting.
- To increase mounting strength, use **Bracket 140000640315**.
- PC Hole Layouts will change depending on the **Bracket**. Please refer to P.245.

■ Color Cap Mounting

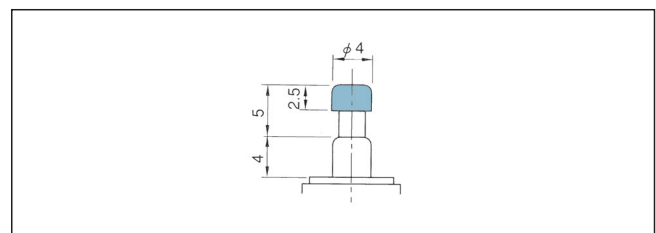

Refer to P.249.

■ Soldering Specifications

- (1) Manual Soldering
  - Device : Soldering iron
  - 380°C, Max.; 3 seconds, Max.
- (2) Auto Soldering
  - Device : Jet wave type or dip type
  - 275°C, Max.; 6 seconds, Max.
- Pre-heating should be done at temperatures ranging from 80° C to 120°C and within 120 seconds.

■ Flux Cleaning

- (1) Solvent : Fluorine or Alcohol type.
- (2) Cleaning after soldering should be done after the terminal temperature falls to 90°C or below, or after leaving the switch for five minutes or longer at room temperature.
- (3) Do not use ultrasonic cleaning.

■ PC Hole Layouts (AP · APE)

PC Straight

Mounting		Without Bracket	When optional Bracket is used.			
			140000640314 or 140000640316	140000640315 or 140000640317	140000640318	
Type	1 pole					
		2 poles				
			APE			

■ Right-angle Terminal

Terminal		0.2-inch pitch	0.3-inch pitch
		Type	Type
Type	1 pole		
	2 poles		

■ Packaging Specification

