

# TMC 83C 35A - Thermomagnetic device circuit breaker



1010303

<https://www.phoenixcontact.com/us/products/1010303>

Please be informed that the data shown in this PDF document is generated from our Online Catalog. Please find the complete data in the user documentation. Our General Terms of Use for Downloads are valid.

Thermomagnetic device circuit breaker, number of positions: 3, connection method: Screw, cross section: 1 mm<sup>2</sup>- 35 mm<sup>2</sup>, AWG: 18 - 2, mounting type: DIN rail, Color: gray



## Commercial Data

Item number	1010303
Packing unit	1 pc
Note	Made to Order (non-returnable)
Sales Key	CL08
Product Key	CLA125
GTIN	4055626484204
Weight per Piece (including packing)	222.222 g
Weight per Piece (excluding packing)	222.222 g
Customs tariff number	85362010
Country of origin	CN

# TMC 83C 35A - Thermomagnetic device circuit breaker



1010303

<https://www.phoenixcontact.com/us/products/1010303>

## Technical Data

### Product properties

Type	DIN rail module, one-piece
Product type	Thermomagnetic device circuit breakers
Product family	TMC 8
Number of positions	3
Mechanical service life	20000

### Electrical properties

Service life electrical	6000
-------------------------	------

#### General

Operating voltage	240 V AC (Delta)
Rated current $I_N$	35 A
Tripping method	TM (thermomagnetic)
Rated short-circuit switching capacity $I_{cn}$	10 kA (IC)
Fuse	C

### Connection data

Tightening torque	... 2 Nm
Conductor cross section rigid	1 mm <sup>2</sup> ... 35 mm <sup>2</sup>
Cross section AWG	18 ... 2 (converted acc. to IEC)
Conductor cross section flexible	1 mm <sup>2</sup> ... 35 mm <sup>2</sup>
Connection method	Screw
Tightening torque, min	2 Nm
Conductor cross section flexible max.	35 mm <sup>2</sup>
Conductor cross section, rigid max.	35 mm <sup>2</sup>

### Dimensions

Dimensional drawing	
Width	52.9 mm
Height	116 mm
Depth	65.7 mm

### Material specifications

Color	gray
-------	------

### Environmental and real-life conditions

#### Ambient conditions

# TMC 83C 35A - Thermomagnetic device circuit breaker



1010303

<https://www.phoenixcontact.com/us/products/1010303>

Ambient temperature (operation)	-35 °C ... 70 °C
Humidity test	48 h, 95% RH, 40°C (IEC 60068-2-78)
Shock (operation)	30g (11 ms) (IEC 60068-2-11)
Vibration (operation)	±0.38 mm (10-57 Hz), 5g (57...500 Hz) (IEC 60068-2-6, Fc, sine)

## Standards and regulations

Standards/specifications	UL 489
Standards/specifications	IEC 60947-2

## Mounting

Mounting type	DIN rail
---------------	----------

Drawings

Diagram

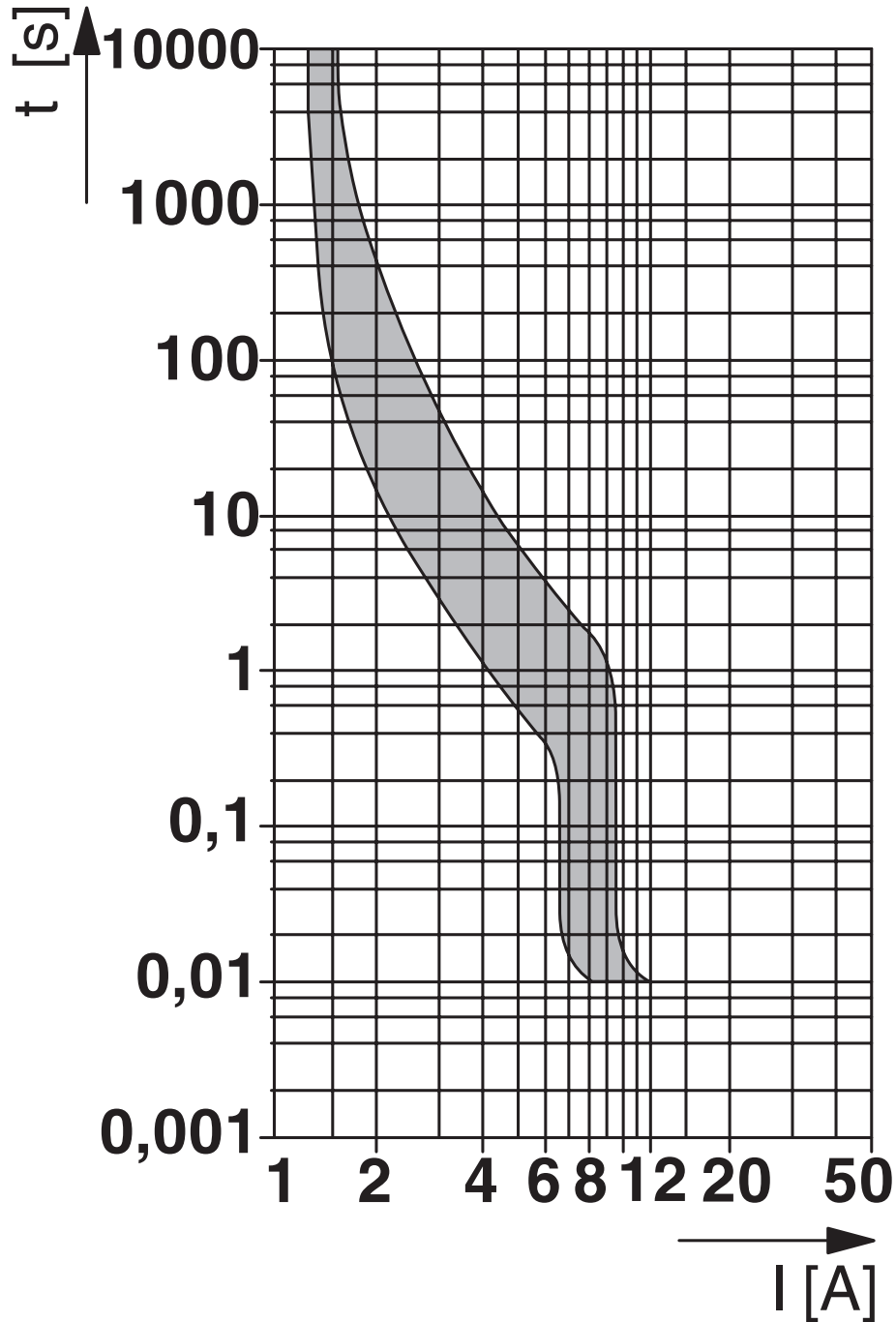

# TMC 83C 35A - Thermomagnetic device circuit breaker



1010303

<https://www.phoenixcontact.com/us/products/1010303>

Dimensional drawing

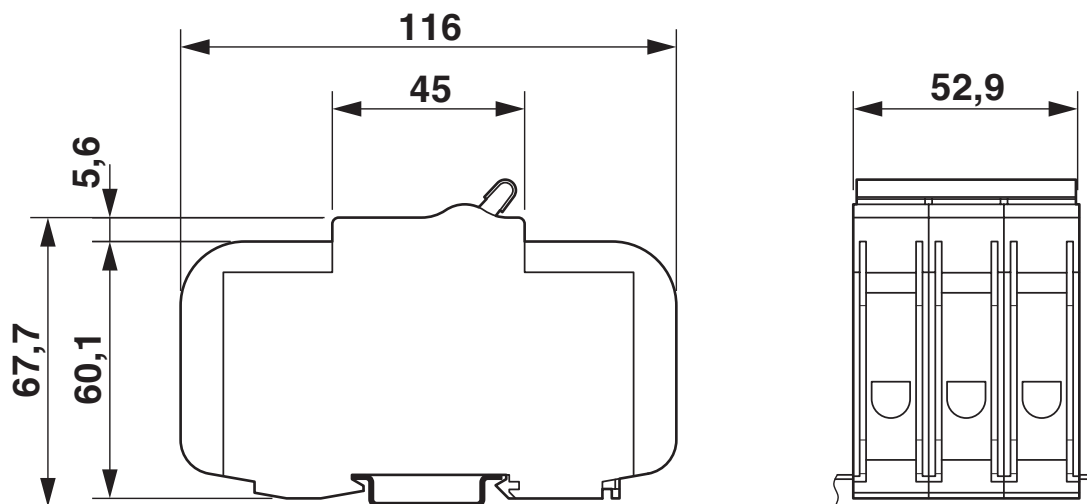

# TMC 83C 35A - Thermomagnetic device circuit breaker



1010303

<https://www.phoenixcontact.com/us/products/1010303>

## Approvals



**UL Listed**

Approval ID: FILE E 320373



**cUL Listed**

Approval ID: FILE E 320373



**TÜV Rheinland**

Approval ID: R 50531587

# TMC 83C 35A - Thermomagnetic device circuit breaker



1010303

<https://www.phoenixcontact.com/us/products/1010303>

## Classifications

### ECLASS

ECLASS-11.0	27141116
ECLASS-12.0	27141116
ECLASS-13.0	27250113

### ETIM

ETIM 7.0	EC000899
----------	----------

### UNSPSC

UNSPSC 21.0	39121410
-------------	----------

# TMC 83C 35A - Thermomagnetic device circuit breaker



1010303

<https://www.phoenixcontact.com/us/products/1010303>

## Environmental Product Compliance

REACH SVHC	Lead 7439-92-1
	Cadmium oxide 1306-19-0



# TMC 83C 35A - Thermomagnetic device circuit breaker



1010303

<https://www.phoenixcontact.com/us/products/1010303>

## Accessories

### TMC 8 B3 80 57 C - Wiring bridge

2907996

<https://www.phoenixcontact.com/us/products/2907996>



Bus bar for TMC 83... circuit breakers (three phase) 17.8 mm pitch, up to 57 positions. Rated for 80 A (end feed) 600 V AC/DC. UL 508 Listed for connection of UL 489 rated circuit breakers.

---

### TMC 8 B3 80 48 CA - Wiring bridge

2907997

<https://www.phoenixcontact.com/us/products/2907997>

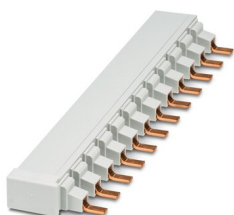

Bus bar for TMC 83... circuit breakers (three phase) with auxilliary switch. 17.8 mm pitch, up to 48 positions. Rated for 80 A (end feed) 600 V AC/DC. UL 508 Listed for connection of UL 489 rated circuit breakers.

# TMC 83C 35A - Thermomagnetic device circuit breaker



1010303

<https://www.phoenixcontact.com/us/products/1010303>

## TMC 8 B TERM PIN - Terminal adapter

2907998

<https://www.phoenixcontact.com/us/products/2907998>

Feeder terminal adapter for TMC 8..... circuit breaker bus bars. Rated for 1000 V AC/DC, 115 A. Wire range 14...2 AWG. UL Listed for connection to UL 489 rated circuit breakers.



---

## TMC 8 B END CAP - Wiring bridge end cover

2907999

<https://www.phoenixcontact.com/us/products/2907999>

Protective end covers for TMC 8 bus bars



# TMC 83C 35A - Thermomagnetic device circuit breaker



1010303

<https://www.phoenixcontact.com/us/products/1010303>

## TMC 8 B BUS CAP - Protective cover

2908000

<https://www.phoenixcontact.com/us/products/2908000>

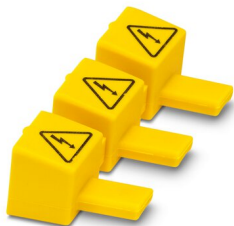

Protective covers for TMC 8 bus bars. Cuttable, three positions, yellow.

---

## TMC 7/8 AUX - Thermomagnetic device circuit breaker

2908219

<https://www.phoenixcontact.com/us/products/2908219>



Thermomagnetic device circuit breaker, number of positions: 1, connection method: Screw, cross section: 1 mm<sup>2</sup>- 35 mm<sup>2</sup>, AWG: 18 - 2, mounting type: Snaps on to side of circuit breaker, Color: gray

# TMC 83C 35A - Thermomagnetic device circuit breaker



1010303

<https://www.phoenixcontact.com/us/products/1010303>

## TMC 7/8 ALARM - Thermomagnetic device circuit breaker

2908220

<https://www.phoenixcontact.com/us/products/2908220>



Thermomagnetic device circuit breaker, number of positions: 1, connection method: Screw, cross section: 1 mm<sup>2</sup>- 35 mm<sup>2</sup>, AWG: 18 - 2, mounting type: Snaps on to side of circuit breaker, Color: gray

## TMC 7/8 12VDC SHNT - Thermomagnetic device circuit breaker

2908221

<https://www.phoenixcontact.com/us/products/2908221>



Thermomagnetic device circuit breaker, number of positions: 1, connection method: Screw, cross section: 1 mm<sup>2</sup>- 35 mm<sup>2</sup>, AWG: 18 - 2, mounting type: Snaps on to side of circuit breaker, Color: gray

# TMC 83C 35A - Thermomagnetic device circuit breaker



1010303

<https://www.phoenixcontact.com/us/products/1010303>

## TMC 7/8 24VDC SHNT - Thermomagnetic device circuit breaker

2908222

<https://www.phoenixcontact.com/us/products/2908222>



Thermomagnetic device circuit breaker, number of positions: 1, connection method: Screw, cross section: 1 mm<sup>2</sup>- 35 mm<sup>2</sup>, AWG: 18 - 2, mounting type: Snaps on to side of circuit breaker, Color: gray

## TMC 7/8 48VDC SHNT - Thermomagnetic device circuit breaker

2908224

<https://www.phoenixcontact.com/us/products/2908224>



Thermomagnetic device circuit breaker, number of positions: 1, connection method: Screw, cross section: 1 mm<sup>2</sup>- 35 mm<sup>2</sup>, AWG: 18 - 2, mounting type: Snaps on to side of circuit breaker, Color: gray

# TMC 83C 35A - Thermomagnetic device circuit breaker



1010303

<https://www.phoenixcontact.com/us/products/1010303>

## TMC 7/8 125VDC SHNT - Thermomagnetic device circuit breaker

2908225

<https://www.phoenixcontact.com/us/products/2908225>

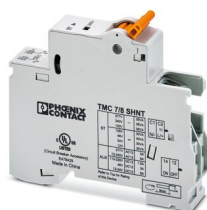

Thermomagnetic device circuit breaker, number of positions: 1, connection method: Screw, cross section: 1 mm<sup>2</sup>- 35 mm<sup>2</sup>, AWG: 18 - 2, mounting type: Snaps on to side of circuit breaker, Color: gray

## TMC 7/8 120VAC SHNT - Thermomagnetic device circuit breaker

2908226

<https://www.phoenixcontact.com/us/products/2908226>

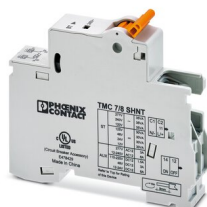

Thermomagnetic device circuit breaker, number of positions: 1, connection method: Screw, cross section: 1 mm<sup>2</sup>- 35 mm<sup>2</sup>, AWG: 18 - 2, mounting type: Snaps on to side of circuit breaker, Color: gray

# TMC 83C 35A - Thermomagnetic device circuit breaker



1010303

<https://www.phoenixcontact.com/us/products/1010303>

## TMC 7/8 240VAC SHNT - Thermomagnetic device circuit breaker

2908227

<https://www.phoenixcontact.com/us/products/2908227>



Thermomagnetic device circuit breaker, number of positions: 1, connection method: Screw, cross section: 1 mm<sup>2</sup>- 35 mm<sup>2</sup>, AWG: 18 - 2, mounting type: Snaps on to side of circuit breaker, Color: gray

## TMC 7/8 277VAC SHNT - Thermomagnetic device circuit breaker

2908228

<https://www.phoenixcontact.com/us/products/2908228>

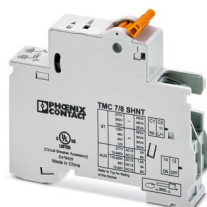

Thermomagnetic device circuit breaker, number of positions: 1, connection method: Screw, cross section: 1 mm<sup>2</sup>- 35 mm<sup>2</sup>, AWG: 18 - 2, mounting type: Snaps on to side of circuit breaker, Color: gray

# TMC 83C 35A - Thermomagnetic device circuit breaker



1010303

<https://www.phoenixcontact.com/us/products/1010303>

## EML (10X4)R - Label

0815583

<https://www.phoenixcontact.com/us/products/0815583>



Label, Roll, white, unlabeled, can be labeled with: THERMOMARK E.300 (D)/600 (D), THERMOMARK ROLL 2.0, THERMOMARK ROLL, THERMOMARK ROLL X1, THERMOMARK ROLLMASTER 300/600, THERMOMARK X1.2, mounting type: adhesive, lettering field size: 10 x 4 mm, Number of individual labels: 10000

## TML (104X3,8)R - Marker strip

0801833

<https://www.phoenixcontact.com/us/products/0801833>



Marker strip, Roll, white, unlabeled, can be labeled with: THERMOMARK E.300 (D)/600 (D), THERMOMARK ROLL 2.0, THERMOMARK ROLL, THERMOMARK ROLL X1, THERMOMARK ROLLMASTER 300/600, THERMOMARK X1.2, mounting type: adhesive, for terminal block width: 104 mm, lettering field size: 104 x 3.8 mm, Number of individual labels: 2500

Phoenix Contact 2023 © - all rights reserved  
<https://www.phoenixcontact.com>

Phoenix Contact USA  
586 Fulling Mill Road  
Middletown, PA 17057, United States  
(+717) 944-1300  
[info@phoenixcon.com](mailto:info@phoenixcon.com)