

REVISIONS					
REV	ECO	DESCRIPTION	DATE	BY	APPR
A3	-	RELEASE NEW DWG FORMAT	27DEC13	JARRY	

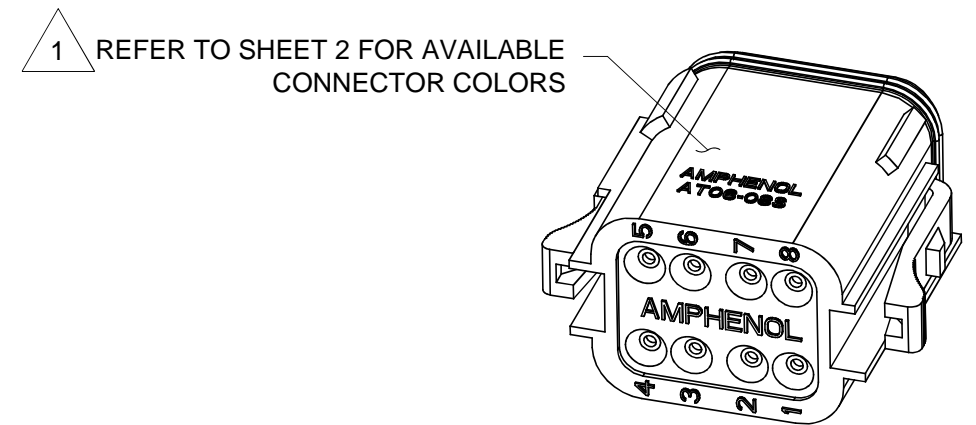
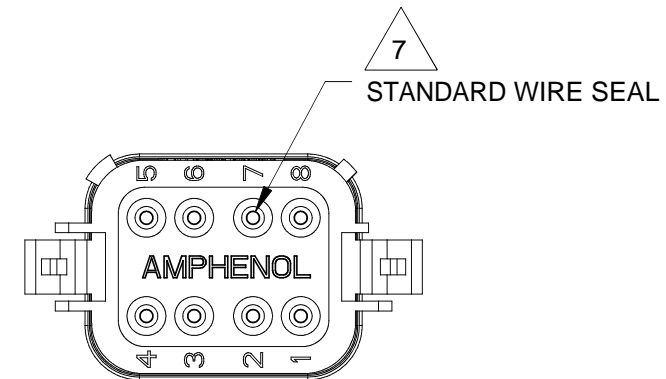
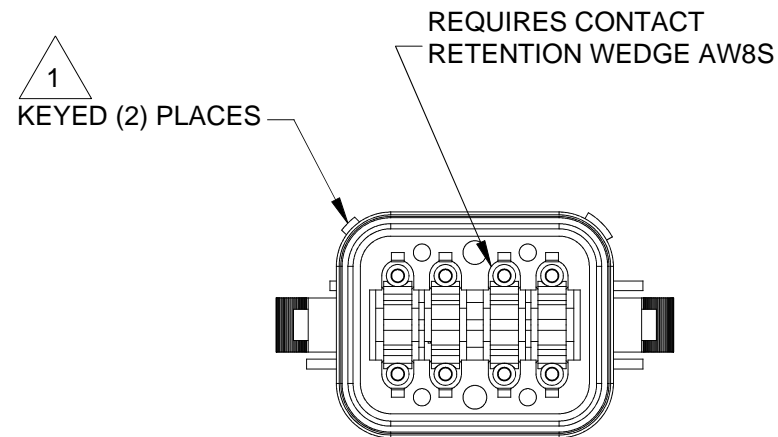
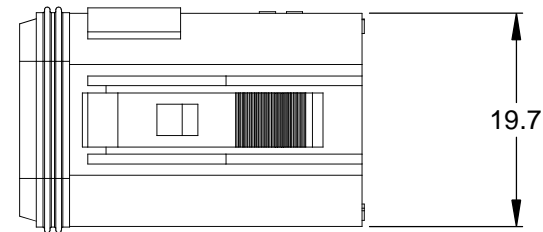
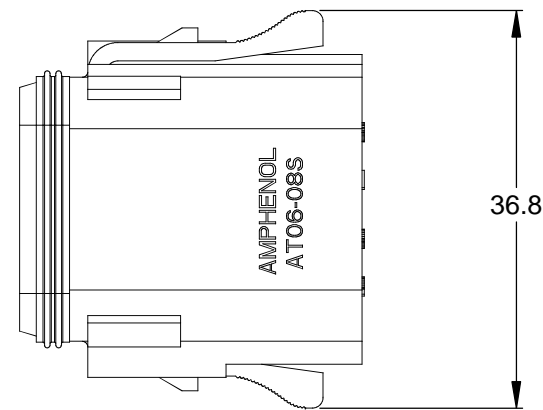

NOTES: UNLESS OTHERWISE SPECIFIED

1 SEE SHEET 2 FOR KEY ARRANGEMENTS AND COLORS.

2. MATERIAL:
HOUSING: THERMOPLASTIC
SEAL: SILICONE RUBBER

3. MODIFICATIONS: N/A

4. SPECIFICATIONS:
4.1 CURRENT RATING: 13 AMPS
4.2 OPERATING TEMPERATURE: -55°C TO +125°C
4.3 DIELECTRIC WITHSTANDING VOLTAGE: LESS THAN 2 MILLIAMPS CURRENT LEAKAGE @ 1500 VOLTS AC.
4.4 INSULATION RESISTANCE: 1000 MEGOHMS MIN @ 25°C.
4.5 MOISTURE RESISTANCE: IP67 (MATED CONDITION)
4.6 MATING CYCLE DURABILITY: 100 CYCLES
4.7 RoHS COMPLIANT

5. MATING PART: AT04-08PX* RECEPTACLE
(X = A,B,C,D KEYS; * = MODIFICATIONS AND COLORS)

6. ALL DIMENSIONS ARE FOR REFERENCE USE ONLY.

7 CONTACT SIZE AND REAR SEAL WIRE RANGE:

CONTACT SIZE	MIN. INSUL O.D.	MAX. INSUL O.D.	TYPICAL WIRE RANGE
16	2.24 mm (.088 in)	3.68 mm (.145 in)	14 - 20 AWG

QUANTITY	SEE SHEET 2 PART NUMBER	DESCRIPTION	ITEM										
MATERIALS LIST													
UNLESS OTHERWISE SPECIFIED 1) All dimensions are in metric(mm). 2) Tolerances are as follows: 1 PL DEC ±0.30 2 PL DEC ±0.15 3 PL DEC ±0.08 Fractions ±1/64 Angles ±1° 3) Note reference =		<table border="1"> <thead> <tr> <th>SIGNATURES</th> <th>DATE</th> </tr> </thead> <tbody> <tr> <td>DRAWN: JARRY</td> <td>27DEC13</td> </tr> <tr> <td>CHECKED:</td> <td></td> </tr> <tr> <td>ENGINEER:</td> <td></td> </tr> <tr> <td>APPROVAL:</td> <td></td> </tr> </tbody> </table>		SIGNATURES	DATE	DRAWN: JARRY	27DEC13	CHECKED:		ENGINEER:		APPROVAL:	
SIGNATURES	DATE												
DRAWN: JARRY	27DEC13												
CHECKED:													
ENGINEER:													
APPROVAL:													
MATERIAL SPECIFICATIONS:		<p style="text-align: center;">Amphenol</p> <p style="text-align: center;">Sine Systems - www.amphenol-sine.com 44724 Morley Drive Clinton Township, MI 48036</p>											
PROCESS SPECIFICATIONS:		<p style="text-align: center;">PLUG, 8 SOCKET, AT SERIES, KEYED</p>											
NEXT ASSY:		<table border="1"> <thead> <tr> <th>SIZE</th> <th>TYPE</th> <th>DWG NO.</th> <th>REVISION</th> </tr> </thead> <tbody> <tr> <td>B</td> <td>C-</td> <td>AT06-08SX-XXX</td> <td>A3</td> </tr> </tbody> </table>		SIZE	TYPE	DWG NO.	REVISION	B	C-	AT06-08SX-XXX	A3		
SIZE	TYPE	DWG NO.	REVISION										
B	C-	AT06-08SX-XXX	A3										
		<table border="1"> <thead> <tr> <th>SCALE</th> <th>SHEET</th> <th>OF</th> </tr> </thead> <tbody> <tr> <td>NONE</td> <td>1</td> <td>2</td> </tr> </tbody> </table>		SCALE	SHEET	OF	NONE	1	2				
SCALE	SHEET	OF											
NONE	1	2											

TITLE: PLUG, 8 SOCKET, AT SERIES, KEYED

DWG NO.: AT06-08SX-XXX

REV: A3

SH: 1

OF: 2

REVISIONS					
REV	ECO	DESCRIPTION	DATE	BY	APPR

P/N AT06-08SA
KEY-A CONFIGURATION
STANDARD COLOR: GREY

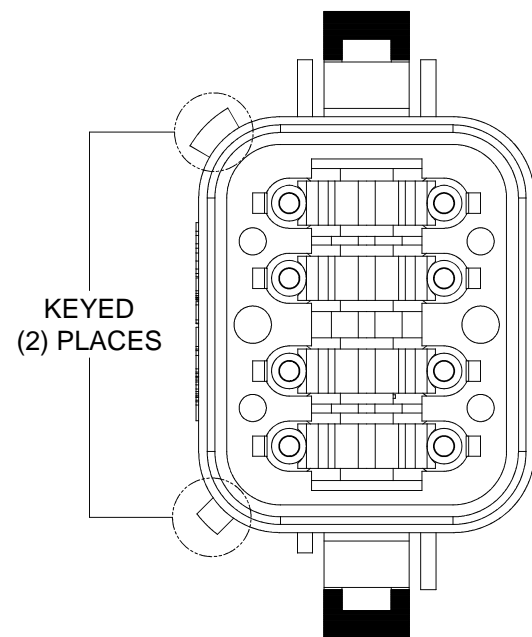

KEY-A CONFIGURATION	
COLOR	PART NUMBER
* GREY	AT06-08SA
BLACK	AT06-08SA-BLK
GREEN	AT06-08SA-GRN
BROWN	AT06-08SA-BRN

P/N AT06-08SB
KEY-B CONFIGURATION
STANDARD COLOR: BLACK

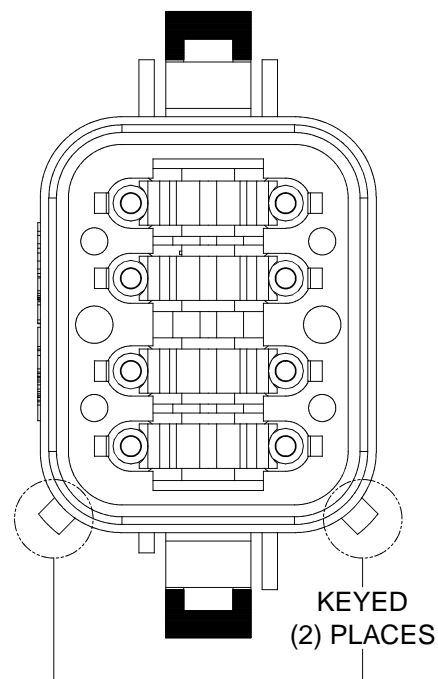

KEY-B CONFIGURATION	
COLOR	PART NUMBER
GREY	AT06-08SB-GRY
* BLACK	AT06-08SB
GREEN	AT06-08SB-GRN
BROWN	AT06-08SB-BRN

P/N AT06-08SC
KEY-C CONFIGURATION
STANDARD COLOR: GREEN

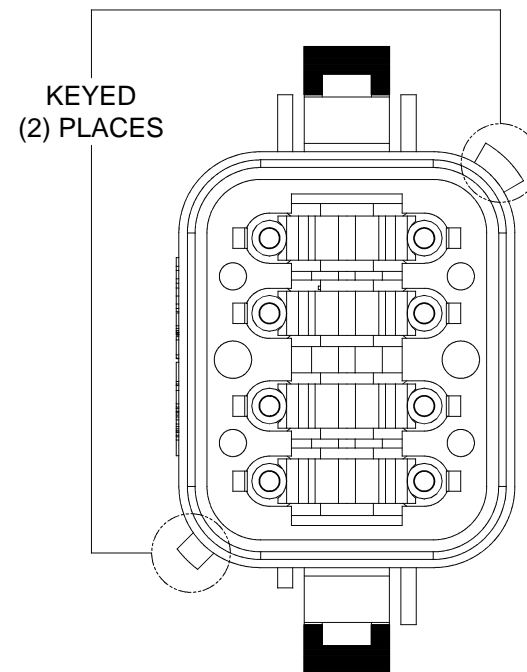

KEY-C CONFIGURATION	
COLOR	PART NUMBER
GREY	AT06-08SC-GRY
BLACK	AT06-08SC-BLK
* GREEN	AT06-08SC
BROWN	AT06-08SC-BRN

P/N AT06-08SD
KEY-D CONFIGURATION
STANDARD COLOR: BROWN

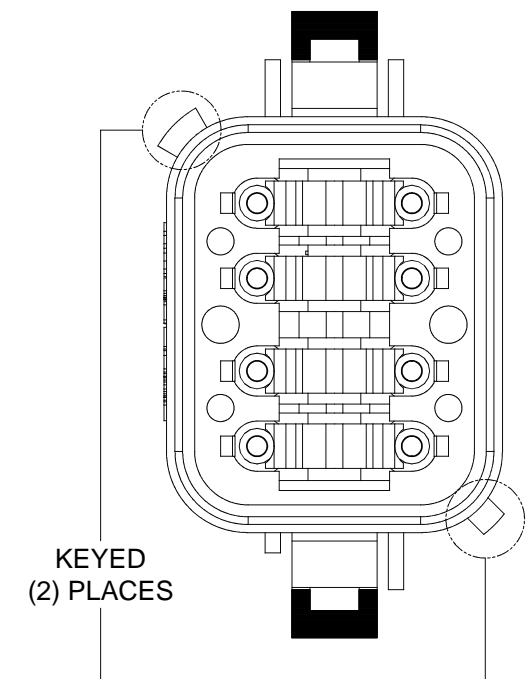

KEY-D CONFIGURATION	
COLOR	PART NUMBER
GREY	AT06-08SD-GRY
BLACK	AT06-08SD-BLK
GREEN	AT06-08SD-GRN
* BROWN	AT06-08SD

NOTE:

AN ASTERISKS (*) PLACED BEFORE THE COLOR DENOTES THE STANDARD MOLDED COLOR OF THE CONNECTORS SHOWN ABOVE.

OTHER COLORS SHOWN ARE AVAILABLE VIA SPECIAL ORDER.

TITLE: PLUG, 8 SOCKET, AT SERIES, KEDED
DWG NO: AT06-08SX-XXX
REV: A3
SH: 2
OF: 2

QUANTITY	PART NUMBER	DESCRIPTION	ITEM												
MATERIALS LIST															
UNLESS OTHERWISE SPECIFIED 1) All dimensions are in metric(mm). 2) Tolerances are as follows: 1 PL DEC ±0.30 2 PL DEC ±0.15 3 PL DEC ±0.08 Fractions ±1/64 Angles ±1° 3) Note reference =		<table border="1"> <tr> <th>SIGNATURES</th> <th>DATE</th> </tr> <tr> <td>DRAWN: JARRY</td> <td>27DEC13</td> </tr> <tr> <td>CHECKED:</td> <td></td> </tr> <tr> <td>ENGINEER:</td> <td></td> </tr> <tr> <td>APPROVAL:</td> <td></td> </tr> <tr> <td colspan="2">CUSTOMER:</td> </tr> </table>		SIGNATURES	DATE	DRAWN: JARRY	27DEC13	CHECKED:		ENGINEER:		APPROVAL:		CUSTOMER:	
SIGNATURES	DATE														
DRAWN: JARRY	27DEC13														
CHECKED:															
ENGINEER:															
APPROVAL:															
CUSTOMER:															
MATERIAL SPECIFICATIONS:		<h1>Amphenol</h1> <p>Sine Systems - www.amphenol-sine.com 44724 Morley Drive Clinton Township, MI 48036</p> <p>PLUG, 8 SOCKET, AT SERIES, KEYED</p>													
PROCESS SPECIFICATIONS:															
NEXT ASSY:		<table border="1"> <tr> <td>SIZE</td> <td>TYPE</td> <td>DWG NO:</td> <td>REVISION</td> </tr> <tr> <td>B</td> <td>C-</td> <td>AT06-08SX-XXX</td> <td>A3</td> </tr> </table>	SIZE	TYPE	DWG NO:	REVISION	B	C-	AT06-08SX-XXX	A3					
SIZE	TYPE	DWG NO:	REVISION												
B	C-	AT06-08SX-XXX	A3												
		SCALE: NONE	SHEET 2 OF 2												

AT Series™ - Contact Size 16 Options

Machined Contacts, Sockets & Pins				
Part Number	Description	Size	AWG	Type
AT60-215-1631	Male Contact - Pin, Gold-plated	16	14	Machined
AT62-209-1631	Female Contact - Socket, Gold-plated	16	14	Machined
AT60-215-16141	Male Contact - Pin, Nickel-plated	16	14	Machined
AT62-209-16141	Female Contact - Socket, Nickel-plated	16	14	Machined
AT60-202-1631	Male Contact - Pin, Gold-plated	16	16-20	Machined
AT62-201-1631	Female Contact - Socket, Gold-plated	16	16-20	Machined
AT60-202-16141	Male Contact - Pin, Nickel-plated	16	16-20	Machined
AT62-201-16141	Female Contact - Socket, Nickel-plated	16	16-20	Machined
AT60-202-1631-22	Male Contact - Pin, Gold-plated	16	22-24	Machined
AT62-201-1631-22	Female Contact - Socket, Gold-plated	16	22-24	Machined
AT60-202-16141-22	Male Contact - Pin, Nickel-plated	16	22-24	Machined
AT62-201-16141-22	Female Contact - Socket, Nickel-plated	16	22-24	Machined

Tooling - Machined Contacts		
Part	Part Number	Description
	CA-5D12	Universal Hand Crimp Tool, Size 12/16/20 (Machined contacts only)
	CA-5E12	Pneumatic Crimp Tool, Size 12/16/20 (Machined contacts only)

Contact Removal Tools		
Part	Part Number	Description
	ART-100	Used for removal of contacts for A Series™ products
	AT11-310-1605	Contact Removal Tool, Plastic, Size 16

Sealing Plugs		
Part	Part Number	Description
	A114017	Sealing Plug, Size 16, White
	A114017-SR	Sealing Plug, Size 16, SR01 Series, Black
	AT13-217-1605	Locking Sealing Plug, Size 16, Grey
	AT13-217-1605-SR	Locking Sealing Plug, Size 16, SR01 Series, Red

Stamped & Formed Contacts, Sockets & Pins				
Part Number	Description	Size	AWG	Type
AT60-14-0144	Male Contact - Pin, Gold-plated	16	14-16	Stamped & Formed
AT62-14-0144	Female Contact - Socket, Gold-plated	16	14-16	Stamped & Formed
AT60-14-0122	Male Contact - Pin, Nickel-plated	16	14-16	Stamped & Formed
AT62-14-0122	Female Contact - Socket, Nickel-plated	16	14-16	Stamped & Formed
AT60-16-0144	Male Contact - Pin, Gold-plated	16	16-18	Stamped & Formed
AT62-16-0144	Female Contact - Socket, Gold-plated	16	16-18	Stamped & Formed
AT60-16-0122	Male Contact - Pin, Nickel-plated	16	16-18	Stamped & Formed
AT62-16-0122	Female Contact - Socket, Nickel-plated	16	16-18	Stamped & Formed
AT60-16-0644	Male Contact - Pin, Gold-plated	16	18-20	Stamped & Formed
AT62-16-0644	Female Contact - Socket, Gold-plated	16	18-20	Stamped & Formed
AT60-16-0622	Male Contact - Pin, Nickel-plated	16	18-20	Stamped & Formed
AT62-16-0622	Female Contact - Socket, Nickel-plated	16	18-20	Stamped & Formed
AT60-16-0844	Male Contact - Pin, Gold-plated	16	20-22	Stamped & Formed
AT62-16-0844	Female Contact - Socket, Gold-plated	16	20-22	Stamped & Formed
AT60-16-0822	Male Contact - Pin, Nickel-plated	16	20-22	Stamped & Formed
AT62-16-0822	Female Contact - Socket, Nickel-plated	16	20-22	Stamped & Formed

Tooling - Stamped & Formed Contacts		
Part	Part Number	Description
	MF-3950	Crimp Die - Size 16, 18-20AWG (S&F contacts only)
	MF-3953	Crimp Die - Size 16, 16-18AWG (S&F contacts only)
	MF-3975	Crimp Die - Size 16, 14-16AWG (S&F contacts only)
	MF-3990	Crimp Die - Size 16, 20-22AWG (S&F contacts only)
	ATT-16-00	Hand Crimp Tool - Size 16, 14-16AWG (S&F contacts only)
	ATT-16-01	Hand Crimp Tool - Size 16, 18-20AWG (S&F contacts only)
	ATT-1612-03	Hand Crimp Tool - Size 16, 20-22AWG (S&F contacts only)

Amphenol Sine Systems
 44724 Morley Drive
 Clinton Township, MI 48036 USA
www.amphenol-sine.com
 03/2022