

## TUIJA-3-W

~55° wide beam

### TECHNICAL SPECIFICATIONS:

Dimensions	Ø 50.0 mm
Height	14.5 mm
Fastening	glue, pin
ROHS compliant	yes ⓘ

### MATERIAL SPECIFICATIONS:

Component	Type	Material	Colour	Finish
TUIJA-3-W	Multi-lens	PMMA	clear	

### ORDERING INFORMATION:

Component	Qty in box	MOQ	MPQ	Box weight (kg)
C11191_TUIJA-3-W » Box size: 480 x 280 x 300 mm	364	112	28	6.4



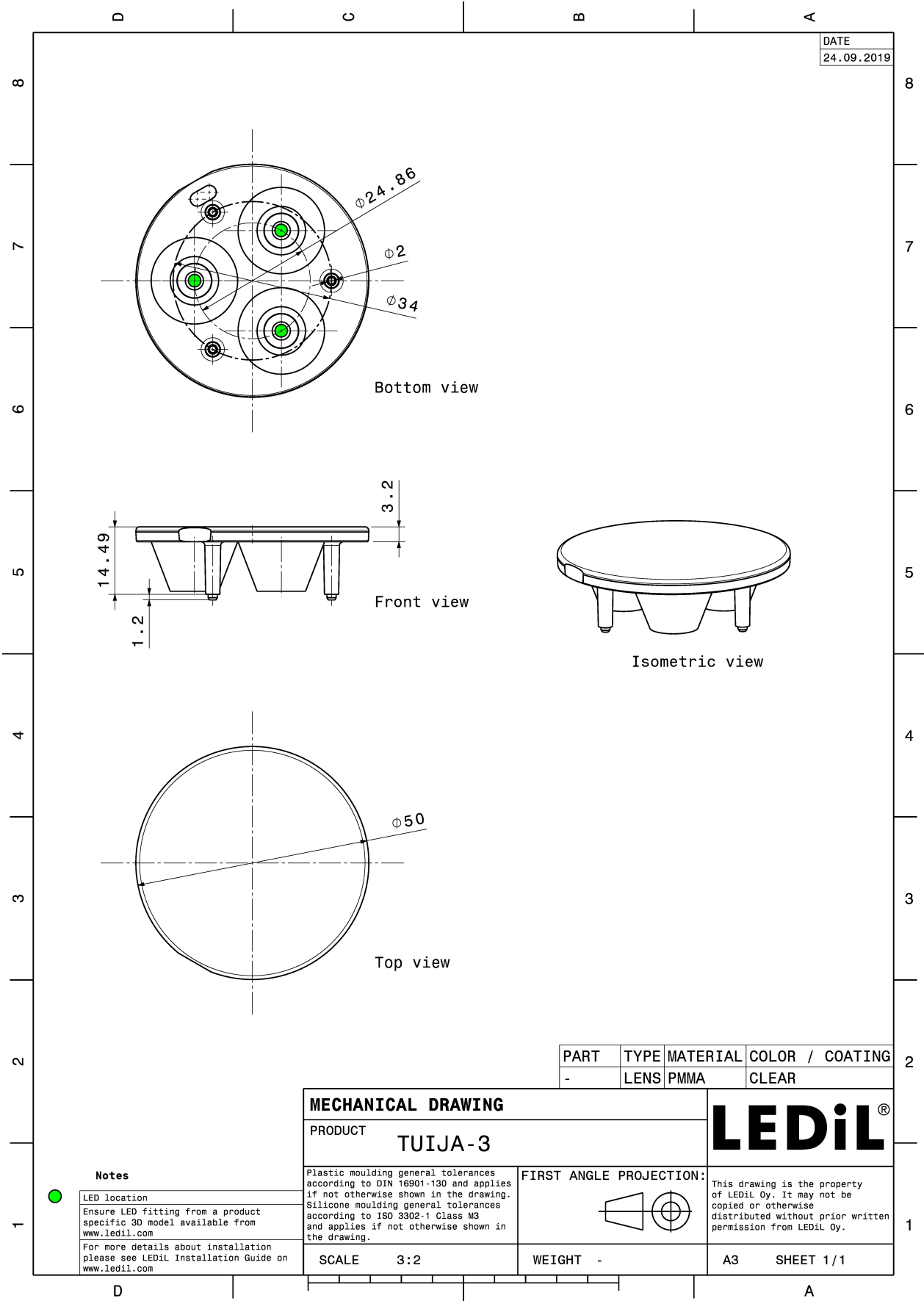

See also our general installation guide: [www.ledil.com/installation\\_guide](http://www.ledil.com/installation_guide)

### PHOTOMETRIC DATA (MEASURED):

#### CREE

LED XB-D  
 FWHM / FWTM 50.0° / 73.0°  
 Efficiency 92 %  
 Peak intensity 1.2 cd/lm  
 LEDs/each optic 1  
 Light colour White  
 Required components:

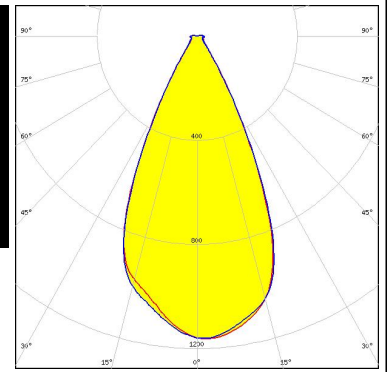

#### CREE

LED XB-D  
 FWHM / FWTM 49.0°  
 Efficiency 86 %  
 Peak intensity 1.1 cd/lm  
 LEDs/each optic 1  
 Light colour White  
 Required components:

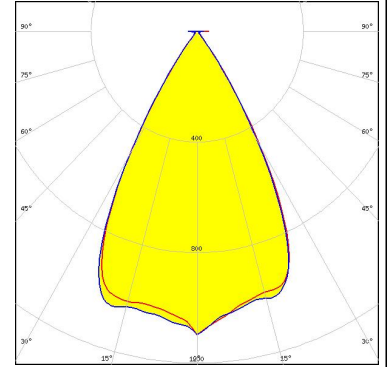

#### CREE

LED XP-E  
 FWHM / FWTM 58.0° / 74.0°  
 Efficiency 86 %  
 Peak intensity 0.9 cd/lm  
 LEDs/each optic 1  
 Light colour White  
 Required components:

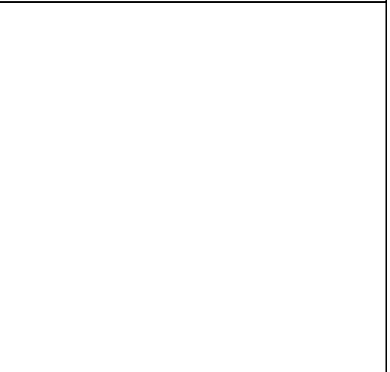

#### CREE

LED XP-G  
 FWHM / FWTM 59.0° / 76.0°  
 Efficiency 86 %  
 Peak intensity 0.8 cd/lm  
 LEDs/each optic 1  
 Light colour White  
 Required components:

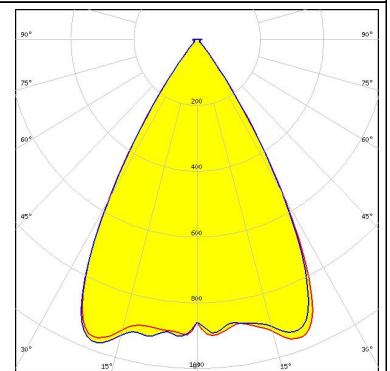

### PHOTOMETRIC DATA (MEASURED):

#### LUMILEDS

LED LUXEON A  
FWHM / FWTM 56.0°  
Efficiency 86 %  
LEDs/each optic 1  
Light colour White  
Required components:

#### LUMILEDS

LED LUXEON Rebel  
FWHM / FWTM 48.0° / 72.0°  
Efficiency 86 %  
Peak intensity 1.1 cd/lm  
LEDs/each optic 1  
Light colour White  
Required components:

#### LUMILEDS

LED LUXEON Rebel ES  
FWHM / FWTM 56.0° / 78.0°  
Efficiency 86 %  
Peak intensity 0.9 cd/lm  
LEDs/each optic 1  
Light colour White  
Required components:

#### OSRAM Opto Semiconductors

LED OSLOM SSL 80  
FWHM / FWTM 46.0° / 64.0°  
Efficiency 86 %  
Peak intensity 0.4 cd/lm  
LEDs/each optic 1  
Light colour White  
Required components:

### PHOTOMETRIC DATA (MEASURED):

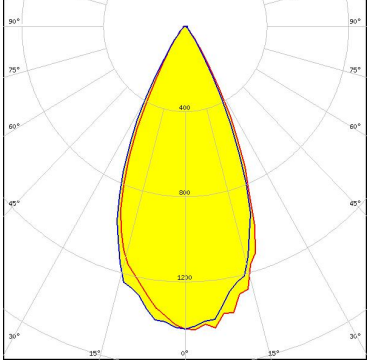
		
LED	Z5	
FWHM / FWTM	48.0° / 70.0°	
Efficiency	88 %	
Peak intensity	1.4 cd/lm	
LEDs/each optic	1	
Light colour	White	
Required components:		
<b>SHARP</b>		
LED	Double Dome (GM2BB)	
FWHM / FWTM	58.0°	
Efficiency	86 %	
LEDs/each optic	1	
Light colour	White	
Required components:		

#### PHOTOMETRIC DATA (SIMULATED):



LED XT-E  
 FWHM / FWTM 56.0° / 71.0°  
 Efficiency 93 %  
 Peak intensity 1.2 cd/lm  
 LEDs/each optic 1  
 Light colour White  
 Required components:

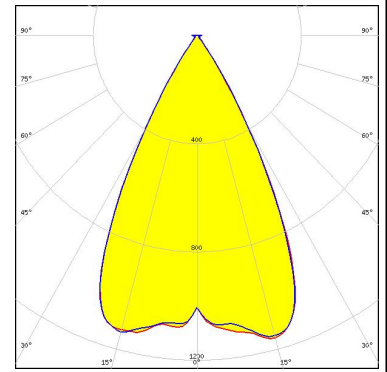

LED NCSxx19A  
 FWHM / FWTM 54.0°  
 Efficiency %  
 LEDs/each optic 1  
 Light colour White  
 Required components:



LED NVSxx19A  
 FWHM / FWTM 54.0°  
 Efficiency %  
 LEDs/each optic 1  
 Light colour White  
 Required components:



OSRAM  
Opto Semiconductors  
 LED OSOLON SSL 150  
 FWHM / FWTM 58.0°  
 Efficiency %  
 Peak intensity 1.1 cd/lm  
 LEDs/each optic 1  
 Light colour White  
 Required components:

#### PHOTOMETRIC DATA (SIMULATED):

#### OSRAM

Opto Semiconductors

LED SFH 4715AS  
 FWHM / FWTM 48.0° / 74.0°  
 Efficiency 94 %  
 Peak intensity 1.4 cd/lm  
 LEDs/each optic 1  
 Light colour IR  
 Required components:

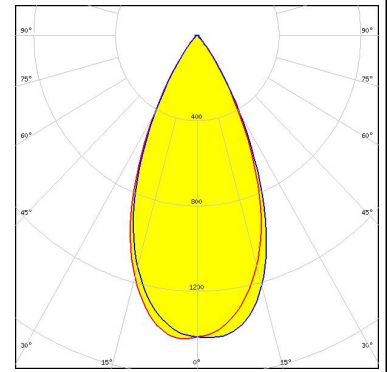

#### OSRAM

Opto Semiconductors

LED SFH 4716AS  
 FWHM / FWTM 56.0° / 81.0°  
 Efficiency 94 %  
 Peak intensity 1.1 cd/lm  
 LEDs/each optic 1  
 Light colour IR  
 Required components:

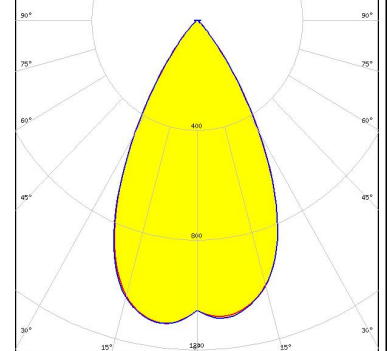

#### OSRAM

Opto Semiconductors

LED SFH 4725S  
 FWHM / FWTM 51.0° / 74.0°  
 Efficiency 94 %  
 Peak intensity 1.4 cd/lm  
 LEDs/each optic 1  
 Light colour IR  
 Required components:

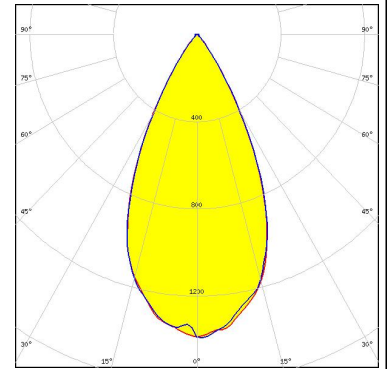

#### SAMSUNG

LED LH351C  
 FWHM / FWTM 65.0° / 88.0°  
 Efficiency 93 %  
 Peak intensity 0.9 cd/lm  
 LEDs/each optic 1  
 Light colour White  
 Required components:

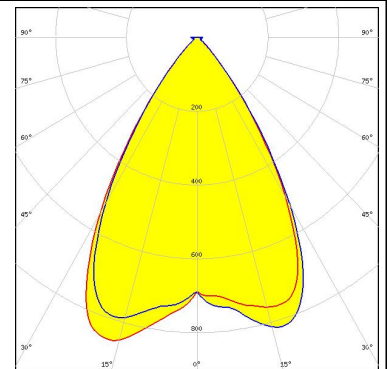

### GENERAL INFORMATION:

NOTE: The typical beam angle will be changed by different color, chip size and chip position tolerance. The typical total beam angle is the full angle measured where the luminous intensity is half of the peak value.

### MATERIALS:

As part of our continuous research and improvement processes, and to ensure the best possible quality and availability of our products, LEDiL reserves the right to change material grades without notice.

### PRODUCT DATA USER AGREEMENT AND DISCLAIMER:

The measured data in the provided downloadable LEDiL Product Datasheets and Mechanical 2D-Drawings is rounded and provided as reference for planning. LEDiL Oy's optical specifications have been verified by conducting performance testing of the products in accordance with the company's quality system. The reported data are averaged results of multiple measurements with typical variation. LEDiL Oy reserves the right to without prior notification make changes and improvements to its products.

LEDiL Oy assumes neither warranty, nor guarantee nor any other liability of any kind for the contents and correctness of the provided data. The provided data has been generated with highest diligence but the provided data may in reality not represent the complete possible variation range of all intrinsic parameters. Therefore, in certain cases a deviation from the provided data could occur.

LEDiL Oy reserves the right to undertake technical changes of its products without further notification which could lead to changes in the provided data. LEDiL Oy assumes no liability of any kind for the possible deviation from any provided data or any other damage resulting from the usage of the provided data.

The user agrees to this disclaimer and user agreement with the download or usage of the provided files.

#### LEDiL Oy

Joensuunkatu 13  
FI-24240 SALO  
Finland

#### LEDiL Inc.

228 West Page Street  
Suite D  
Sycamore IL 60178  
USA

#### Ledil Optics Technology (Shenzhen) Co., Ltd.

# 405 , Block B  
Casic Motor Building  
Shenzhen 518057  
P.R.CHINA

#### Local sales and technical support

[www.ledil.com/  
where\\_to\\_buy](http://www.ledil.com/where_to_buy)

#### Shipping locations

Salo, Finland  
Hong Kong, China

#### Distribution Partners

[www.ledil.com/  
where\\_to\\_buy](http://www.ledil.com/where_to_buy)