

2N6284 (NPN); 2N6286, 2N6287 (PNP)

Preferred Device

Darlington Complementary Silicon Power Transistors

These packages are designed for general-purpose amplifier and low-frequency switching applications.

Features

- High DC Current Gain @ $I_C = 10 \text{ Adc}$ –
 $h_{FE} = 2400 \text{ (Typ)} - 2N6284$
 $= 4000 \text{ (Typ)} - 2N6287$
- Collector–Emitter Sustaining Voltage –
 $V_{CEO(sus)} = 100 \text{ Vdc (Min)}$
- Monolithic Construction with Built–In Base–Emitter Shunt Resistors
- Pb–Free Packages are Available*

MAXIMUM RATINGS (Note 1)

Rating	Symbol	Value	Unit
Collector–Emitter Voltage 2N6286 2N6284/87	V_{CEO}	80 100	Vdc
Collector–Base Voltage 2N6286 2N6284/87	V_{CB}	80 100	Vdc
Emitter–Base Voltage	V_{EB}	5.0	Vdc
Collector Current – Continuous Peak	I_C	20 40	Adc
Base Current	I_B	0.5	Adc
Total Power Dissipation @ $T_C = 25^\circ\text{C}$ Derate above 25°C	P_D	160 0.915	W W/ $^\circ\text{C}$
Operating and Storage Temperature Range	T_J, T_{stg}	–65 to +200	$^\circ\text{C}$

THERMAL CHARACTERISTICS (Note 1)

Characteristic	Symbol	Max	Unit
Thermal Resistance, Junction–to–Case	$R_{\theta JC}$	1.09	$^\circ\text{C/W}$

Stresses exceeding Maximum Ratings may damage the device. Maximum Ratings are stress ratings only. Functional operation above the Recommended Operating Conditions is not implied. Extended exposure to stresses above the Recommended Operating Conditions may affect device reliability.

1. Indicates JEDEC Registered Data.

*For additional information on our Pb–Free strategy and soldering details, please download the ON Semiconductor Soldering and Mounting Techniques Reference Manual, SOLDERRM/D.



ON Semiconductor®

<http://onsemi.com>

20 AMPERE COMPLEMENTARY SILICON POWER TRANSISTORS 100 VOLTS, 160 WATTS



TO–204AA (TO–3)
CASE 1–07
STYLE 1

MARKING DIAGRAM



2N628x = Device Code
 $x = 4, 6 \text{ or } 7$
 G = Pb–Free Package
 A = Location Code
 YY = Year
 WW = Work Week
 MEX = Country of Origin

ORDERING INFORMATION

Device	Package	Shipping
2N6284	TO–3	100 Units/Tray
2N6284G	TO–3 (Pb–Free)	100 Units/Tray
2N6286	TO–3	100 Units/Tray
2N6286G	TO–3 (Pb–Free)	100 Units/Tray
2N6287	TO–3	100 Units/Tray
2N6287G	TO–3 (Pb–Free)	100 Units/Tray

2N6284 (NPN); 2N6286, 2N6287 (PNP)

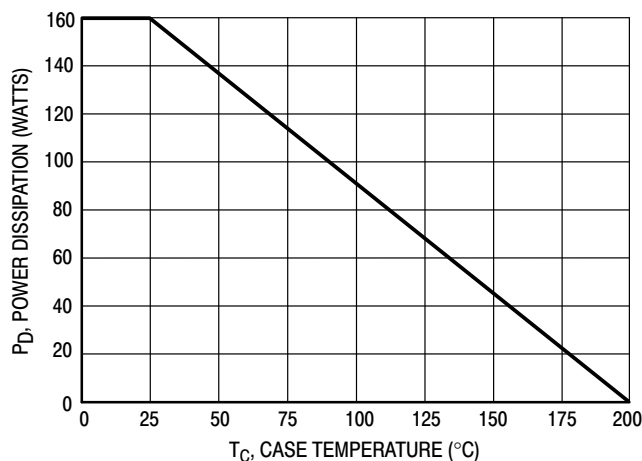

Figure 1. Power Derating

ELECTRICAL CHARACTERISTICS ($T_C = 25^\circ\text{C}$ unless otherwise noted) (Note 2)

Characteristic	Symbol	Min	Max	Unit
OFF CHARACTERISTICS				
Collector–Emitter Sustaining Voltage ($I_C = 0.1 \text{ Adc}$, $I_B = 0$)	$V_{CEO(sus)}$	80	–	Vdc
		100	–	
				2N6286 2N6284, 2N6287
Collector Cutoff Current ($V_{CE} = 40 \text{ Vdc}$, $I_B = 0$) ($V_{CE} = 50 \text{ Vdc}$, $I_B = 0$)	I_{CEO}	–	1.0	mAdc
		–	1.0	
Collector Cutoff Current ($V_{CE} = \text{Rated } V_{CB}$, $V_{BE(off)} = 1.5 \text{ Vdc}$) ($V_{CE} = \text{Rated } V_{CB}$, $V_{BE(off)} = 1.5 \text{ Vdc}$, $T_C = 150^\circ\text{C}$)	I_{CEX}	–	0.5	mAdc
		–	5.0	
Emitter Cutoff Current ($V_{BE} = 5.0 \text{ Vdc}$, $I_C = 0$)	I_{EBO}	–	2.0	mAdc

ON CHARACTERISTICS (Note 3)

DC Current Gain ($I_C = 10 \text{ Adc}$, $V_{CE} = 3.0 \text{ Vdc}$) ($I_C = 20 \text{ Adc}$, $V_{CE} = 3.0 \text{ Vdc}$)	h_{FE}	750	18,000	–
		100	–	
Collector–Emitter Saturation Voltage ($I_C = 10 \text{ Adc}$, $I_B = 40 \text{ mAdc}$) ($I_C = 20 \text{ Adc}$, $I_B = 200 \text{ mAdc}$)	$V_{CE(sat)}$	–	2.0	Vdc
		–	3.0	
Base–Emitter On Voltage ($I_C = 10 \text{ Adc}$, $V_{CE} = 3.0 \text{ Vdc}$)	$V_{BE(on)}$	–	2.8	Vdc
Base–Emitter Saturation Voltage ($I_C = 20 \text{ Adc}$, $I_B = 200 \text{ mAdc}$)	$V_{BE(sat)}$	–	4.0	Vdc

DYNAMIC CHARACTERISTICS

Magnitude of Common Emitter Small–Signal Short–Circuit Forward Current Transfer Ratio ($I_C = 10 \text{ Adc}$, $V_{CE} = 3.0 \text{ Vdc}$, $f = 1.0 \text{ MHz}$)	$ h_{fe} $	4.0	–	MHz
Output Capacitance ($V_{CB} = 10 \text{ Vdc}$, $I_E = 0$, $f = 0.1 \text{ MHz}$)	C_{ob}	–	400	pF
		–	600	
				2N6284 2N6286, 2N6287
Small–Signal Current Gain ($I_C = 10 \text{ Adc}$, $V_{CE} = 3.0 \text{ Vdc}$, $f = 1.0 \text{ kHz}$)	h_{fe}	300	–	–

2. Indicates JEDEC Registered Data.

3. Pulse test: Pulse Width = 300 μs , Duty Cycle = 2%

2N6284 (NPN); 2N6286, 2N6287 (PNP)

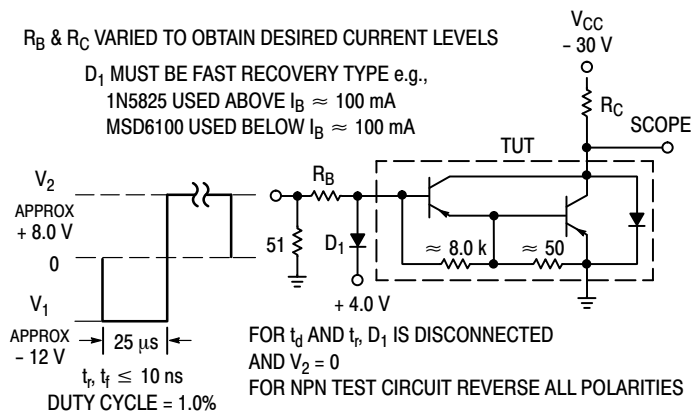

Figure 2. Switching Times Test Circuit

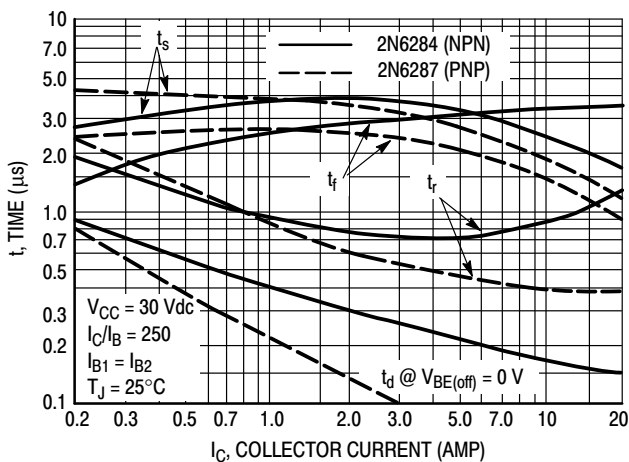

Figure 3. Switching Times



Figure 4. Thermal Response

2N6284 (NPN); 2N6286, 2N6287 (PNP)

ACTIVE-REGION SAFE OPERATING AREA

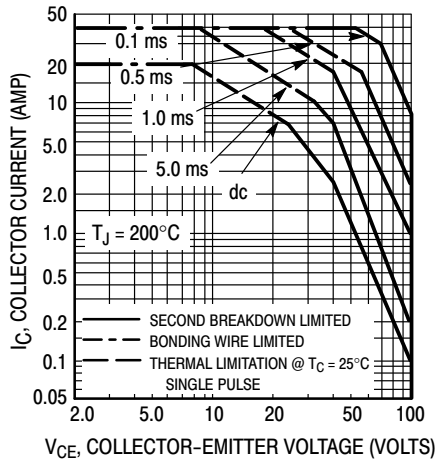

Figure 5. 2N6284, 2N6287

There are two limitations on the power handling ability of a transistor: average junction temperature and second breakdown. Safe operating area curves indicate $I_C - V_{CE}$ limits of the transistor that must be observed for reliable operation; i.e. the transistor must not be subjected to greater dissipation than the curves indicate.

The data of Figure 5 is based on $T_{J(pk)} = 200^\circ\text{C}$; T_C is variable depending on conditions. Second breakdown pulse limits are valid for duty cycles to 10% provided $T_{J(pk)} < 200^\circ\text{C}$. $T_{J(pk)}$ may be calculated from the data in Figure 4. At high case temperatures, thermal limitations will reduce the power that can be handled to values less than the limitations imposed by second breakdown.



Figure 6. Small-Signal Current Gain



Figure 7. Capacitance

2N6284 (NPN); 2N6286, 2N6287 (PNP)

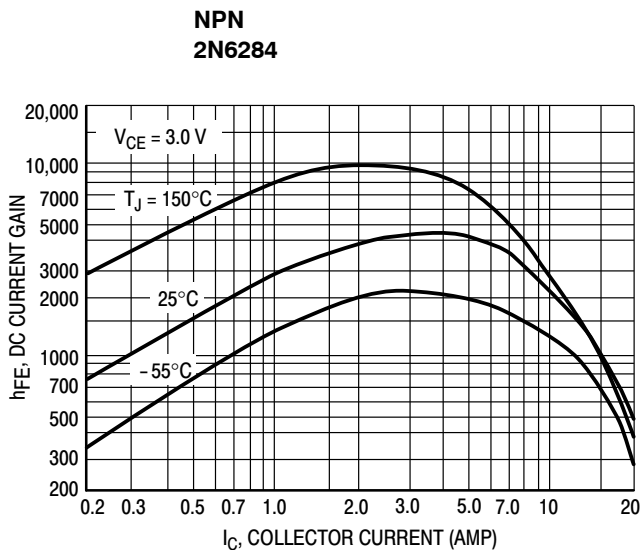

Figure 8. DC Current Gain

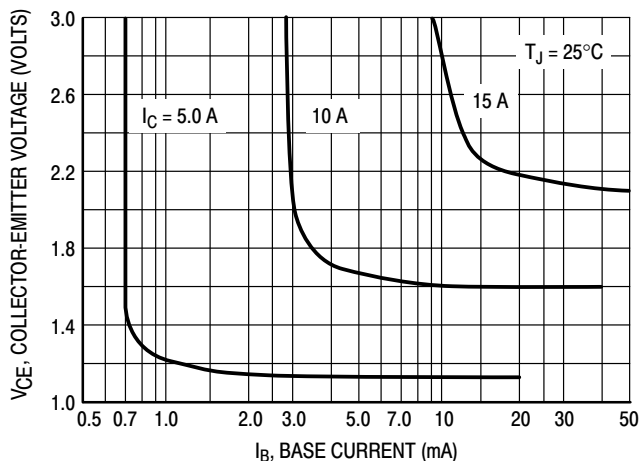
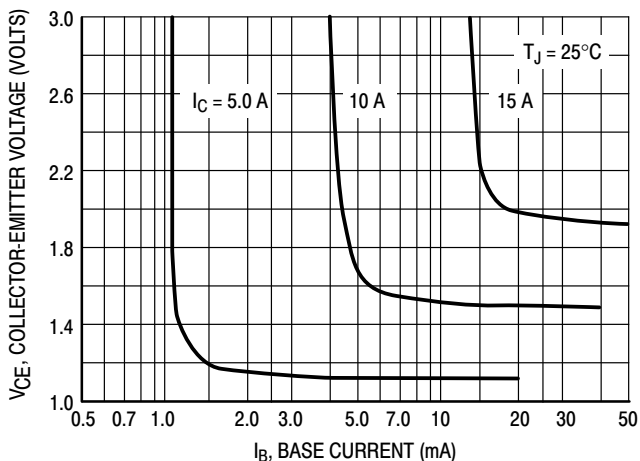

Figure 9. Collector Saturation Region

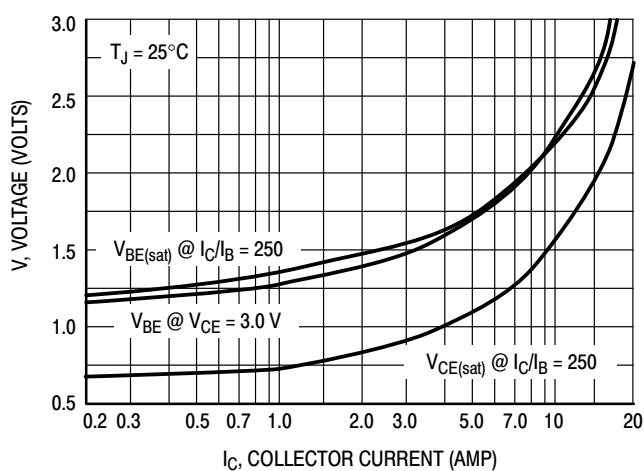
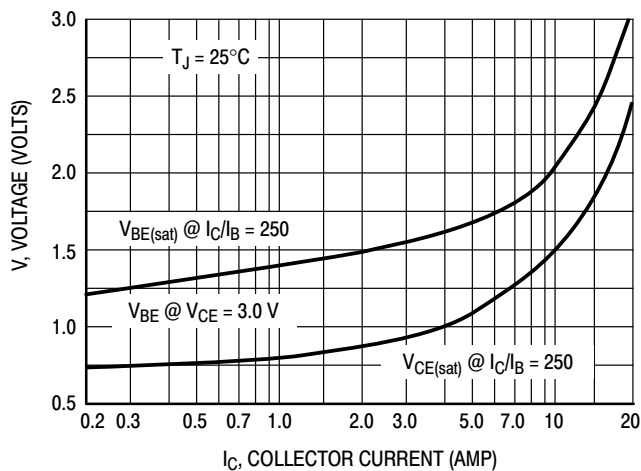

Figure 10. "On" Voltages

2N6284 (NPN); 2N6286, 2N6287 (PNP)

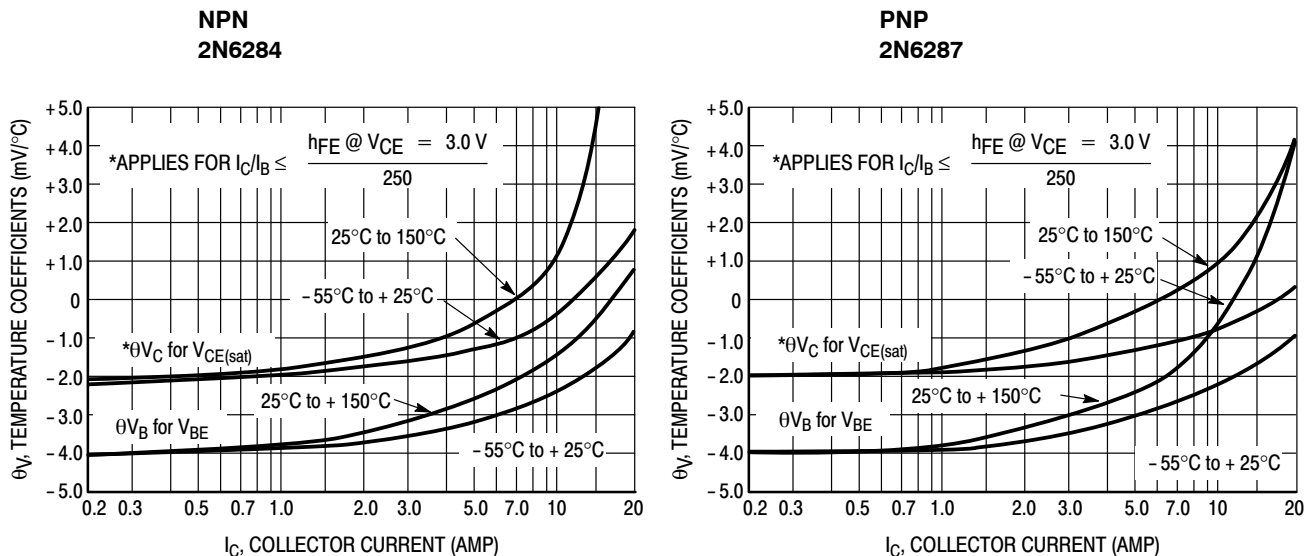

Figure 11. Temperature Coefficients

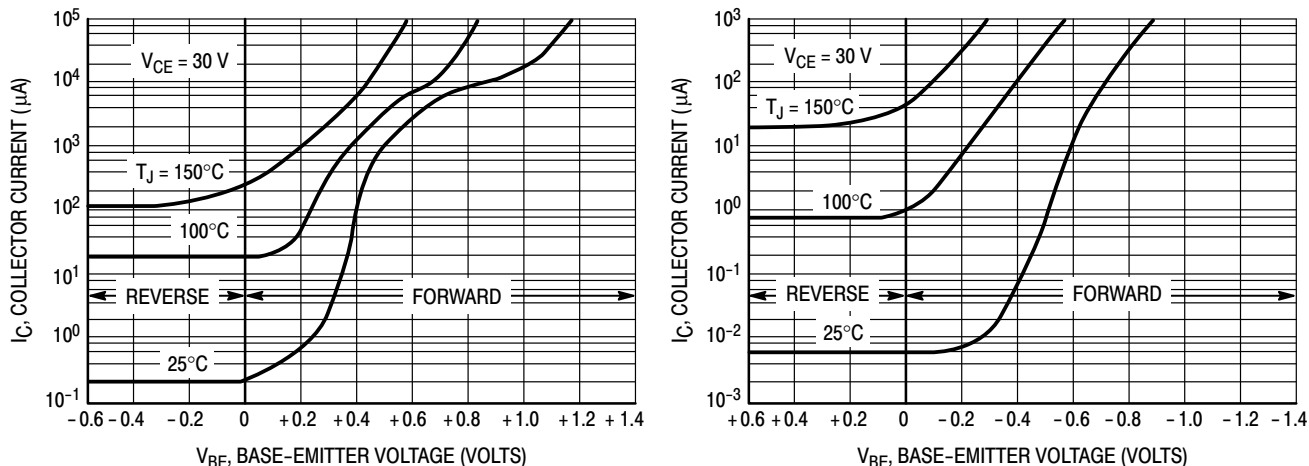

Figure 12. Collector Cut-Off Region

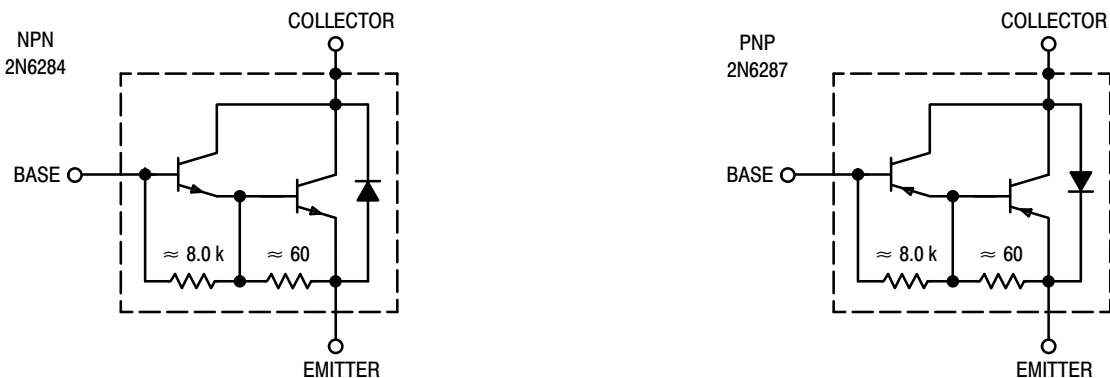

Figure 13. Darlington Schematic

MECHANICAL CASE OUTLINE PACKAGE DIMENSIONS



TO-204 (TO-3) CASE 1-07 ISSUE Z

DATE 05/18/1988

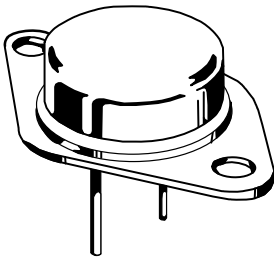

SCALE 1:1

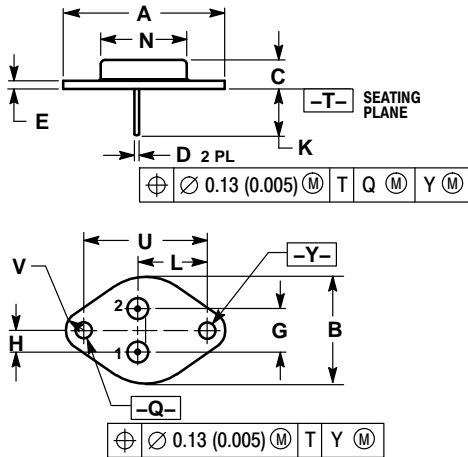

- NOTES:
1. DIMENSIONING AND TOLERANCING PER ANSI Y14.5M, 1982.
 2. CONTROLLING DIMENSION: INCH.
 3. ALL RULES AND NOTES ASSOCIATED WITH REFERENCED TO-204AA OUTLINE SHALL APPLY.

DIM	INCHES		MILLIMETERS	
	MIN	MAX	MIN	MAX
A	1.550 REF	---	39.37 REF	---
B	---	1.050	---	26.67
C	0.250	0.335	6.35	8.51
D	0.038	0.043	0.97	1.09
E	0.055	0.070	1.40	1.77
G	0.430 BSC	---	10.92 BSC	---
H	0.215 BSC	---	5.46 BSC	---
K	0.440	0.480	11.18	12.19
L	---	0.665 BSC	---	16.89 BSC
N	---	0.830	---	21.08
Q	0.151	0.165	3.84	4.19
U	1.187 BSC	---	30.15 BSC	---
V	0.131	0.188	3.33	4.77

- | | | | | |
|--|--|---|---|---|
| <p>STYLE 1:
PIN 1. BASE
2. EMITTER
CASE: COLLECTOR</p> | <p>STYLE 2:
PIN 1. BASE
2. COLLECTOR
CASE: EMITTER</p> | <p>STYLE 3:
PIN 1. GATE
2. SOURCE
CASE: DRAIN</p> | <p>STYLE 4:
PIN 1. GROUND
2. INPUT
CASE: OUTPUT</p> | <p>STYLE 5:
PIN 1. CATHODE
2. EXTERNAL TRIP/DELAY
CASE: ANODE</p> |
| <p>STYLE 6:
PIN 1. GATE
2. EMITTER
CASE: COLLECTOR</p> | <p>STYLE 7:
PIN 1. ANODE
2. OPEN
CASE: CATHODE</p> | <p>STYLE 8:
PIN 1. CATHODE #1
2. CATHODE #2
CASE: ANODE</p> | <p>STYLE 9:
PIN 1. ANODE #1
2. ANODE #2
CASE: CATHODE</p> | |

ON Semiconductor and are trademarks of Semiconductor Components Industries, LLC (SCILLC). SCILLC reserves the right to make changes without further notice to any products herein. SCILLC makes no warranty, representation or guarantee regarding the suitability of its products for any particular purpose, nor does SCILLC assume any liability arising out of the application or use of any product or circuit, and specifically disclaims any and all liability, including without limitation special, consequential or incidental damages. "Typical" parameters which may be provided in SCILLC data sheets and/or specifications can and do vary in different applications and actual performance may vary over time. All operating parameters, including "Typicals" must be validated for each customer application by customer's technical experts. SCILLC does not convey any license under its patent rights nor the rights of others. SCILLC products are not designed, intended, or authorized for use as components in systems intended for surgical implant into the body, or other applications intended to support or sustain life, or for any other application in which the failure of the SCILLC product could create a situation where personal injury or death may occur. Should Buyer purchase or use SCILLC products for any such unintended or unauthorized application, Buyer shall indemnify and hold SCILLC and its officers, employees, subsidiaries, affiliates, and distributors harmless against all claims, costs, damages, and expenses, and reasonable attorney fees arising out of, directly or indirectly, any claim of personal injury or death associated with such unintended or unauthorized use, even if such claim alleges that SCILLC was negligent regarding the design or manufacture of the part. SCILLC is an Equal Opportunity/Affirmative Action Employer.

onsemi, **Onsemi**, and other names, marks, and brands are registered and/or common law trademarks of Semiconductor Components Industries, LLC dba "**onsemi**" or its affiliates and/or subsidiaries in the United States and/or other countries. **onsemi** owns the rights to a number of patents, trademarks, copyrights, trade secrets, and other intellectual property. A listing of **onsemi**'s product/patent coverage may be accessed at www.onsemi.com/site/pdf/Patent-Marking.pdf. **onsemi** reserves the right to make changes at any time to any products or information herein, without notice. The information herein is provided "as-is" and **onsemi** makes no warranty, representation or guarantee regarding the accuracy of the information, product features, availability, functionality, or suitability of its products for any particular purpose, nor does **onsemi** assume any liability arising out of the application or use of any product or circuit, and specifically disclaims any and all liability, including without limitation special, consequential or incidental damages. Buyer is responsible for its products and applications using **onsemi** products, including compliance with all laws, regulations and safety requirements or standards, regardless of any support or applications information provided by **onsemi**. "Typical" parameters which may be provided in **onsemi** data sheets and/or specifications can and do vary in different applications and actual performance may vary over time. All operating parameters, including "Typicals" must be validated for each customer application by customer's technical experts. **onsemi** does not convey any license under any of its intellectual property rights nor the rights of others. **onsemi** products are not designed, intended, or authorized for use as a critical component in life support systems or any FDA Class 3 medical devices or medical devices with a same or similar classification in a foreign jurisdiction or any devices intended for implantation in the human body. Should Buyer purchase or use **onsemi** products for any such unintended or unauthorized application, Buyer shall indemnify and hold **onsemi** and its officers, employees, subsidiaries, affiliates, and distributors harmless against all claims, costs, damages, and expenses, and reasonable attorney fees arising out of, directly or indirectly, any claim of personal injury or death associated with such unintended or unauthorized use, even if such claim alleges that **onsemi** was negligent regarding the design or manufacture of the part. **onsemi** is an Equal Opportunity/Affirmative Action Employer. This literature is subject to all applicable copyright laws and is not for resale in any manner.

ADDITIONAL INFORMATION

TECHNICAL PUBLICATIONS:

Technical Library: www.onsemi.com/design/resources/technical-documentation
onsemi Website: www.onsemi.com

ONLINE SUPPORT: www.onsemi.com/support

For additional information, please contact your local Sales Representative at www.onsemi.com/support/sales

