

## SUMMARY



Image is for illustrative purpose only

### # Wires

Low voltage 30

Series 4B  
Termination type Male crimp  
IP rating 50  
AWG wire size 24.00 - 20.00  
Cable Ø 0.00 - 0.00 mm  
Status active

### Download

[Request a quote](#)  
[Eplan](#)  
[Catalog](#)

## TECHNICAL DETAILS

### Mechanics

Shell Style/Model EC\*: Fixed receptacle with two nuts (back panel mounting)  
Keying 2 keys (alpha=37.5, plug: female contacts, receptacle: male contacts)  
Housing Material Brass (chrome plated [SAE AMS 2460]) shell and collet nut, nickel plated [SAE AMS QQ N 290] brass latch sleeve and mid pieces  
Weight 69.41 g

### Performance

Configuration 4B.330 : 30 Low Voltage  
Insulator Y: PEEK for crimp contacts  
Rated Current 5 Amps

### Specifications

Contact Type: Crimp  
Contact Retention: 30 N  
Contact Dia.: 0.9 mm (0.035in)  
Bucket Dia.: 1.1 mm (0.043in)  
Min. Conductor: 0.25 mm<sup>2</sup> (AWG 24)  
Max. Conductor: 0.5 mm<sup>2</sup> (AWG 20)  
R (max): 4.8 mOhm  
Vtest (contact-shell): 1450 V (AC), 2050 V (DC)

LEMO products and services are provided "as is". LEMO makes no warranties or representations with regard to LEMO product & services or use of them, express, implied or statutory, including for accuracy, completeness, or security. The user is fully responsible for his products and applications using LEMO components.

Vtest (contact-contact): 1750 V (AC), 2500 V (DC)

## Others

Endurance (Shell): 5000  
Temp (min / max): -55°C / +250°C  
Humidity (max): <=95% [at 60 deg C / 140 F]  
Vibration: 15 g [10 Hz - 2000 Hz]  
Shock Resistance: 100 g [ 6 ms]  
Climatical Category: 50/175/21  
Shielding (min): 75 dB (10 MHz)  
Shielding (min): 40 dB (1 GHz)  
Salt Spray Corrosion: >1000 hr

## DRAWINGS

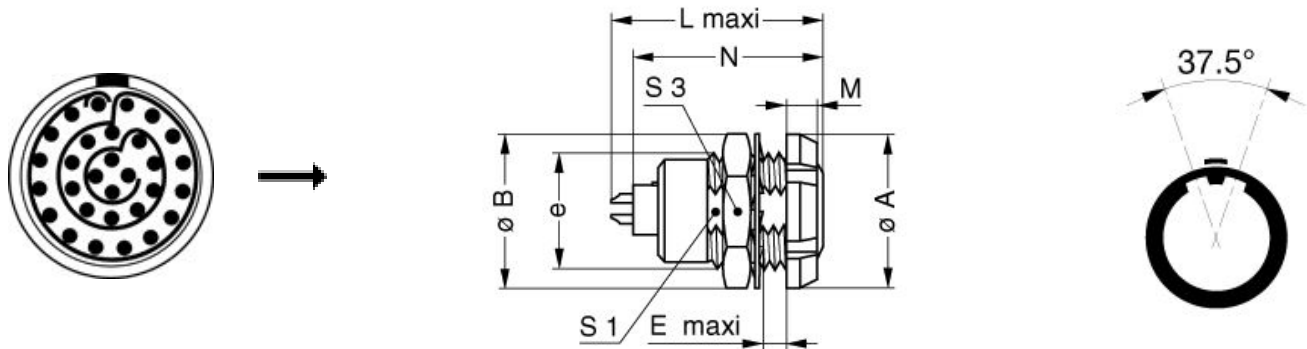

## Dimensions

	A	B	E	L	M	N	S1	S3	e
mm.	30	34	10	35.7	4.5	32.6	23.5	30	M25x1.0
in.	1,18	1,34	0,39	1,41	0,18	1,28	0,93	1,18	







## RECOMMENDED BY LEMO

### Tools

LEMO products and services are provided "as is". LEMO makes no warranties or representations with regard to LEMO product & services or use of them, express, implied or statutory, including for accuracy, completeness, or security. The user is fully responsible for his products and applications using LEMO components.

Crimp Tool: [DPC.91.701.V](#)  
 Crimp settings: AWG/Selector = 20-22-24/6-5-5  
 Positionner: [DCE.91.094.BVC](#)  
 Extractor: [DCC.09.05B.LAG](#)  
 Replacement contact: FGG.4B.560.ZZC  
 Spanner wrench: [Socket for torque wrench DCM.65.270.AZ](#)

## Cables

CMN.30.T22.087PGCE	PVC	GREY	
CMN.30.T22.087PGZE		Grey	
CMN.30.T22.087PNCE	PVC	Black	
CMN.30.T22.087PNZE			
330240	PVC	Black	
330260	PVC	Black	
430250	PVC	Grey	

*LEMO products and services are provided "as is". LEMO makes no warranties or representations with regard to LEMO product & services or use of them, express, implied or statutory, including for accuracy, completeness, or security. The user is fully responsible for his products and applications using LEMO components.*