

125MS28ACMA1STD

Aliases (A902GP125V280A)

Obsolete

MS/A902, Aluminum Electrolytic, 125 uF, -0/+25%, 280 VAC, -20/+60°C

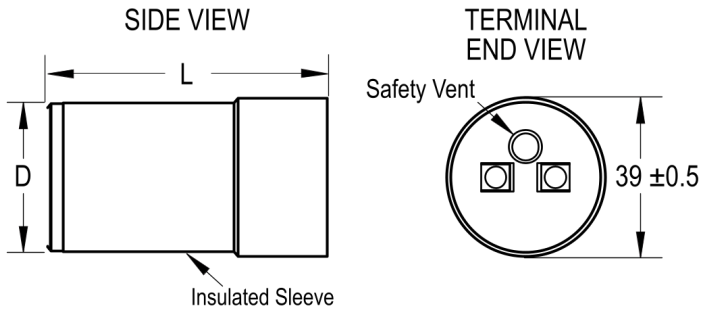

General Information

Series	MS/A902
Dielectric	Aluminum Electrolytic
Description	Motor Start Aluminum Electrolytic
RoHS	Yes
Lead	Quick Connect
AEC-Q200	No
Halogen Free	Yes
Shelf Life	156 Weeks

Specifications

Capacitance	125 uF
Capacitance Tolerance	-0/+25%
Voltage AC	280 VAC
Temperature Range	-20/+60°C
Rated Temperature	60°C
Life	500 Hrs

Dimensions

D	38mm +/-0.5mm
L	116mm MAX

Packaging Specifications

Packaging	Bulk, Bag
-----------	-----------