

Contact Information

525-P.C. Tail, High Point - Tail LG.=.190(4.83)

.156" (3.96mm) Contact Spacing x .200" (5.08mm) Row Spacing

THIS IS A C.A.D. GENERATED DRAWING
DO NOT MAKE MANUAL REVISIONS TO MASTER.



ISSUE NUMBER

ORIGINAL ①

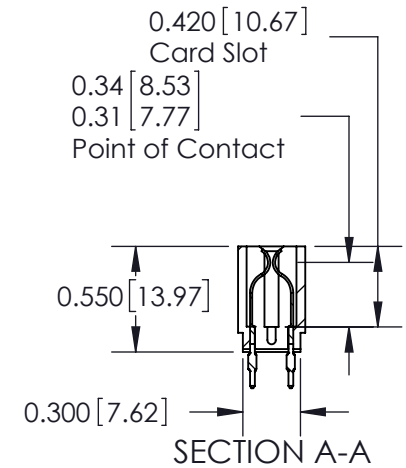
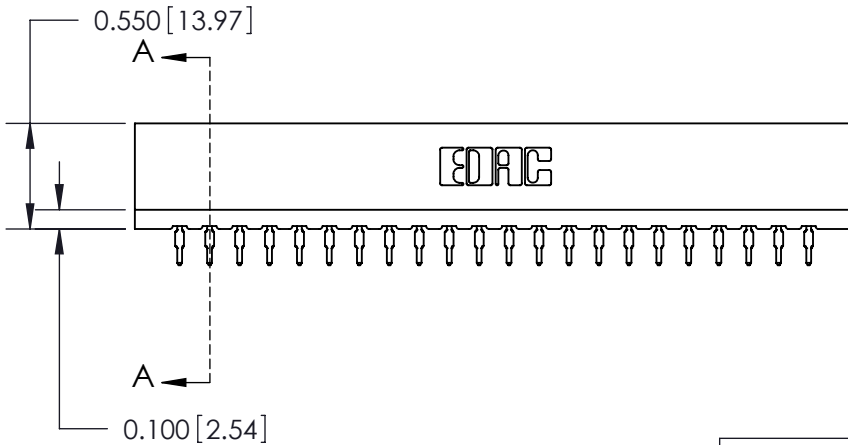
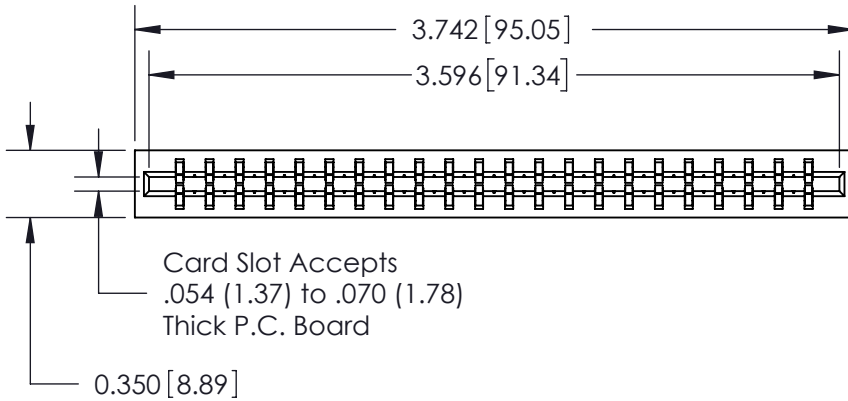

Note:
**MBB switching contacts assembled in
specified positions are available on request.**

717 Series Ultra-Mate Card Edge Connector - Press Fit

Part Number: 717-044-525-201



YOUR CONNECTION TO QUALITY & SERVICE

EDAC INC
TORONTO, ONTARIO
CANADA

THESE DRAWINGS AND SPECIFICATIONS
ARE THE PROPERTY OF EDAC INC. AND
SHALL NOT BE REPRODUCED, OR COPIED
OR USED AS THE BASIS FOR THE
MANUFACTURE OR SALE OF APPARATUS
WITHOUT WRITTEN PERMISSION.

ACAD REFERENCE NO.	717-ENG MASTER	
DRAWN:	J.LEE	DATE: AUG.28/09
CHECKED:	DATE:	
SCALE:	SHEET 1 OF 1	
DRAWING NUMBER	717-ENG MASTER	ISSUE
		1