

# Specification

## Patent Pending

Part No	:	<b>GGBSFTP.45.9.A.08</b>
Product Name	:	45*45*9mm Terrablast Stacked Patch Antenna
Feature	:	GPS L1, GPS L2 and GPS L5 band, GLONASS, Galileo and BeiDou Operation Right-Hand Circularly Polarized Terrablast Patch Single Feed Patch Assembly Ultra-Impact Resistant Tuned for Centre Positioning on a 50*50mm Ground-plane Patent Pending Design <b>RoHS Compliant</b>



## 1. Introduction

The Taoglas GGBSFTP.45.9.A.08 is a 45\*45mm Terrablast GPS L1, GPS L2 and GPS L5, embedded stacked passive patch antenna with 9mm thickness. This patch is made from a revolutionary new material developed to meet the unique needs of the UAV and automotive industries. It uses a patent pending antenna technology which results in much lighter weight and withstands greater impacts.

Typical applicable industries are:

- Transportation
- Defense
- Marine
- Agriculture
- UAV navigation

The antenna has been tuned and tested on a 50\*50mm ground plane, working at GPS 1575.42MHz, 1227.6MHz and 1176.45MHz. This Terrablast patch also operates at other worldwide Navigation systems such as GLONASS, Galileo and BeiDou.

The GGBSFTP.45.9.A.08 is mounted via a pin and double sided adhesive. This antenna works well without modifications in most environment but can be tuned and further optimized to different ground planes and enclosures if this is required. Custom antenna modifications are subject to possible NRE and minimum order quantity.

Terrablast antennas are not suitable for SMD reflow. The correct method is manual soldering at a soldering temperature of 380°C +/- 20°C for a duration of 3 to 5 seconds. All Terrablast antennas undergo rigorous temperature, vibration and impact tests and exceed the highest ISO16750 standards.

For further information, or support to test and integrate Taoglas Terrablast technology please contact your regional Taoglas facility.

## 2. Specification

ELECTRICAL			
	GPS L1	GPS L2	GPS L5
Frequency	1575.42 MHz	1227.6 MHz	1176.45 MHz
Return Loss	≤-10dB	≤-10dB	≤-6dB
Efficiency	63 %	50 %	31 %
Average Gain	-2 dB	-2.9 dB	-4.9 dB
Peak Gain	2.5 dBi typ.	1.1 dBi typ.	-0.8 dBi typ.
Polarization	RHCP	RHCP	RHCP
Impedance	50 Ω	50 Ω	50 Ω
MECHANICAL			
Dimensions	45 x 45 x 9 mm		
Material	Terrablast		
Pin Diameter	0.9 mm		
Pin Length	1.7 mm		
Weight	41.8g		
ENVIRONMENTAL			
Operation Temperature	-30°C to 85°C		
Storage Temperature	-40°C to 95°C		
Humidity	Non-condensing 65°C 95% RH		

\* Antenna properties were measured with the antenna mounted on 50\*50mm Ground Plane.



### 3. Antenna Characteristics

#### 3.1 Return Loss

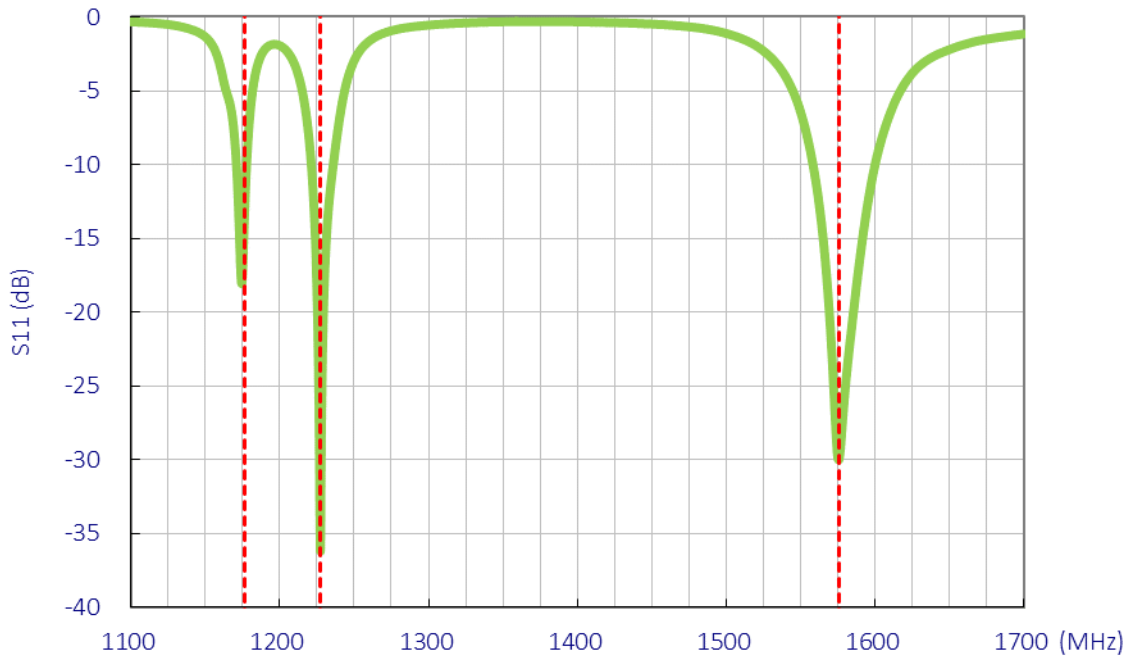

#### 3.2 Efficiency

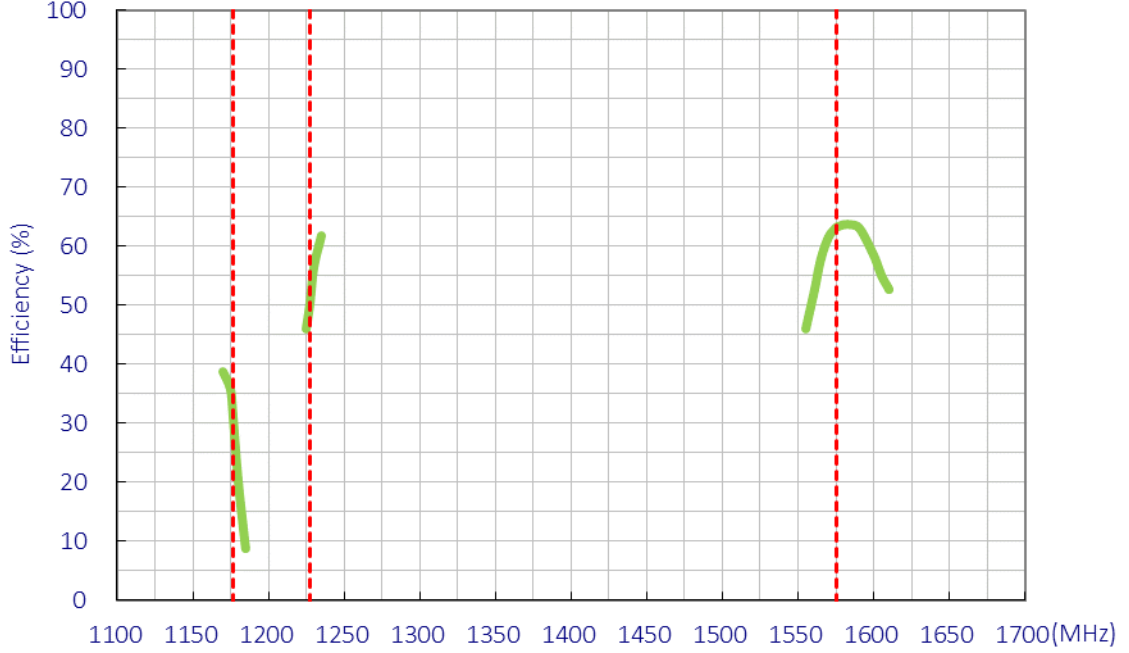

### 3.3 Peak Gain



### 3.4 Average Gain

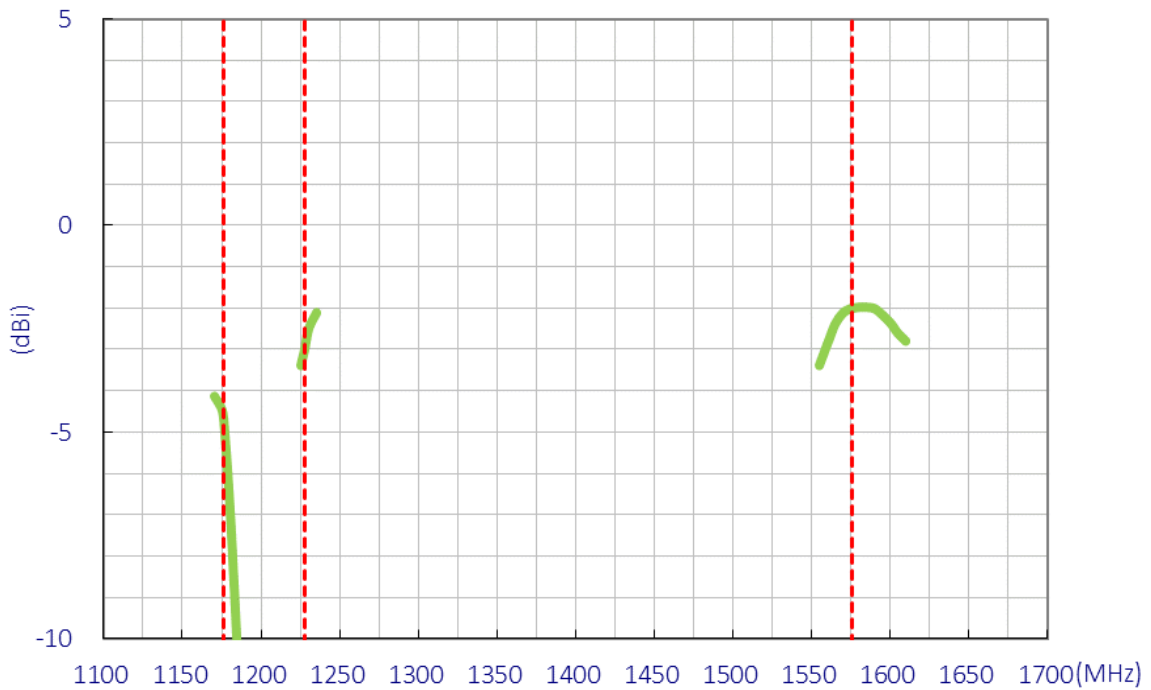

## 4. 2D Antenna Radiation

### 4.1 Test Setup

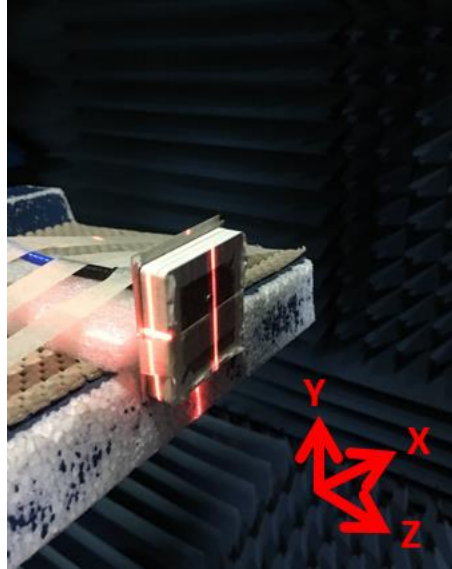

### 4.2 X-Y Plane

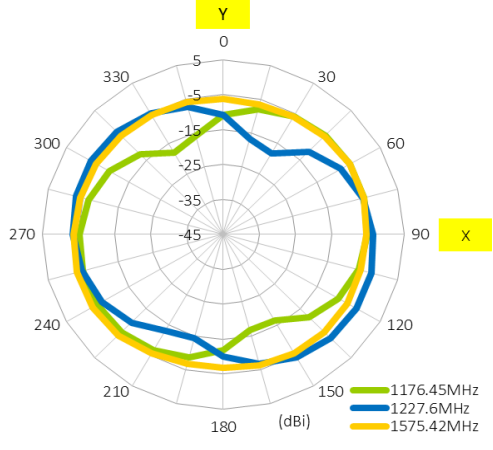

### X-Z Plane

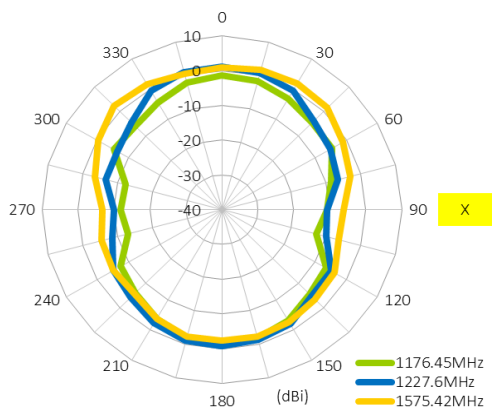

### Y-Z Plane

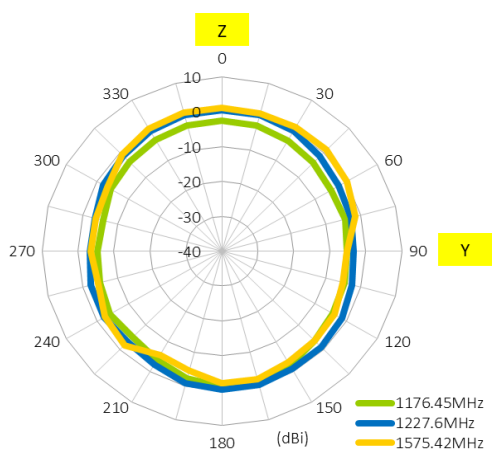

# 5. 3D radiation pattern

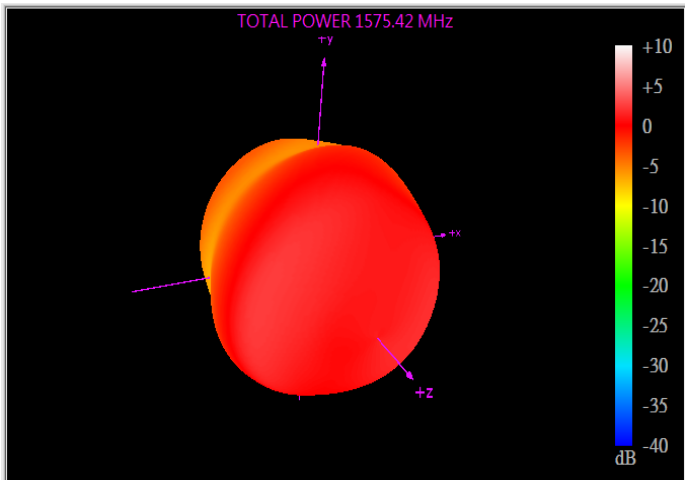
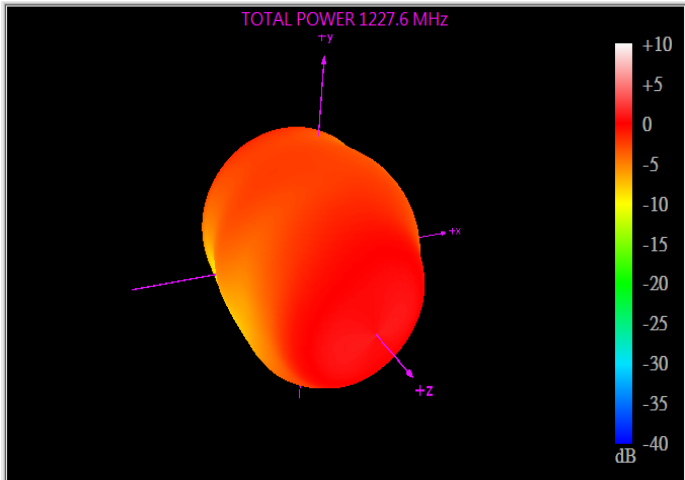
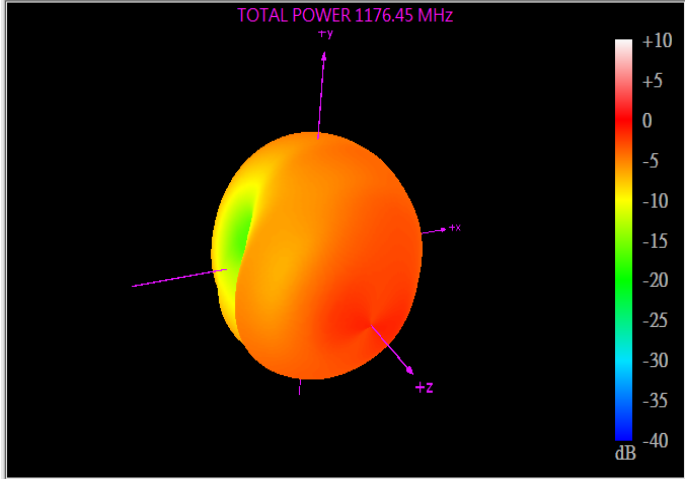



## 6. Mechanical Drawing-Patch

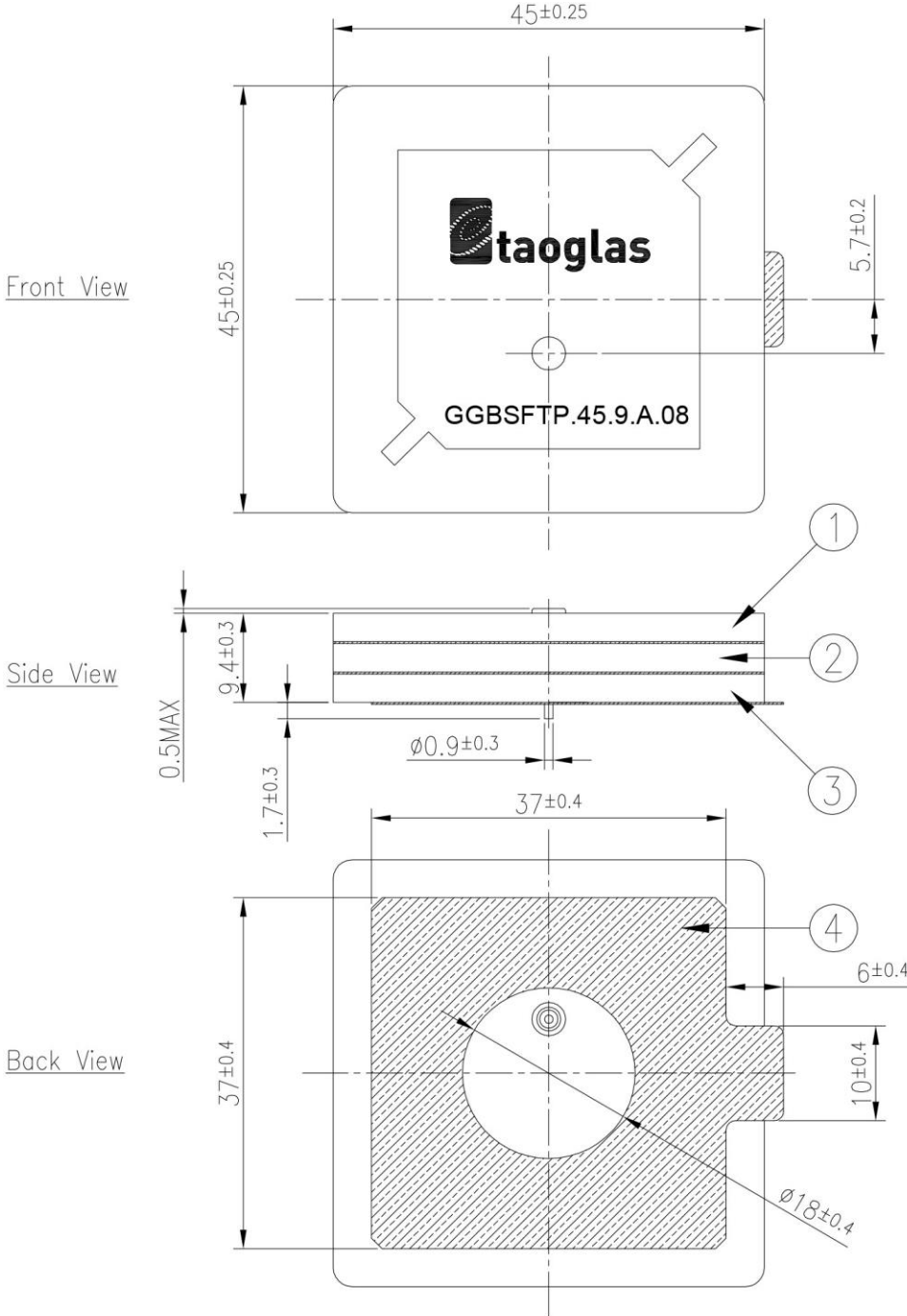

	Name	Material	Finish	QTY
1	Patch-1 (45x45x3mm)	Terrablast	Clear	1
2	Patch-2 (45x45x3mm)	Terrablast	Clear	1
3	Patch-3 (45x45x3mm)	Terrablast	Clear	1
4	Double Sided Adhesive	NITTO 5015	White Liner	1

## 6.1 Adhesive Thickness

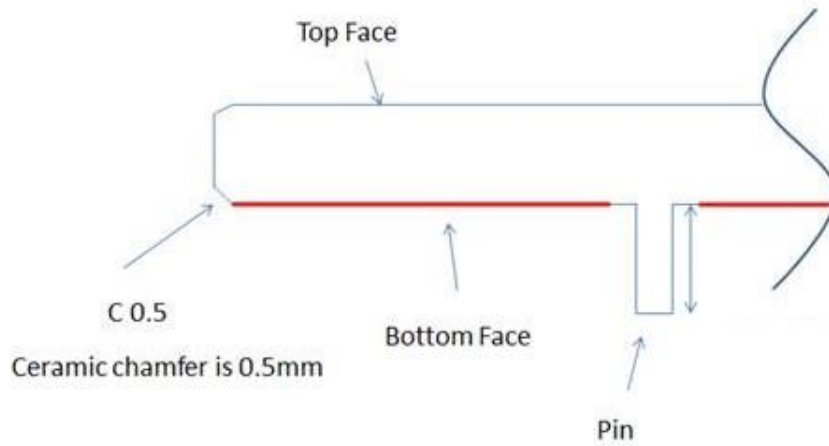

Red Line shows the adhesive without Liner – thickness 0.08~0.1mm

## 7. PCB Footprint Recommendation

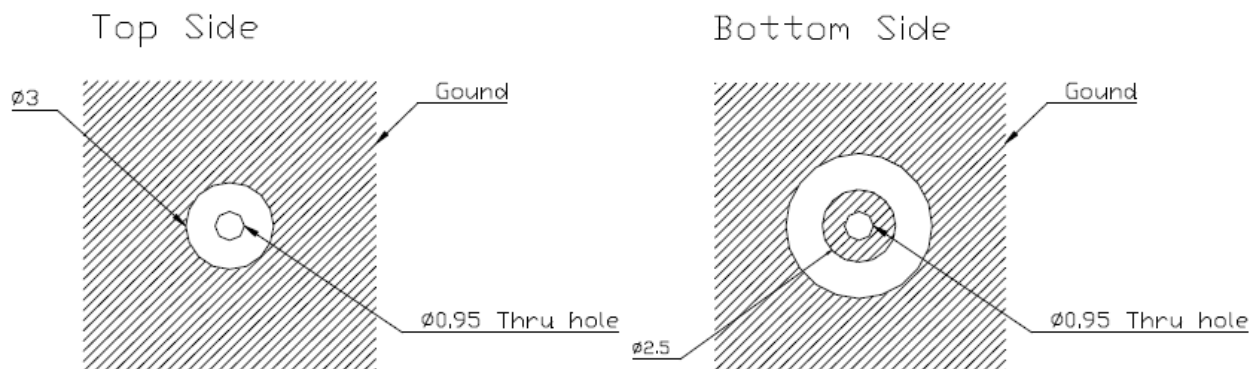

TOL:  $\pm 0.20$   
UNIT: mm

## 8. Packaging

8 pcs GGBSFTP.45.9.A.08 per Tray  
 Tray Dimensions - 255\*144\*12mm  
 Weight - 350g

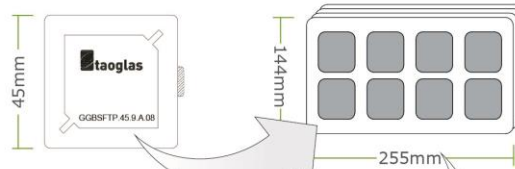

24 pcs GGBSFTP.45.9.A.08 per S Carton  
 Carton Dimensions - 263\*154\*96mm  
 Weight - 1kg

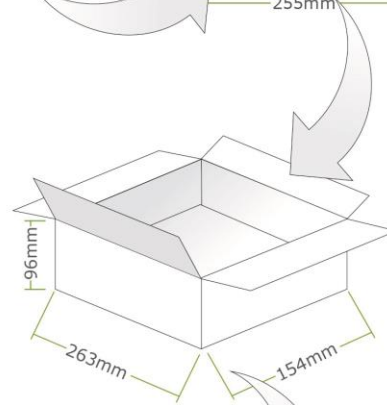

96 pcs GGBSFTP.45.9.A.08 per Large Carton  
 Large Carton Dimensions - 327\*280\*218mm  
 Weight - 4kg

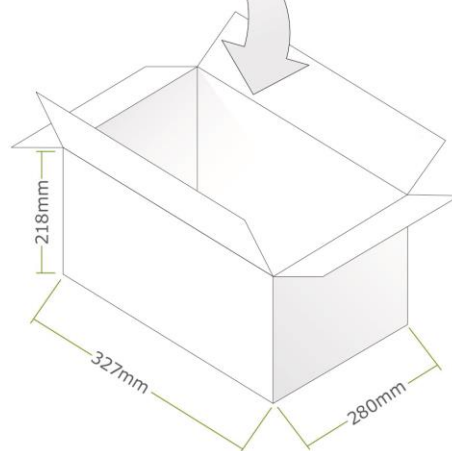

Pallet Dimensions:  
 1200mm\*1000mm\*1280mm  
 36 Cartons per Pallet  
 9 Cartons per Layer, 4 Layers

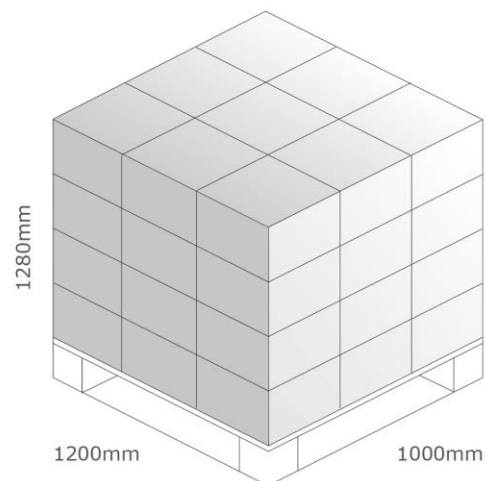

Taoglas makes no warranties based on the accuracy or completeness of the contents of this document and reserves the right to make changes to specifications and product descriptions at any time without notice. Taoglas reserves all rights to this document and the information contained herein. Reproduction, use or disclosure to third parties without express permission is strictly prohibited. Copyright © Taoglas Ltd.