

| TOLERANCE<br>UNLESS OTHERWISE<br>SPECIFIED |       |
|--|-------|
| .X   | ±0.25 |
| .XX  | ±0.13 |
| .XXX                                       | ±0.05 |

THIS IS A C.A.D. GENERATED DRAWING  
DO NOT MAKE MANUAL REVISIONS TO MASTER.

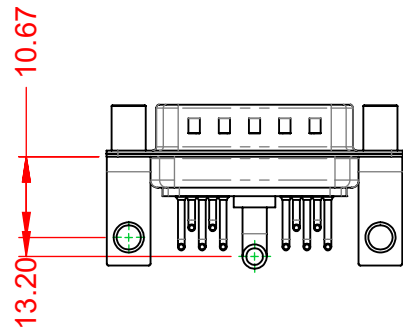

| ISSUE NUMBER |   |
|--------------|---|
| ORIGINAL     | ① |

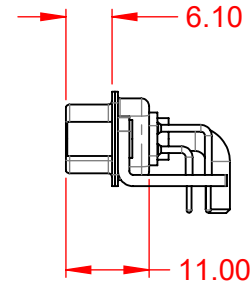
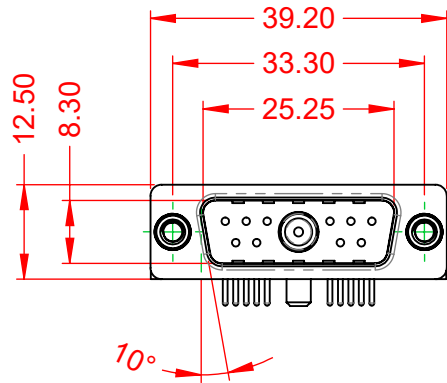

**NOTES:**

**MATERIAL:**  
**HOUSING:** THERMOPLASTIC POLYESTER, UL94V-0  
**SHELL:** STEEL, TIN PLATED  
**CONTACT:** COPPER ALLOY, 30µ" GOLD PLATED

**OPERATING TEMPERATURE:** -55°C ~ 125°C

**POWER/CO-AX CONTACT RATING:** 30A (CURRENT)  
(IF PRESENT)

**SIGNAL CONTACT CURRENT RATING:** 5A PER CONTACT

**SIGNAL CONTACT RESISTANCE:** 10mΩ MAX.

**INSULATOR RESISTANCE:** 5000MΩ min.

**DIELECTRIC WITHSTANDING VOLTAGE:** 1000V AC rms

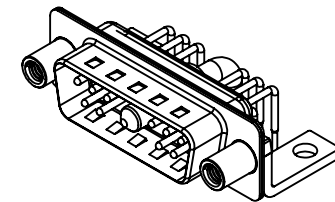

THIS SERIES FULLY CONFORMS TO  
THE EUROPEAN UNION DIRECTIVES  
2011/65/EU FOR RoHS COMPLIANCY.



YOUR CONNECTION TO QUALITY & SERVICE

EDAC INC  
TORONTO, ONTARIO  
CANADA

THESE DRAWINGS AND SPECIFICATIONS  
ARE THE PROPERTY OF EDAC INC., AND  
SHALL NOT BE REPRODUCED, OR COPIED  
OR USED AS THE BASIS FOR THE  
MANUFACTURE OR SALE OF APPARATUS  
WITHOUT WRITTEN PERMISSION.

**COMBINATION D-SUB**

|                                      |                    |
|--------------------------------------|--------------------|
| SW REFERENCE NO.: 629 COMBO ASSEMBLY |                    |
| DRAWN: C.B                           | DATE: JAN. 01/2019 |
| CHECKED:                             | DATE:              |
| SCALE: (IN C.A.D. 1:1)               | SHEET 1 OF 2       |
| DRAWING NUMBER: 629-11W1640-3TE      | ISSUE              |
| PART NUMBER: 629-11W1640-3TE         | 1                  |

| TOLERANCE<br>UNLESS OTHERWISE<br>SPECIFIED |       |
|--|-------|
| .X   | ±0.25 |
| .XX  | ±0.13 |
| .XXX                                       | ±0.05 |

THIS IS A C.A.D. GENERATED DRAWING  
DO NOT MAKE MANUAL REVISIONS TO MASTER.



|              |   |
|--------------|---|
| ISSUE NUMBER |   |
| ORIGINAL     | ① |



|   |  |                                      |                    |
|---|--|--------------------------------------|--------------------|
| <b>COMBINATION D-SUB</b>  |  | SW REFERENCE NO.: 629 COMBO ASSEMBLY |                    |
|   |  | DRAWN: C.B                           | DATE: JAN. 01/2019 |
| <b>EDAC</b><br>EDAC INC<br>TORONTO, ONTARIO<br>CANADA<br>YOUR CONNECTION TO QUALITY & SERVICE |  | CHECKED:                             |                    |
|   |  | DATE:                                |                    |
| <b>EDAC</b><br>EDAC INC<br>TORONTO, ONTARIO<br>CANADA<br>YOUR CONNECTION TO QUALITY & SERVICE |  | SCALE: N.T.S                         | SHEET 2 OF 2       |
|   |  | DRAWING NUMBER: 629-11W1640-3TE      | ISSUE 1            |
| <b>EDAC</b><br>EDAC INC<br>TORONTO, ONTARIO<br>CANADA<br>YOUR CONNECTION TO QUALITY & SERVICE |  | PART NUMBER: 629-11W1640-3TE         |                    |
|   |  | ISSUE 1                              |                    |



THIS SERIES FULLY CONFORMS TO  
THE EUROPEAN UNION DIRECTIVES  
2011/65/EU FOR RoHS COMPLIANCY.

THESE DRAWINGS AND SPECIFICATIONS  
ARE THE PROPERTY OF EDAC INC., AND  
SHALL NOT BE REPRODUCED, OR COPIED  
OR USED AS THE BASIS FOR THE  
MANUFACTURE OR SALE OF APPARATUS  
WITHOUT WRITTEN PERMISSION.