

Data sheet | Item number: 787-860

Electronic circuit breaker; 4-channel; 24 VDC input voltage; adjustable 1 ... 6 A; communication capability; 10,00 mm²

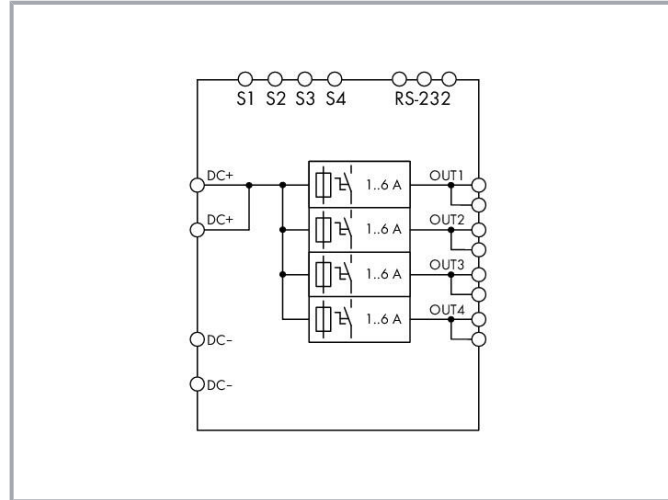

www.wago.com/787-860



Subject to changes. Please also observe the further product documentation!

WAGO GmbH & Co. KG
Hansastr. 27
32423 Minden
Phone: +49571 887-0 | Fax: +49571 887-169
Email: info.de@wago.com | Web: www.wago.com

Do you have any questions about our products?
We are always happy to take your call at +49 (571) 887-44222.

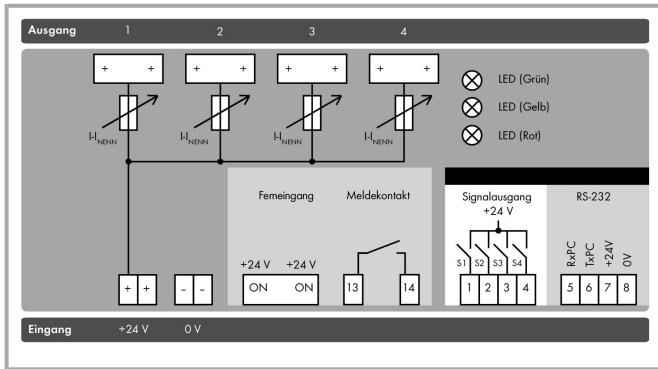

Item description

Features:

- ECB with four channels (parametrizable)
- Time-delayed switching of channels
- Isolated signal contact
- Current and voltage monitoring via RS-232 interface and LCD
- Four active signal outputs for function monitoring

Data

Technical data

Input

Nominal input voltage $U_{i\text{nom}}$	DC 24 V
Input voltage range	DC 18 ... 30 V

Output

Total number of channels (module)	4
Nominal output voltage $U_{o\text{nom}}$	4 x DC 24 V
Output voltage range	DC 18 ... 30 V (U_e - voltage drop)
Voltage drop	≤ 140 mV (6 A) (Input (+))
Nominal output current $I_{o\text{nom}}$	4 x 1 / 2 / 3 / 4 / 5 / 6 A (adjustable for each channel)
Trip time	100 ms ... 600 s (Load-dependent; adjustable; preset: 100 s)
Switch-on capacity	> 20000 μF
Switch-on behavior	Time-delayed channel switching (250 ms each)

Subject to changes. Please also observe the further product documentation!

WAGO GmbH & Co. KG
 Hansastr. 27
 32423 Minden
 Phone: +49571 887-0 | Fax: +49571 887-169
 Email: info.de@wago.com | Web: www.wago.com

Do you have any questions about our products?
 We are always happy to take your call at +49 (571) 887-44222.



Active current limitation	no
---------------------------	----

Signaling and Communication

Signaling	1 x LED DC OK (green) 1 x Warning LED (yellow) 1 x Error LED (red) LCD 1 x Remote control input 1 x RS-232 interface
Operation status indicator	Green LED (all channels OK) Yellow LED (warning) Red LED (at least one channel has tripped)
Communication	RS-232 serial interface
Remote input	Reactivation of all tripped channels via 18 ... 30 VDC pulse for min. 50 ms

Efficiency/power losses

Power loss P_l	$\leq 2 \text{ W}; \leq 5.5 \text{ W}$ (nominal load)
Efficiency (typ.)	96 %

Circuit protection

Internal fuse	T 15 A
---------------	--------

Safety and protection

Protection class	III
Protection type	IP20; per EN 60529
Reverse voltage protection	No
Pollution degree	2
Transient suppression (primary)	Suppressor diode
Parallel operation of single channels	Not permitted
Series operation	No
MTBF	> 500,000 h (per IEC 61709)

Connection data

Connection type 1	Input (+)
Connection technology	Push-in CAGE CLAMP®
WAGO connector	WAGO 831 Series

Subject to changes. Please also observe the further product documentation!



Solid conductor	0.5 ... 10 mm ² / 20 ... 8 AWG
Fine-stranded conductor	0.5 ... 10 mm ² / 20 ... 8 AWG
Strip length	13 ... 15 mm / 0.51 ... 0.59 inches
Connection type 2	Input (-); Output; Signaling
Connection technology 2	CAGE CLAMP®
WAGO connector 2	WAGO 231 Series
Solid conductor 2	0.08 ... 2.5 mm ² / 28 ... 12 AWG
Fine-stranded conductor 2	0.08 ... 2.5 mm ² / 28 ... 12 AWG
Strip length 2	8 ... 9 mm / 0.31 ... 0.35 inches

Physical data

Width	40 mm / 1.575 inches
Height	171 mm / 6.732 inches
Depth from upper-edge of DIN-rail	163 mm / 6.417 inches
Note (dimensions)	Height with connector

Mechanical Data

Mounting type	DIN-35 rail
---------------	-------------

Material Data

Weight	800 g
--------	-------

Environmental requirements

Ambient temperature (operation)	-10 ... +60 °C
Ambient temperature (storage)	-25 ... +85 °C
Relative humidity	5 ... 96 % (no condensation permissible)

Standards and specifications

Conformity marking	CE
Standards/specifications	EN 60950 UL 508 EN 61000-6-2 EN 61000-6-3

Commercial data

Product Group	6 (INTERFACE ELECTRONIC)
---------------	--------------------------

Subject to changes. Please also observe the further product documentation!

WAGO GmbH & Co. KG
Hansastr. 27
32423 Minden
Phone: +49571 887-0 | Fax: +49571 887-169
Email: info.de@wago.com | Web: www.wago.com

Do you have any questions about our products?
We are always happy to take your call at +49 (571) 887-44222.



eCl@ss 10.0	27-37-18-02
eCl@ss 9.0	27-37-18-02
ETIM 8.0	EC001440
ETIM 7.0	EC001440
PU (SPU)	1 pcs
Packaging type	box
Country of origin	DE
GTIN	4045454909888
Customs tariff number	85363010900

Environmental Product Compliance

RoHS Compliance Status	Compliant, No Exemption
------------------------	-------------------------

Approvals / Certificates

General approvals

Logo	Approval	Additional Approval Text	Certificate name
	EAC Brjansker Zertifizierungsstelle	TP TC 020/2011	EAC_Certificate_RU_C-DE.AM02.B.00115_19
	UL Underwriters Laboratories Inc.	UL 508	E255817
	UL Underwriters Laboratories Inc.	UL 60950-1	E255815

Declarations of conformity and manufacturer's declarations

Logo	Approval	Additional Approval Text	Certificate name
	EU-Declaration of Conformity WAGO GmbH & Co. KG	-	-

Optional accessories



Marking accessories

Subject to changes. Please also observe the further product documentation!





WAGO GmbH & Co. KG
 Hansastr. 27
 32423 Minden
 Phone: +49571 887-0 | Fax: +49571 887-169
 Email: info.de@wago.com | Web: www.wago.com

Do you have any questions about our products?
 We are always happy to take your call at +49 (571) 887-44222.

Marking strip

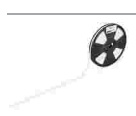
	Item no.: 2009-110 Marking strips; for Smart Printer; on reel; not stretchable; plain; snap-on type; white	www.wago.com/2009-110
	Item no.: 210-831 Marking strips; on reel; 2.3 mm wide; plain; Self-adhesive; white	www.wago.com/210-831
	Item no.: 210-832 Marking strips; on reel; 3 mm wide; plain; Self-adhesive; white	www.wago.com/210-832

Marker

	Item no.: 2009-145 Mini-WSB Inline; for Smart Printer; 1700 pieces on roll; stretchable 5 - 5.2 mm; plain; snap-on type; white	www.wago.com/2009-145
	Item no.: 2009-115 WMB-Inline; for Smart Printer; 1500 pieces on roll; stretchable 5 - 5.2 mm; plain; snap-on type; white	www.wago.com/2009-115
	Item no.: 248-501 Mini-WSB marking card; as card; not stretchable; plain; snap-on type; white	www.wago.com/248-501
	Item no.: 793-501 WMB marking card; as card; not stretchable; plain; snap-on type; white	www.wago.com/793-501
	Item no.: 793-5501 WMB marking card; as card; for terminal block width 5 - 17.5 mm; stretchable 5 - 5.2 mm; plain; snap-on type; white	www.wago.com/793-5501

Cables and pluggable connectors

Communication cable

	Item no.: 787-890 RS-232 communication cable; Length 1.8 m	www.wago.com/787-890
------------------------------------------------------------------------------------	----------------------------------------------------------------------	----------------------------------------------------------------

Connecting cable

	Item no.: 761-9005 USB adapter; with 1m connection cable	www.wago.com/761-9005
------------------------------------------------------------------------------------	--------------------------------------------------------------------	------------------------------------------------------------------

Mounting adapter

Wall-mount adapter

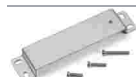
	Item no.: 787-895 Mounting carrier; for screw fixing of 787-8xx devices on mounting plate or wall without DIN 35 rail	www.wago.com/787-895
------------------------------------------------------------------------------------	---------------------------------------------------------------------------------------------------------------------------------	----------------------------------------------------------------

DIN-rail adapter

	Item no.: 787-897 Carrier rail adapter made of zinc die-cast; for mounting 787-8xx devices to a DIN 35 rail	www.wago.com/787-897
------------------------------------------------------------------------------------	-----------------------------------------------------------------------------------------------------------------------	----------------------------------------------------------------

Subject to changes. Please also observe the further product documentation!



Item no.: 787-896
Carrier rail adapter; for mounting 787-8xx devices to a DIN 35 rail

www.wago.com/787-896

Tool

Operating tool



Item no.: 210-721
Operating tool; Blade: 5.5 x 0.8 mm; with a partially insulated shaft; multicoloured

www.wago.com/210-721



Item no.: 210-720
Operating tool; Blade: 3.5 x 0.5 mm; with a partially insulated shaft; multicoloured

www.wago.com/210-720

Ferrule

Ferrule



Item no.: 216-203
Ferrule; Sleeve for 1 mm² / AWG 18; insulated; electro-tin plated; red

www.wago.com/216-203



Item no.: 216-206
Ferrule; Sleeve for 2.5 mm² / AWG 14; insulated; electro-tin plated; blue

www.wago.com/216-206



Item no.: 216-207
Ferrule; Sleeve for 4 mm² / AWG 12; insulated; electro-tin plated; gray

www.wago.com/216-207



Item no.: 216-202
Ferrule; Sleeve for 0.75 mm² / 18 AWG; insulated; electro-tin plated; gray

www.wago.com/216-202



Item no.: 216-204
Ferrule; Sleeve for 1.5 mm² / AWG 16; insulated; electro-tin plated; black

www.wago.com/216-204



Item no.: 216-205
Ferrule; Sleeve for 2.08 mm² / AWG 14; insulated; electro-tin plated; yellow

www.wago.com/216-205



Item no.: 216-208
Ferrule; Sleeve for 6 mm² / AWG 10; insulated; electro-tin plated; electrolytic copper; gastight crimped; acc. to DIN 46228, Part 4/09.90; yellow

www.wago.com/216-208



Item no.: 216-201
Ferrule; Sleeve for 0.5 mm² / 20 AWG; insulated; electro-tin plated; white

www.wago.com/216-201



Item no.: 216-223
Ferrule; Sleeve for 1 mm² / AWG 18; insulated; electro-tin plated; red

www.wago.com/216-223



Item no.: 216-241
Ferrule; Sleeve for 0.5 mm² / 20 AWG; insulated; electro-tin plated; electrolytic copper; gastight crimped; acc. to DIN 46228, Part 4/09.90; white

www.wago.com/216-241



Item no.: 216-242
Ferrule; Sleeve for 0.75 mm² / 18 AWG; insulated; electro-tin plated; electrolytic copper; gastight crimped; acc. to DIN 46228, Part 4/09.90; gray

www.wago.com/216-242



Item no.: 216-222

www.wago.com/216-222

Subject to changes. Please also observe the further product documentation!

Ferrule; Sleeve for 0.75 mm² / 18 AWG; insulated; electro-tin plated; gray

	Item no.: 216-221 Ferrule; Sleeve for 0.5 mm ² / 20 AWG; insulated; electro-tin plated; white	www.wago.com/216-221
	Item no.: 216-224 Ferrule; Sleeve for 1.5 mm ² / AWG 16; insulated; electro-tin plated; black	www.wago.com/216-224
	Item no.: 216-243 Ferrule; Sleeve for 1 mm ² / AWG 18; insulated; electro-tin plated; electrolytic copper; gastight crimped; acc. to DIN 46228, Part 4/09.90; red	www.wago.com/216-243
	Item no.: 216-244 Ferrule; Sleeve for 1.5 mm ² / AWG 16; insulated; electro-tin plated; electrolytic copper; gastight crimped; acc. to DIN 46228, Part 4/09.90; black	www.wago.com/216-244
	Item no.: 216-263 Ferrule; Sleeve for 1 mm ² / AWG 18; insulated; electro-tin plated; electrolytic copper; gastight crimped; acc. to DIN 46228, Part 4/09.90; red	www.wago.com/216-263
	Item no.: 216-246 Ferrule; Sleeve for 2.5 mm ² / AWG 14; insulated; electro-tin plated; electrolytic copper; gastight crimped; acc. to DIN 46228, Part 4/09.90; blue	www.wago.com/216-246
	Item no.: 216-266 Ferrule; Sleeve for 2.5 mm ² / AWG 14; insulated; electro-tin plated; electrolytic copper; gastight crimped; acc. to DIN 46228, Part 4/09.90; blue	www.wago.com/216-266
	Item no.: 216-264 Ferrule; Sleeve for 1.5 mm ² / AWG 16; insulated; electro-tin plated; electrolytic copper; gastight crimped; acc. to DIN 46228, Part 4/09.90; black	www.wago.com/216-264
	Item no.: 216-284 Ferrule; Sleeve for 1.5 mm ² / AWG 16; insulated; electro-tin plated; electrolytic copper; gastight crimped; acc. to DIN 46228, Part 4/09.90; black	www.wago.com/216-284
	Item no.: 216-286 Ferrule; Sleeve for 2.5 mm ² / AWG 14; insulated; electro-tin plated; electrolytic copper; gastight crimped; acc. to DIN 46228, Part 4/09.90; blue	www.wago.com/216-286
	Item no.: 216-287 Ferrule; Sleeve for 4 mm ² / AWG 12; insulated; electro-tin plated; electrolytic copper; gastight crimped; acc. to DIN 46228, Part 4/09.90; gray	www.wago.com/216-287
	Item no.: 216-262 Ferrule; Sleeve for 0.75 mm ² / 18 AWG; insulated; electro-tin plated; electrolytic copper; gastight crimped; acc. to DIN 46228, Part 4/09.90; gray	www.wago.com/216-262
	Item no.: 216-288 Ferrule; Sleeve for 6 mm ² / AWG 10; insulated; electro-tin plated; electrolytic copper; gastight crimped; acc. to DIN 46228, Part 4/09.90; yellow	www.wago.com/216-288
	Item no.: 216-301 Ferrule; Sleeve for 0.25 mm ² / AWG 24; insulated; electro-tin plated; yellow	www.wago.com/216-301
	Item no.: 216-321 Ferrule; Sleeve for 0.25 mm ² / AWG 24; insulated; electro-tin plated; yellow	www.wago.com/216-321
	Item no.: 216-322 Ferrule; Sleeve for 0.34 mm ² / 22 AWG; insulated; electro-tin plated; light turquoise	www.wago.com/216-322

Subject to changes. Please also observe the further product documentation!



Item no.: 216-267

Ferrule; Sleeve for 4 mm² / AWG 12; insulated; electro-tin plated; electrolytic copper; gastight crimped; acc. to DIN 46228, Part 4/09.90; gray www.wago.com/216-267



Item no.: 216-302

Ferrule; Sleeve for 0.34 mm² / 22 AWG; insulated; electro-tin plated; light turquoise www.wago.com/216-302

Downloads

Documentation

Bid Text

787-860 docx - Datei	2019 Jul 3	docx 19.0 kB	Download
-------------------------	------------	-----------------	----------

787-860 X81 - Datei	2019 Jul 3	xml 7.3 kB	Download
------------------------	------------	---------------	----------

Instruction Leaflet

EPSITRON Electronic Circuit Breaker 4 x DC 24 V, 1...6 A		pdf 439.4 kB	Download
-------------------------------------------------------------	--	-----------------	----------

Additional Information

Disposal and Recycling Electrical and electronic equipment, Batteries, Packaging	V 1.1.0 2022 Aug 18	pdf 2.2 MB	Download
-------------------------------------------------------------------------------------	------------------------	---------------	----------

Libraries

Library

Anbindung Stromversorgungen Serie 787 Die Bibliothek "WagoLib787_01.lib" stellt Funktionsbausteine und Visualisierungen zur Verfügung, mit deren Hilfe die Informationen der WAGO Stromversorgungsmodule der Serie 787 angezeigt werden können.	1.3.0 2014 May 14	zip 562.7 kB	Download
----------------------------------------------------------------------------------------------------------------------------------------------------------------------------------------------------------------------------------------------------	----------------------	-----------------	----------

Engineering-Software

Configuration and Commissioning Software

WAGO Software 759-860 Software 759-860, for configuration and visualization of electronic circuit breakers 787-860, 787-861 und 787-862	1.2.6 2012 Feb 16	zip 521.5 kB	Download
--------------------------------------------------------------------------------------------------------------------------------------------	----------------------	-----------------	----------

Subject to changes. Please also observe the further product documentation!



CAD/CAE-Data

CAD data

2D/3D Models 787-860	URL	Download
----------------------	---------------------	--------------------------

CAE data

WSCAD Universe 787-860	URL	Download
------------------------	---------------------	--------------------------

ZUKEN Portal 787-860	URL	Download
----------------------	---------------------	--------------------------

EPLAN Data Portal 787-860	URL	Download
---------------------------	---------------------	--------------------------

Environmental Product Compliance

Compliance Search

Environmental Product Compliance 787-860	URL	Download
------------------------------------------	---------------------	--------------------------

Electronic circuit breaker; 4-channel; 24 VDC input voltage; adjustable 1 ... 6 A; communication capability; 10,00 mm²

Installation Notes

Subject to changes. Please also observe the further product documentation!