

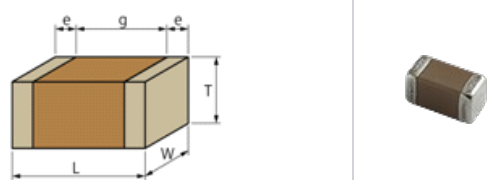

< List of part numbers with package codes >

GCM3195C2A242JA16D , GCM3195C2A242JA16J

**Shape**



L size	3.2 ±0.15mm
W size	1.6 ±0.15mm
T size	0.85 ±0.1 mm
External terminal width e	0.3 to 0.8mm
Distance between external terminals g	1.5mm min.
Size code in inch(mm)	1206 (3216M)

**Notes**

Please use replacements or Recommended.

**References**

Packaging	Specifications	Minimum quantity
D	φ180mm Paper taping	4000
J	φ330mm Paper taping	10000

Mass (typ.)	
1 piece	19.0mg
φ180mm Reel	191g

**Specifications**

Capacitance	2400pF ±5%
Rated voltage	100Vdc
Temperature characteristics (complied standard)	C0G(EIA)
Temperature coefficient	0±30ppm/°C
Temperature range of temperature characteristics	25 to 125°C
Operating temperature range	-55 to 125°C

**Attention**

- 1.This datasheet is downloaded from the website of Murata Manufacturing Co., Ltd. Therefore, it's specifications are subject to change or our products in it may be discontinued without advance notice. Please check with our sales representatives or product engineers before ordering.
- 2.This datasheet has only typical specifications because there is no space for detailed specifications. Therefore, please review our product specifications or consult the approval sheet for product specifications before ordering.