

Cable feed-through sleeve - HC-KDT 8-9 - 1644083

Please be informed that the data shown in this PDF Document is generated from our Online Catalog. Please find the complete data in the user's documentation. Our General Terms of Use for Downloads are valid (<http://phoenixcontact.com/download>)



Cable feed-through sleeves, for cable diameters of 8 - 9 mm, a cable binder can be used as strain relief



Key Commercial Data

Packing unit	10 pc
Minimum order quantity	10 pc
GTIN	 4 017918 895945
GTIN	4017918895945

Technical data

Ambient conditions

Degree of protection	IP54
Ambient temperature (operation)	-40 °C ... 125 °C

General

Material	Thermoplastic rubber
Flammability rating according to UL 94	HB
Color	black

Standards and Regulations

Flammability rating according to UL 94	HB
--	----

Environmental Product Compliance

China RoHS	Environmentally friendly use period: unlimited = EFUP-e
	No hazardous substances above threshold values

Drawings

Cable feed-through sleeve - HC-KDT 8-9 - 1644083

Dimensional drawing

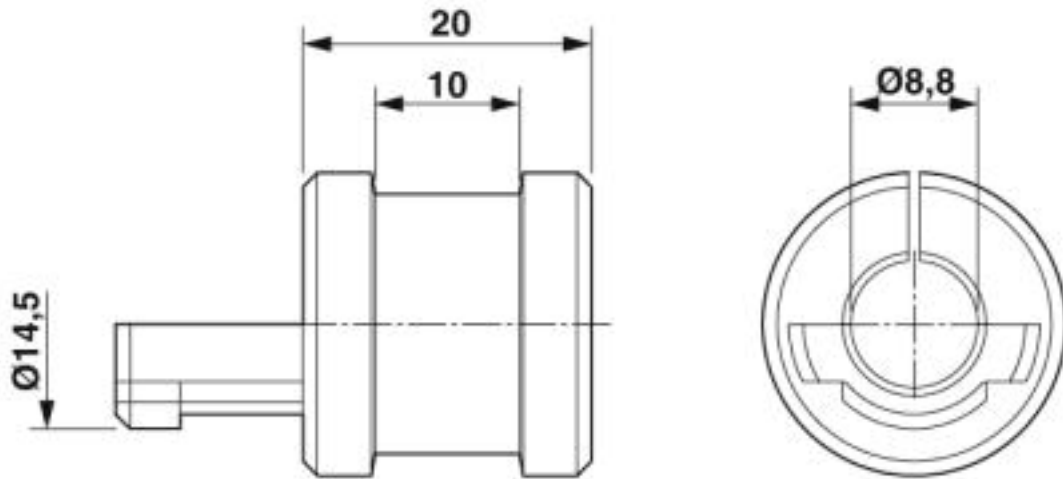

Dimensional drawing

Approvals

Approvals

Approvals

EAC

Ex Approvals

Approval details

EAC		RU C- DE.AI30.B.01102
-----	--	--------------------------

Phoenix Contact 2019 © - all rights reserved
<http://www.phoenixcontact.com>

PHOENIX CONTACT GmbH & Co. KG
Flachsmarktstr. 8
32825 Blomberg
Germany
Tel. +49 5235 300
Fax +49 5235 3 41200
<http://www.phoenixcontact.com>