

3D Hall click

2. Soldering the headers

Before using your click board™, make sure to solder 1x8 male headers to both left and right side of the board. Two 1x8 male headers are included with the board in the package.

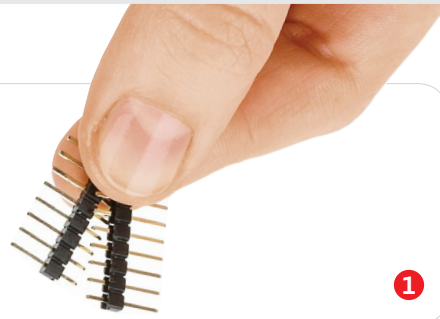

2

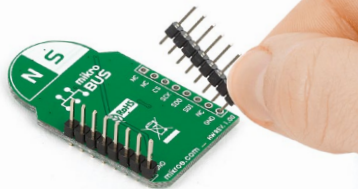

Turn the board upside down so that the bottom side is facing you upwards. Place shorter pins of the header into the appropriate soldering pads.

3

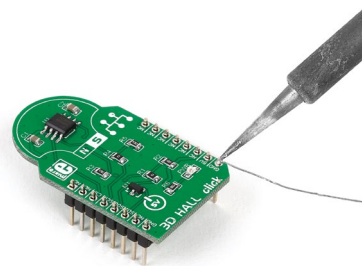

Turn the board upward again. Make sure to align the headers so that they are perpendicular to the board, then solder the pins carefully.

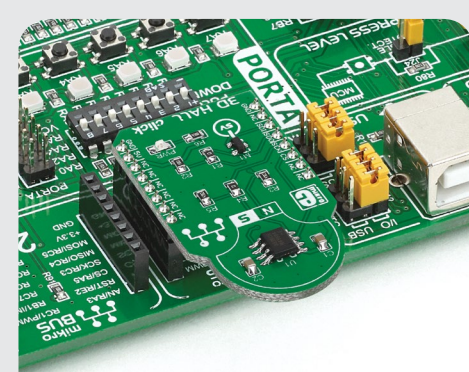

4. Essential features

3D Hall click functions as a contactless position sensor for any type of magnet, capable of measuring its rotational, linear and 3D displacement with a high degree of precision. It can be applied in designing robust long-lasting joysticks, knobs, valves, throttles, robotic components or M2M interfaces. The contactless coupling would make such a design resistant against wear and environmental contaminants such as dirt and dust. The sensor outputs 16-bit resolution positional data. **Each MLX90333 IC has a 40 bit ID number.**

1. Introduction

3D Hall click carries the **MLX90333 Triaxis™** Hall sensor, capable of detecting the position of any magnet in nearby space. It does so by being sensitive to three components of flux density [BX, BY, BZ]. The on-chip signal processing circuitry simplifies integration. The board communicates with the target MCU through the mikroBUS™ SPI interface [CS, SCK, MISO, MOSI]. 3D Hall click is designed to use a 5V power supply only.

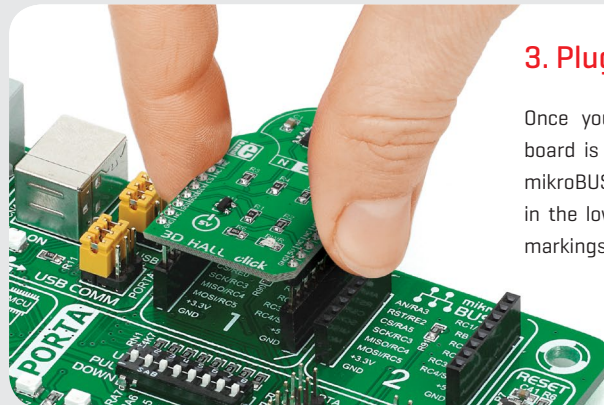

3. Plugging the board in

Once you have soldered the headers your board is ready to be placed into the desired mikroBUS™ socket. Make sure to align the cut in the lower-right part of the board with the markings on the silkscreen at the mikroBUS™ socket. If all the pins are aligned correctly, push the board all the way into the socket.

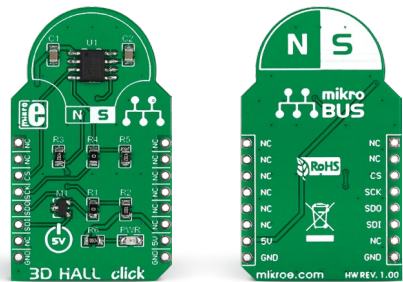

click
BOARDS™
www.mikroe.com

3D Hall click Manual v1.00

0100000089125

5. Schematic

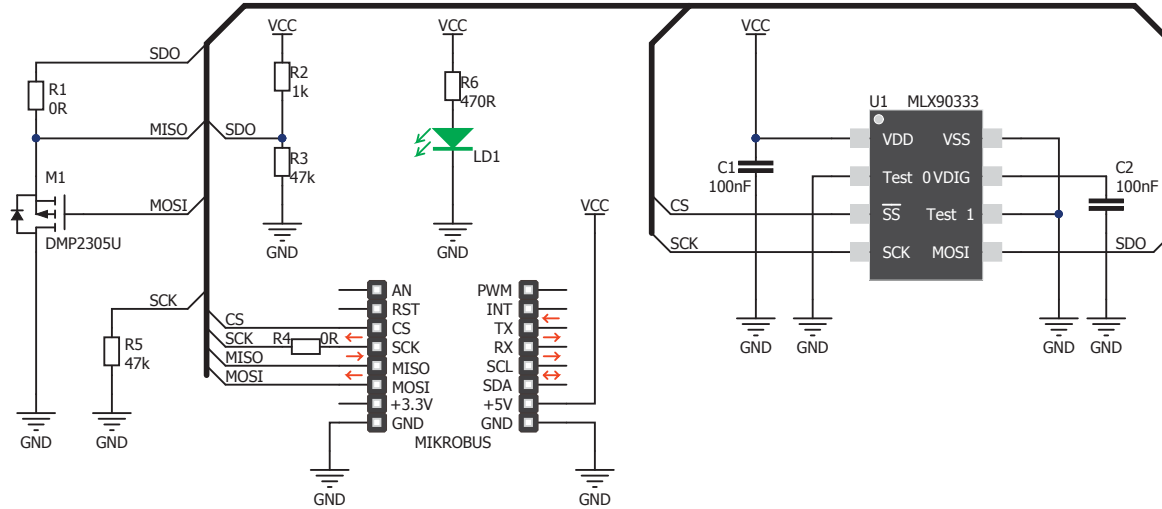

6. Dimensions

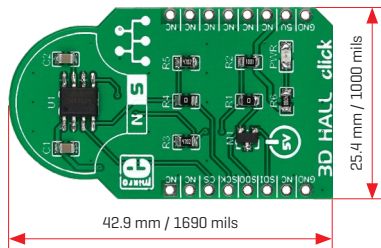

	mm	mils
LENGTH	42.9	1690
WIDTH	25.4	1000
HEIGHT*	3.9	154

* without headers

7. 3D Hall click alternatives

Several different types of Hall effect-based sensors are also available on click boards™. Check out LIN HALL click, UNI HALL click, and BI-HALL click. Visit the click board™ page for more info: www.mikroe.com/click

8. Code examples

Once you have done all the necessary preparations, it's time to get your click board™ up and running. We have provided examples for mikroC™, mikroBasic™ and mikroPascal™ compilers on our **Libstock** website. Just download them and you are ready to start.



9. Support

MikroElektronika offers **free tech support** [www.mikroe.com/support] until the end of the product's lifetime, so if something goes wrong, we're ready and willing to help!



10. Disclaimer

MikroElektronika assumes no responsibility or liability for any errors or inaccuracies that may appear in the present document. Specification and information contained in the present schematic are subject to change at any time without notice.

Copyright © 2015 MikroElektronika.
All rights reserved.