

Power Metal Strip® Resistors, High Power, Surface-Mount, 4-Terminal

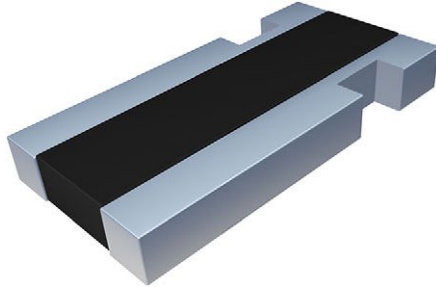

LINKS TO ADDITIONAL RESOURCES



FEATURES

- 4-terminal design
- All welded construction of the Power Metal Strip® resistors are ideal for all types of current sensing, voltage division, and pulse applications
- Proprietary processing technique produces low resistance values
- Solid metal nickel-chrome and manganese-copper alloy resistive element with low TCR (< 20 ppm/°C)
- Sulfur resistance by construction that is unaffected by high sulfur environments
- Low thermal EMF (< 3 μV/°C)
- AEC-Q200 qualified ⁽¹⁾
- PATENT(S): www.vishay.com/patents
- Material categorization: for definitions of compliance please see www.vishay.com/doc?99912



Notes

- * This datasheet provides information about parts that are RoHS-compliant and / or parts that are non-RoHS-compliant. For example, parts with lead (Pb) terminations are not RoHS-compliant. Please see the information / tables in this datasheet for details
- Follow link to Overview of Automotive Grade Products for more details: www.vishay.com/doc?49924
- ⁽¹⁾ Flame retardance test may not be applicable to some resistor technologies

STANDARD ELECTRICAL SPECIFICATIONS

GLOBAL MODEL	SIZE	POWER RATING $P_{70^{\circ}\text{C}}$ W	TOLERANCE ± %	RESISTANCE VALUE RANGE ⁽¹⁾ Ω	WEIGHT (typical) g/1000 pieces
WSKW0612	0612	1.0	1.0, 5.0	0.5m to 5m	8.5

Note

- ⁽¹⁾ Other values may be available, contact factory

GLOBAL PART NUMBER INFORMATION

Global Part Numbering Example: WSKW06121L000FEA (visit www.vishay.net Vishay Dale parts numbering manual for all options)

W S K W 0 6 1 2 1 L 0 0 0 F E A

GLOBAL MODEL (8 digits)	RESISTANCE VALUE ⁽¹⁾ (5 digits)	TOLERANCE CODE (1 digit)	PACKAGING CODE ⁽²⁾ (2 digits)	SPECIAL ⁽³⁾ (up to 2 digits)
WSKW0612	L = mΩ 1L000 = 0.001 Ω 2L000 = 0.002 Ω 3L000 = 0.003 Ω	F = ± 1.0 % J = ± 5.0 %	EA = lead (Pb)-free, tape / reel EK = lead (Pb)-free, bulk	(dash number) from 1 to 99 as applicable

Notes

- ⁽¹⁾ WSL marking (www.vishay.com/doc?30327)
- ⁽²⁾ Packaging code: EB (lead (Pb)-free) are non-standard packaging codes designating 1000 piece reels. These non-standard packaging codes are identical to our standard EA (lead (Pb)-free), except that they have a package quantity of 1000 pieces
- ⁽³⁾ Follow link for customization capabilities: www.vishay.com/doc?48163

PATENT(S): www.vishay.com/patents

This Vishay product is protected by one or more United States and international patents.

TECHNICAL SPECIFICATIONS		
PARAMETER	UNIT	RESISTOR CHARACTERISTICS
Component temperature coefficient (including terminal) ⁽¹⁾ TCR measured from -55 °C to 150 °C	ppm/°C	-300 / +50 for 0.5 mΩ to 0.99 mΩ
		± 150 for 1 mΩ and 2 mΩ
		± 75 for 3 mΩ to 5 mΩ
Element TCR ⁽²⁾	ppm/°C	< 20
Operating temperature range	°C	-65 to +170
Maximum working voltage ⁽³⁾	V	$(P \times R)^{1/2}$

Notes

- TCR for Current Sensing (white paper): www.vishay.com/doc?30405
- (1) Component TCR - total TCR that includes the TCR effects of the resistor element and the copper terminal
- (2) Element TCR - only applies to the alloy used for the resistor element
- (3) Maximum working voltage - the WSL is not voltage sensitive, but is limited by power / energy dissipation and is also not ESD sensitive

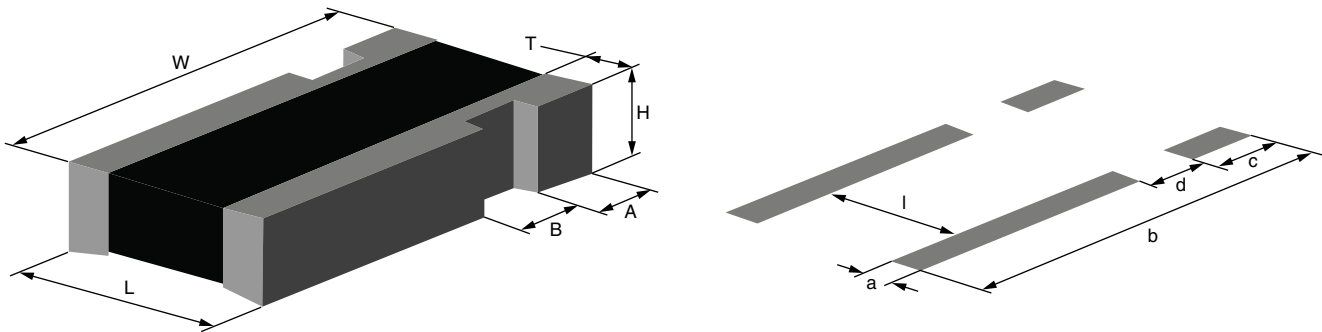
DIMENSIONS

Note

- Surface-mount solder profile recommendations: www.vishay.com/doc?31052

MODEL	DIMENSIONS in inches (millimeters)					
	L	W	H	T	A	B
WSKW0612	0.060 ± 0.010 (1.50 ± 0.254)	0.120 ± 0.010 (3.05 ± 0.254)	0.018 ± 0.010 (0.457 ± 0.254)	0.015 ± 0.010 (0.381 ± 0.254)	0.020 ± 0.005 (0.51 ± 0.127)	0.020 ± 0.005 (0.51 ± 0.127)

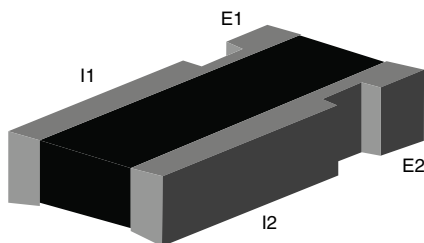
MODEL	SOLDER PAD DIMENSIONS in inches (millimeters)				
	a	b	c	d	l
WSKW0612	0.040 (1.01)	0.135 (3.43)	0.030 (0.762)	0.015 (0.381)	0.030 (0.76)

4 TERMINAL KELVIN CONNECTIONS

Notes

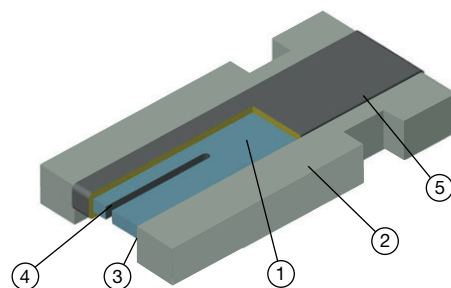
- E1 and E2: voltage sense connection
- I1 and I2: current connection

CONSTRUCTION OUTLINE

Notes

1. Resistive element: Mn-Cu
2. Terminal: solid copper and element with 100 % Sn finish
3. Terminal to element weld
4. Laser calibration
5. High temperature encapsulant: siliconized polyester coating material

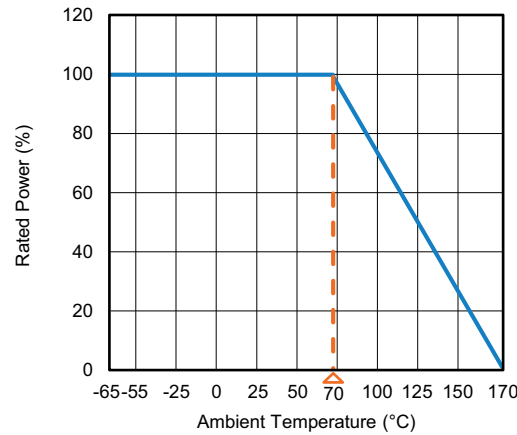

DERATING



PULSE CAPABILITY

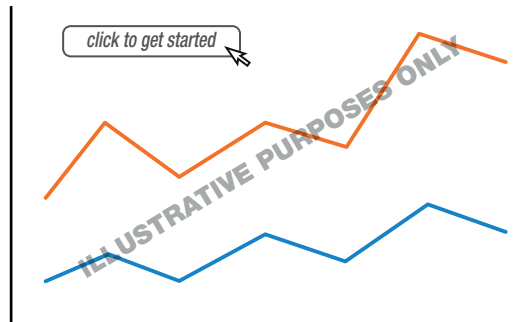

www.vishay.com/resistors/power-metal-strip-calculator

PERFORMANCE			
TEST	CONDITIONS OF TEST	TEST LIMITS	TYPICAL
Thermal shock	-55 °C to +150 °C, 1000 cycles, 15 min at each extreme	± 1.0 %	0.20 %
Low temperature storage	-65 °C for 24 h	± 0.5 %	0.1 % (24 h)
High temperature exposure	1000 h at +170 °C	± 1.0 %	± 0.2 %
Bias humidity	+85 °C, 85 % RH, 10 % bias, 1000 h	± 0.5 %	0.20 %
Mechanical shock	100 g's for 6 ms, 5 pulses	± 0.5 %	0.01 %
Vibration	Frequency varied 10 Hz to 2000 Hz in 1 min, 3 directions, 12 h	± 0.5 %	0.01 %
Load life	2000 h at +70 °C, 1.5 h "ON", 0.5 h "OFF"	± 1.0 %	-0.20 %
Resistance to solder heat	+260 °C solder, 10 s to 12 s dwell, 25 mm/s emergence	± 0.5 %	0.05 %
Moisture resistance	MIL-STD-202, method 106, 0 % power, 7b not required	± 1.0 %	0.01 %



PACKAGING (1)				
MODEL	REEL			
	TAPE WIDTH	DIAMETER	PIECES/REEL	CODE
WSKW0612	8 mm / embossed plastic	178 mm / 7"	4000	EA

Notes

- Embossed carrier tape per EIA-481
- (1) Additional packaging details at www.vishay.com/doc?20051

REEL ORIENTATION

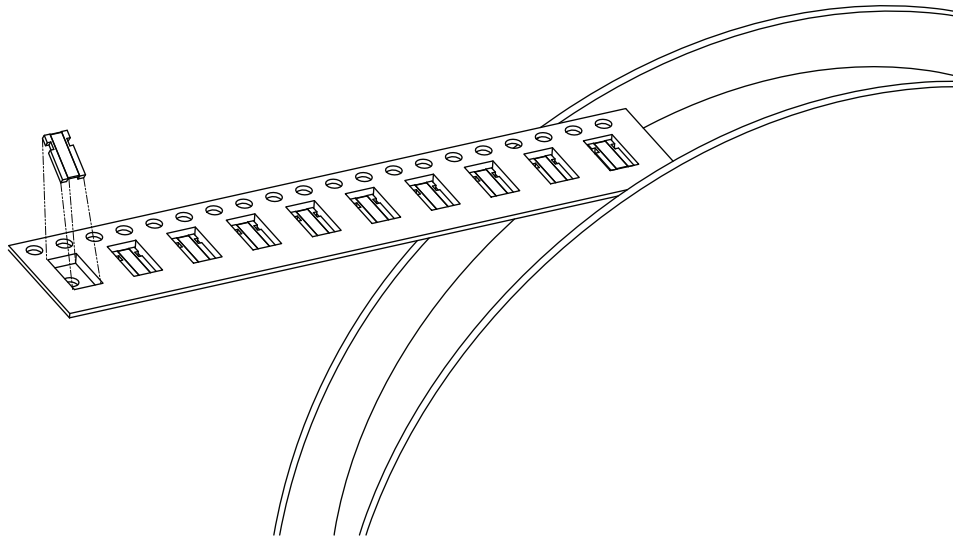



Disclaimer

ALL PRODUCT, PRODUCT SPECIFICATIONS AND DATA ARE SUBJECT TO CHANGE WITHOUT NOTICE TO IMPROVE RELIABILITY, FUNCTION OR DESIGN OR OTHERWISE.

Vishay Intertechnology, Inc., its affiliates, agents, and employees, and all persons acting on its or their behalf (collectively, "Vishay"), disclaim any and all liability for any errors, inaccuracies or incompleteness contained in any datasheet or in any other disclosure relating to any product.

Vishay makes no warranty, representation or guarantee regarding the suitability of the products for any particular purpose or the continuing production of any product. To the maximum extent permitted by applicable law, Vishay disclaims (i) any and all liability arising out of the application or use of any product, (ii) any and all liability, including without limitation special, consequential or incidental damages, and (iii) any and all implied warranties, including warranties of fitness for particular purpose, non-infringement and merchantability.

Statements regarding the suitability of products for certain types of applications are based on Vishay's knowledge of typical requirements that are often placed on Vishay products in generic applications. Such statements are not binding statements about the suitability of products for a particular application. It is the customer's responsibility to validate that a particular product with the properties described in the product specification is suitable for use in a particular application. Parameters provided in datasheets and / or specifications may vary in different applications and performance may vary over time. All operating parameters, including typical parameters, must be validated for each customer application by the customer's technical experts. Product specifications do not expand or otherwise modify Vishay's terms and conditions of purchase, including but not limited to the warranty expressed therein.

Hyperlinks included in this datasheet may direct users to third-party websites. These links are provided as a convenience and for informational purposes only. Inclusion of these hyperlinks does not constitute an endorsement or an approval by Vishay of any of the products, services or opinions of the corporation, organization or individual associated with the third-party website. Vishay disclaims any and all liability and bears no responsibility for the accuracy, legality or content of the third-party website or for that of subsequent links.

Except as expressly indicated in writing, Vishay products are not designed for use in medical, life-saving, or life-sustaining applications or for any other application in which the failure of the Vishay product could result in personal injury or death. Customers using or selling Vishay products not expressly indicated for use in such applications do so at their own risk. Please contact authorized Vishay personnel to obtain written terms and conditions regarding products designed for such applications.

No license, express or implied, by estoppel or otherwise, to any intellectual property rights is granted by this document or by any conduct of Vishay. Product names and markings noted herein may be trademarks of their respective owners.